

CONTENTS

Safety Precautions and Instructions	5
Basic Safety Recommendations	5
Unpacking and Inspection	6
Rigging, Lifting and Moving Large Units	6
System Description	8
Operating Principle	8
Amplifier Mounting Configuration Options	8
Meter Mounted Configuration	8
Remote Mount Configuration.	8
Submersible Option.	8
Meter Location, Orientation and Applications	9
Remote Option	9
Temperature Ranges	9
Protection Class	10
Pipelines and Fluid Flow	10
Meter Orientation	11
Vertical Placement.	11
Horizontal Placement.	11
Straight Pipe Requirements	11
Pipe Reducer Requirements	12
Chemical Injection Applications	12
Partially-Filled Pipe Situations.	13
Meter Gaskets and Grounding	14
Meter/Pipeline Connection Gaskets	14
Meter Grounding	14
Conductive Pipe Grounding.	14
Non-Conductive Pipe Grounding	15
Pipelines with Cathodic Protection	15
Electrically Disturbed Environment	15
Wiring.	16
Wiring Safety	16
Opening the Cover.	16
Power.	17
Battery	17

Battery Life	17
Battery Replacement	17
Battery Backup	18
Installation	19
Remote Mount Installation	19
Signal Cable Specification	21
Configuring Input/Output (I/O)	22
Circuit Board Diagram	22
User Interface	24
Function Buttons	24
Access the Programming Menu	24
Display	25
M5000 Main Menu Programming Options	26
Navigating the Initial Main Screens	26
Menu Structure	27
Programming Menus	30
Meter Setup Menu	30
Measure Menu	31
Inputs/Outputs Menu	33
Communication Menu	35
Battery Menu	36
Miscellaneous Menu	37
Information Menu	38
Faults Menu	38
Security	39
Setting a PIN	39
Activating the Security Feature	39
Logging In	40
Logging Out	40
PIN Menu	40
Advanced Moving Average Flow Filtering	41
Introduction	41
Definition	41
Explanation	42
Configuration of Average Length and Acceleration Factor	43
Maintenance	45

Cleaning the Flow Tube and Electrode	45
Replacing Circuit Board.	45
Troubleshooting	46
Errors and Warnings.	47
Connecting an ORION RTR® Endpoint to the M5000 Meter	48
Wiring.	48
Programming	48
Connecting an ORION Encoder Endpoint to the M5000 Meter	49
Wiring.	49
Programming	49
Specifications.	50
M5000 Amplifier	50
M5000 Amplifier Dimensions in Inches (Millimeters)	50
Detector Type VI	51
Flange ANSI Class 150 ASME B16.5	52
Flange ANSI Class 300 ASME B16.5	52
Flange EN 1092-1 / PN 10	53
Flange EN 1092-1 / PN 16	53
Flange EN 1092-1 / PN 25	53
Flange EN 1092-1 / PN 40	54
Error Limits.	55
OIML Approved Meter	56
MID Approved Meter (MI-001)	57
Replacement Parts.	58

SAFETY PRECAUTIONS AND INSTRUCTIONS

Some procedures in this manual require special safety considerations. In such cases, the text is emphasized with the following symbols:

⚠ DANGER Indicates a hazardous situation, which, if not avoided, *will* result in death or serious personal injury.

⚠ WARNING Indicates a hazardous situation, which, if not avoided, *could* result in death or serious personal injury.

⚠ CAUTION Indicates a hazardous situation, which, if not avoided, *could* result in minor or moderate personal injury or damage to property.

Basic Safety Recommendations

Before installing or using this product, read this instruction manual thoroughly. Only qualified personnel should install and/or repair this product. If a fault appears, contact your distributor.

The electromagnetic flow meter is only suitable for the measurement of conductive fluids. The manufacturer is not liable for damages that result from improper use or from use that is not in accordance with the requirements.

The meters are constructed according to state-of-the-art technology and tested operationally reliable. They have left the factory in a faultless condition concerning safety regulations.

Installation

- Do not place any unit on an unstable surface that may allow it to fall.
- Never place the units above a radiator or heating unit.
- Route all cabling away from potential hazards.
- Isolate from the mains before removing any covers.
- Avoid exposing open cable ends to water/moisture (for example, in chambers), as this can penetrate into the cable and cause electrical short circuits.

Setup and Operation

Adjust only those controls that are covered by the operating instructions. Improper adjustment of other controls may result in damage, incorrect operation or loss of data.

Repair of Faults

Disconnect all units from power supply and have it repaired by a qualified service person if any of the following occurs:

- If a unit does not operate normally when operating instructions are followed
- If a unit exposed to rain/water or if any liquid has been spilled into it
- If a unit has been dropped or damaged
- If a unit shows a change in performance, indicating a need for service
- If the connections for any cable have been exposed to rain/water allowing moisture ingress into the cable itself

RoHs

Our products are RoHs compliant.

Battery Disposal

The batteries contained in our products need to be disposed of per your local legislation according to EU directive 2006/66/EG.

UNPACKING AND INSPECTION

Follow these guidelines when unpacking the equipment.

- If a shipping container shows any sign of damage, have the shipper present when you unpack the meter.
- Follow all unpacking, lifting and moving instructions associated with the shipping container.
- Open the container and remove all packing materials. Store the shipping container and packing materials in the event the unit needs to be shipped for service.
- Verify that the shipment matches the packing list and your order form.
- Inspect the meter for any signs of shipping damage, scratches, or loose or broken parts.

NOTE: If the unit was damaged in transit, it is your responsibility to request an inspection report from the carrier within 48 hours. You must then file a claim with the carrier and contact Badger Meter for appropriate repairs or replacement.

- All detectors with polytetrafluoroethylene (PTFE) liners are shipped with a liner protector on each end to maintain proper form of the PTFE material during shipping and storage.

NOTE: Do not remove the liner protectors until you are ready to install.

- Storage: If the meter is to be stored, place it in its original container in a dry, sheltered location. Storage temperature ranges are: $-40 \dots 160^{\circ}\text{F}$ ($-40 \dots 70^{\circ}\text{C}$).

Rigging, Lifting and Moving Large Units

⚠ CAUTION

WHEN RIGGING, LIFTING OR MOVING LARGE UNITS, FOLLOW THESE GUIDELINES:

- DO NOT lift or move a meter by its amplifier, junction box or cables.
- Use a crane rigged with soft straps to lift and move meters with flow tubes that are between two inches and eight inches (50 mm and 200 mm). Place the straps around the detector body, between the flanges, on each side of the detector.
- Use the lifting lugs when lifting meter flow tubes that are 10 inches (250 mm) in diameter or larger.

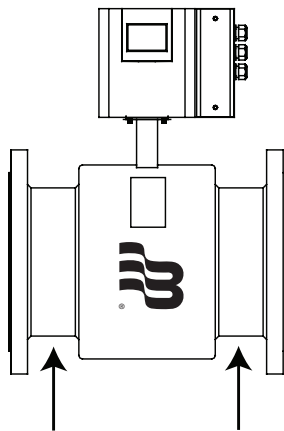

Place straps between flanges.

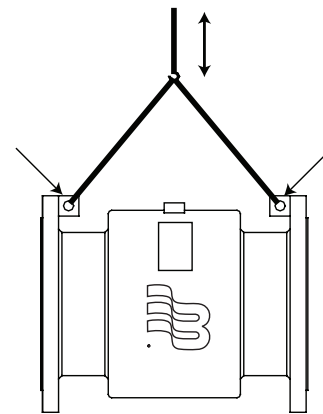

Use lifting lugs with 10-inch or larger meters.

Figure 1: Rigging large units

- Use the sling-rigged method to lift large detectors into a vertical position while they are still crated. Use this method to position large detectors vertically into pipelines.

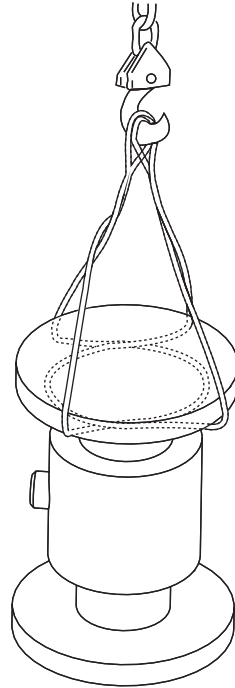
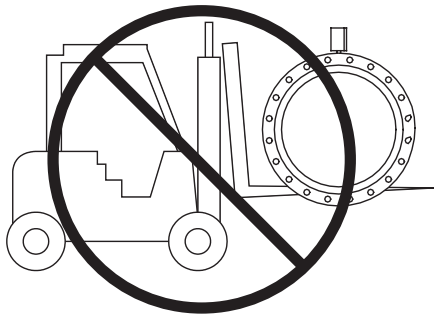
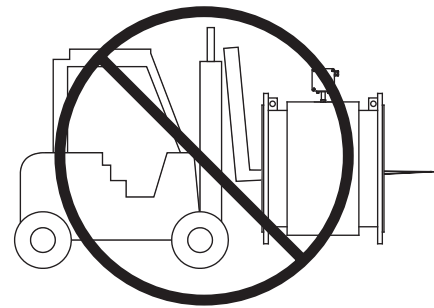

Figure 2: Sling-rigged lifting methods

- Do not lift a detector with a forklift by positioning the detector body on the forks, with the flanges extending beyond the lift. This could dent the housing or damage the internal coil assemblies.
- Never place forklift forks, rigging chains, straps, slings, hooks or other lifting devices inside or through the detector's flow tube to hoist the unit. This could damage the isolating liner.



Do not lift detector with forklift.



Do not lift or rig lifting devices through detector.

Figure 3: Lifting and rigging cautions

SYSTEM DESCRIPTION

The Badger Meter model M5000 electromagnetic flow meter is intended for fluid metering in most industries including potable water, reclaimed water, food and beverage, pharmaceutical and chemical. The meter can measure all fluids with electric conductivity of at least 5 $\mu\text{S}/\text{cm}$ (20 $\mu\text{S}/\text{cm}$ for demineralized water) and is highly accurate. Measuring results depend on density, temperature and pressure.

The basic components of an electromagnetic flow meter are:

- The **detector**, which includes the flow tube, isolating liner and measuring electrodes.
- The **amplifier**, which is the electronic device responsible for the signal processing, flow calculation, display and output signals.

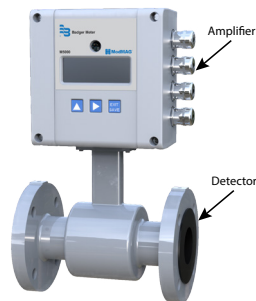

Figure 4: Amplifier and detector

The construction materials of the wetted parts (liner and electrodes) should be appropriate for the specifications on the intended type of service. We recommend that you review all of the compatibilities consistent with the specifications.

Each meter is factory tested and calibrated. A calibration certificate is included with each meter.

OPERATING PRINCIPLE

In accordance with Faraday's induction principle, electric voltage is induced in a conductor moving through a magnetic field. In case of the electromagnetic flow measurement, the moving conductor is replaced by the flowing fluid. Two opposite measuring electrodes conduct the induced voltage which is proportional to flow velocity to the amplifier. Flow volume is calculated based on pipe diameter.

AMPLIFIER MOUNTING CONFIGURATION OPTIONS

Meter Mounted Configuration

The meter mount configuration has the amplifier mounted directly on the detector. This compact, self-contained configuration minimizes installation wiring.

Remote Mount Configuration

The remote mount configuration places the amplifier at a location away from the fluid flow and detector. This is necessary in situations where process fluid temperature or the environment exceeds amplifier ratings.

The detector and amplifier are connected by wires, run through conduit, between junction boxes on the detector and the amplifier. The distance between the detector junction box and amplifier junction box can be up to 100 feet (30 meters). A remote mounting bracket is supplied.

Submersible Option

If you are installing the meter in a vault, order the remote amplifier option. Do not install the amplifier inside a vault. We also recommend ordering the remote meter package with the submersible option (NEMA 6P/IP68) to eliminate any potential problems resulting from humidity or temporary flooding in the vault.

NOTE: NEMA 6P/IP68 enclosures are constructed for indoor or outdoor use to provide protection against access to hazardous parts, and to provide a degree of protection against ingress of solid foreign objects and water (hose directed water and the entry of water during prolonged submersion at a limited depth). They provide an additional level of protection against corrosion and are not damaged by the external formation of ice on the enclosure.

METER LOCATION, ORIENTATION AND APPLICATIONS

The M5000 provides two amplifier mounting options: a meter mounted option and a remote option.

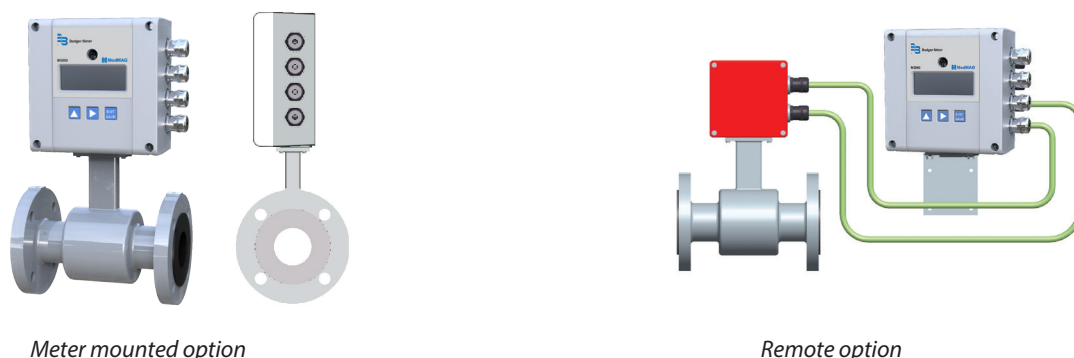

Figure 5: Amplifier mounting options

Remote Option

Use a remote amplifier in the following situations:

- Detector protection class IP 68
- Detector to be mounted in a vault (see note on previous page)
- Fluid temperature is greater than 212° F (100° C)
- Strong vibrations at meter location

Remote Amplifier Outdoor Location

The amplifier can be installed and operated outdoors. However, it must be protected from the elements, as follows:

- The ambient environment/temperature rating for the unit is $-4...140^{\circ}\text{F}$ ($-20...60^{\circ}\text{C}$).
- If an indoor location is within 100 feet (30 meters) of the detector, consider increasing the cable length (up to 100 ft) and mounting the amplifier indoors.
- At minimum, fabricate a roof or shield over and/or around the amplifier to protect the LCD display screen from direct sunlight.
- Do not install the signal cable close to power cables, electric machines, and more.
- Secure the signal cables. Due to capacity changes, cable movements may result in incorrect measurements.

Temperature Ranges

- To prevent the meter from any damage, strictly observe the amplifier's and detector's maximum temperature ranges.
- In regions with extremely high ambient temperatures, it is recommended to protect the detector.
- In cases where fluid temperature exceeds 212° F (100° C), use the remote amplifier option.

Amplifier	Ambient temperature	$-4...140^{\circ}\text{F}$ ($-20...60^{\circ}\text{C}$)
Detector	Fluid temperature	PTFE / PFA $-40...302^{\circ}\text{F}$ ($-40...150^{\circ}\text{C}$)
		Hard rubber $32...176^{\circ}\text{F}$ ($0...80^{\circ}\text{C}$)

Protection Class

The device has protection class IP 67, optional IP 68. In order to fulfill requirements in respect of the protection class, follow these guidelines:

- Body seals must be undamaged and in proper condition.
- All of the body screws must be firmly screwed.
- Outer diameters of the used wiring cables must correspond to cable inlets (for M20 Ø 7...12 mm). In cases where cable inlet is not used, put on a dummy plug.
- Tighten cable inlets.
- If possible, lead the cable downwards to avoid humidity going into cable inlet.
- We normally deliver the meter in accordance with protection class IP 67. If you require a higher protection class, use the remote version. If requested, we can also deliver the detector in IP 68.

Pipelines and Fluid Flow

Take the following precautions during installation:

- Do not install the meter on pipes with extreme pipe vibrations. If pipes are vibrating, secure the piping with appropriate pipe supports in front of and behind the meter. If vibrations cannot be restrained, mount the amplifier in a remote location.
- Do not install the detector close to pipeline valves, fittings or impediments that can cause flow disturbances.
- For detectors with PTFE liners, do not install the detector on suction sides of pumps.
- Do not install the detector on outlet sides of piston or diaphragm pumps. Pulsating flow can affect meter performance.
- Avoid installing the detector near equipment that produces electrical interference such as electric motors, transformers, variable frequency and power cables.
- Verify that both ends of the signal cables are securely fastened.
- Place power cables and signal cables in separate conduits. Do not install the signal cable close to other sources of electricity, such as power cables or electric machines.
- Place the meter where there is enough access for installation and maintenance tasks.

Meter Orientation

Mag meters can operate accurately in any pipeline orientation and can measure volumetric flow in forward and reverse directions, as long as the pipe is completely full.

NOTE: A "Forward Flow" direction arrow is printed on the detector label.

Vertical Placement

Mag meters perform best when placed vertically, with liquid flowing upward and meter electrodes in a closed, full pipe.

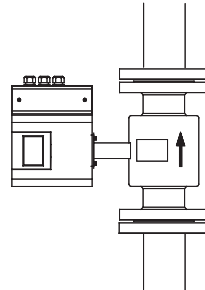

Figure 6: Vertical placement

Vertical placement allows the pipe to remain completely full, even in low flow, low pressure applications, and it prevents solids build-up, sediment deposit and accumulation on the liner and electrodes.

NOTE: Carefully observe the "Forward Flow" label on the meter body and install the meter accordingly. When installed vertically, rotate amplifier so that cable glands are facing down.

Horizontal Placement

M5000 meters are equipped with an *Empty Pipe Detection* feature. If an empty pipe electrode mounted in the pipe is not covered by fluid for five seconds, the meter displays an Empty Pipe Detection condition. The meter sends out an error message and stops measuring flow. When the electrode is again covered with fluid, the error message disappears and the meter resumes measuring.

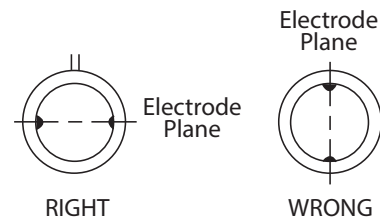

Figure 7: Horizontal placement

When installing the meter on a horizontal pipe, mount the detector to the pipe with the flow-measuring electrode axis in a horizontal plane (three and nine o'clock). This placement helps prevent solids build-up, sediment deposit and accumulation on the electrodes.

Straight Pipe Requirements

Sufficient straight-pipe runs are required at the detector inlet and outlet for optimum meter accuracy and performance. An equivalent of 3...7 diameters of straight pipe is required on the inlet (upstream) side to provide a stable flow profile. Two diameters are required on the outlet (downstream) side.

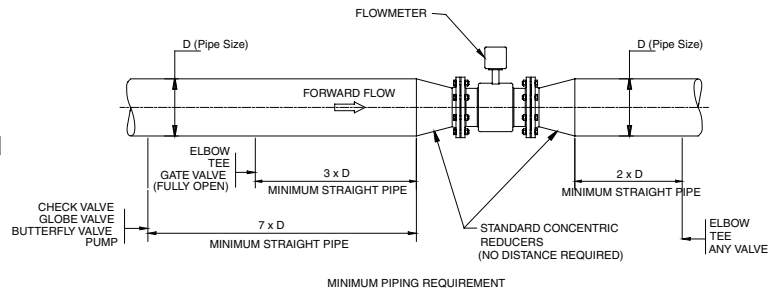

Figure 8: Straight pipe requirements

Pipe Reducer Requirements

With pipe reducers, a smaller meter can be mounted in larger pipelines. This arrangement may increase low-flow accuracy. There are no special requirements for standard, concentric pipe reducers.

Custom fabricated pipe reducers must have a maximum slope angle of 8 degrees to minimize flow disturbances and excessive loss of head. If this is not possible, install the custom pipe reducers as if they were fittings and install the required amount of straight pipe.

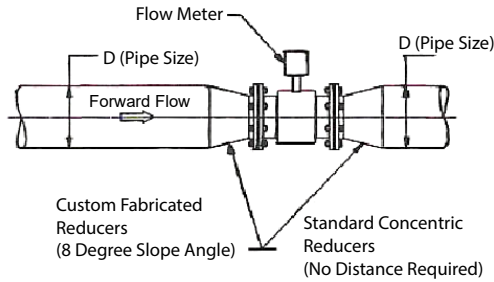

Figure 9: Pipe reducer requirements

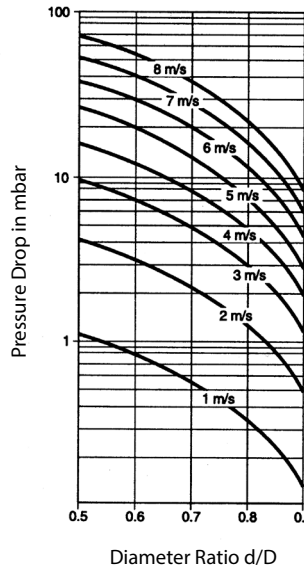

Figure 10: Pressure loss chart

Chemical Injection Applications

For water line applications with a chemical injection point, install the meter upstream of the injection point. This eliminates any meter performance issues.

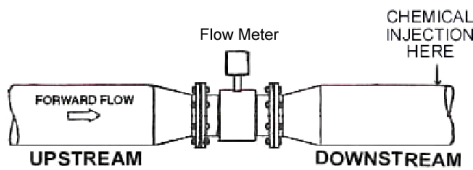

Figure 11: Chemical injection point downstream of meter

If a meter must be installed downstream of a chemical injection connection, the distance between the flange and the injection point should be between 50 and 100 feet (15 and 30 meters). The distance must be long enough to allow the water or chemical solution to reach the meter in a complete, homogeneous mixture.

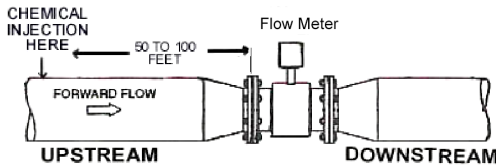

Figure 12: Chemical injection point upstream of meter

If the injection point is too close, the meter senses the two different conductivities for each liquid. This can cause inaccurate measurements. The injection method—spaced bursts, continuous stream of drips, liquid or gas—can also affect downstream readings by the meter.

Partially-Filled Pipe Situations

In some locations, the process pipe may be momentarily only partially filled. Examples include: lack of back pressure, insufficient line pressure and gravity flow applications.

To eliminate these situations:

- Do not install the meter at the highest point of the pipeline.
- Do not install the meter in a vertical, downward flow section of pipe.
- Always position the ON/OFF valves on the downstream side of the meter.
- Turn ON *Empty Pipe* for applications or installations where the pipe is sometimes empty.
- Do not install the detector on the suction side of pumps. This could damage the liner (in particular PTFE liners).
- Do not install the detector on pipes with vibrations. If pipes are strongly vibrating, use a remote version.

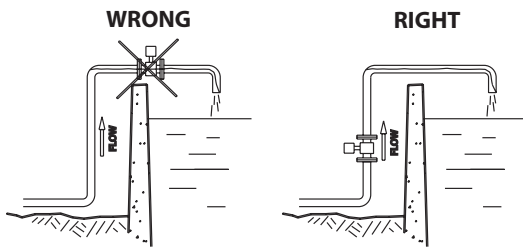
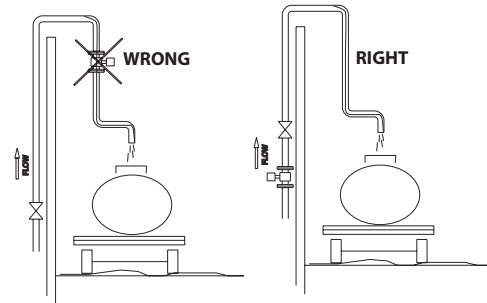

Figure 13: Incorrect meter placement



Do not install in a vertical, downward position.

Position "On/Off" valves on downstream side.

Figure 14: Position valves on downstream side

To minimize the possibility of partially-full pipe flows in horizontal, gravity or low pressure applications, create a pipe arrangement that allows the detector to remain full of liquid at all times.

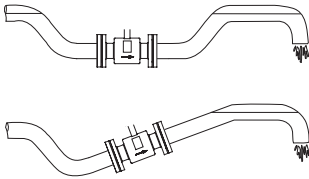

Figure 15: Pipe positioned to keep water in detector

METER GASKETS AND GROUNDING

Consider gasket and grounding requirements when determining the meter location, orientation and application. Ground all units to eliminate risk of electric shock.

⚠ CAUTION

FAILURE TO PROPERLY GROUND A UNIT MAY CAUSE DAMAGE TO THAT UNIT OR DATA STORED WITHIN IT.

Meter/Pipeline Connection Gaskets

Install gaskets (not provided) between the detector's isolating liner and the pipeline flange to ensure a proper and secure hydraulic seal. Use gaskets that are compatible with the fluid. Center each gasket on the flange to avoid flow restrictions or turbulence in the line.

During installation, do not use graphite or any electrically conductive sealing compound to hold the gaskets. This could compromise the accuracy of the measuring signal.

If you are using a grounding ring (as Badger Meter recommends) in the detector/pipeline connection, place the ring between two gaskets. (See ["Non-Conductive Pipe Grounding"](#) on page 15.)

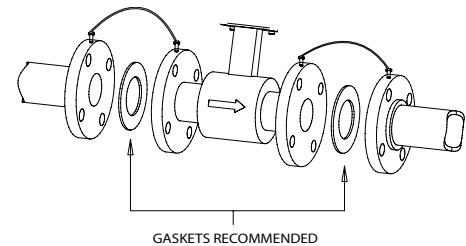

Figure 16: Meter/pipeline connection gaskets

Meter Grounding

Process pipeline material can be either electrically conductive (metal) or not electrically conductive (made of or lined with PVC, fiberglass or concrete).

IMPORTANT

It is essential that the mag meter amplifier's input ground (zero voltage reference) be electrically connected to the liquid media and to a good, solid earth ground reference.

Potential Equalization

In order to obtain an accurate measurement, detector and fluid need to be on the same electric potential.

If flange or intermediate flange versions with additional grounding electrode are used, grounding is provided by the connected pipeline.

- If a type of meter with a flange connection cable (min. 4 mm²) between the grounding screw on the meter's flange and the counter flange is to be used in addition to the fixing screws, verify that the electric connection is complete.
- Color or corrosion on the counter flange may have a negative effect on the electric connection.

Conductive Pipe Grounding

To achieve an adequate ground, the meter body **MUST** be electrically connected to the liquid media. The mag meter flanges are provided with grounding bolts for this purpose.

If the pipe material is electrically conductive, simply install grounding straps between these grounding bolts and the mating flanges.

These grounding straps must be copper wire, at least 12 AWG size. They must be connected on both sides (inlet and outlet) of the detector and to a local, earth ground.

To provide a good electrical connection at the mating flanges, Badger Meter recommends that you drill and tap the flanges and install a grounding screw (not provided).

Non-Conductive Pipe Grounding

IMPORTANT

If the process pipe is not electrically conductive (PVC, fiberglass, cement-lined pipes or any other non-conductive material) and the meter was not originally ordered with an optional grounding electrode, you must install a pair of grounding rings between the mating flanges at both ends of the meter. See the following illustration.

In this case, connect the grounding straps to both of the grounding rings and to a good, solid earth ground. Grounding rings are available in stainless steel. If your fluid is too aggressive for stainless steel, order a meter with the optional grounding electrode in a material compatible with the fluid.

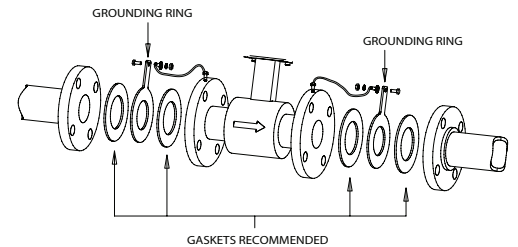

Figure 17: Non-conductive pipe grounding

Pipelines with Cathodic Protection

For pipelines with cathodic protection, install the meter potential-free. No electric connection from the meter to the pipeline system may exist and the power supply is to be provided via isolating transformer.

CAUTION

USE GROUNDING ELECTRODES. INSTALL GROUNDING RINGS ISOLATED FROM THE PIPELINE.

OBSERVE NATIONAL RULES REGARDING POTENTIAL-FREE INSTALLATIONS.

Electrically Disturbed Environment

If the pipe material is in an electrically disturbed environment or if metallic pipelines that are not grounded are used, we recommend a grounding as shown in the following picture in order to make sure that measurement is not influenced.

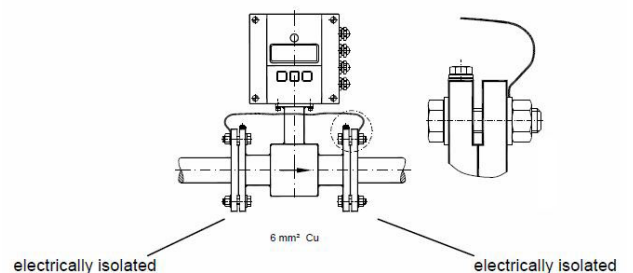

Figure 18: Potential-free installation

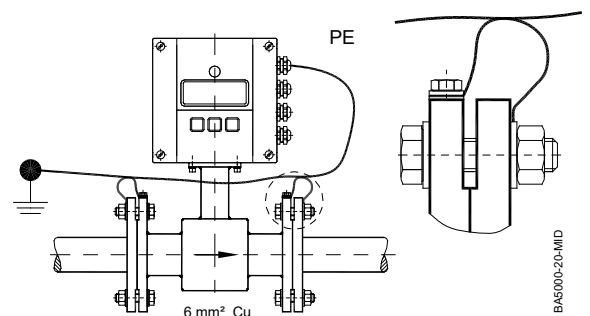

Figure 19: Grounding for electrically disturbed environment

WIRING

Wiring Safety

⚠ WARNING

- Disconnect power to the unit before attempting any connection or service.
- Do not bundle or route signal lines with power lines.
- Use twisted pair shielded wire for all output wiring.
- For the 4 × M20 cable inlets, only use flexible electric cables.
- Observe all applicable, local electrical codes.

Opening the Cover

The M5000 amplifier's design lets you open the cover without completely removing it.

Follow these steps:

1. Completely remove the top two screws from the amplifier using a blade/slotted screwdriver.
2. Loosen both of the bottom screws so that the round head of each screw clears the top face of the cover.
3. Pull the cover down to the open position.



Figure 20: Remove two screws



Figure 21: Open the cover

POWER

The M5000 can be powered with:

- Battery only (2 D-cells or 4 D-cells)
- 100...240V AC (with battery back-up)
- 9...36V DC (with battery back-up)

Battery

Use a two D-cell battery pack for sizes 1/2...6 in. (DN 15...150) or a double two D-cell battery pack for sizes 8...24 in. (DN 200...600). For backup battery options, see "[Battery Backup](#)" on page 18.

The meter is delivered with the battery unplugged. It must be plugged in before using the meter. The connection jack is located by the symbol "BAT" on the board.

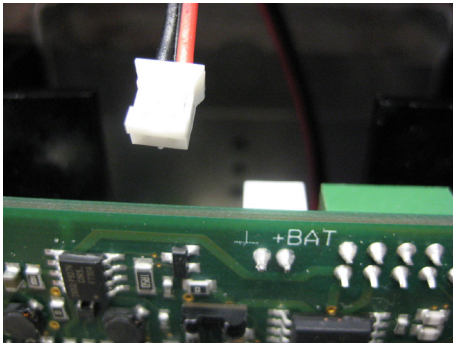

Figure 22: Battery connection

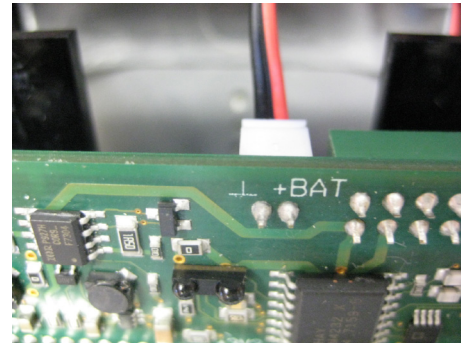

Figure 23: Battery plugged in

Battery Life

NOTE: The battery life strongly depends on ambient temperature, sampling rate and the number of outputs used.

Standard Battery Pack	
Sampling	Expected Life
1 s	8 months
4 s	2.7 years
8 s	5.3 years
15 s	10 years

These calculations are for a standard battery pack, with two D-size batteries, with communication and outputs OFF, at a temperature of 77° F (25° C). See "[Battery Level Indicators](#)" on page 25.

Battery Replacement

1. Go to *Main Menu > Misc > Battery > Change* and select the capacity of the battery pack to be installed (see label on the battery pack 19 Ah, 38 Ah or 70 Ah). Press **E** to quit. The display freezes (no reaction by pressing any button).
2. Open the cover.
3. Remove all connectors (detector and outputs).
4. Remove all 4 screws of the main board, remove the circuit board and disconnect the old battery.
5. Remove the old battery and wait about 2 minutes before replacing it with a new one (LCD display should be off).
6. Plug the battery connector into the back of the main board and reinstall the circuit board.
7. Replace all the plugs.
8. Close the cover tight.
9. Check time and date (*Main Menu > Misc > Time* and *Main Menu > Misc > Date DMY*).
10. Check capacity of battery (*Main Menu > Misc > Battery AH*). The first value is the used capacity, which should be 0.0. The second value is the capacity of the battery pack. *Battery AH* is a read-only parameter.

NOTE: Totalizers and configuration remain unaffected during battery replacement.

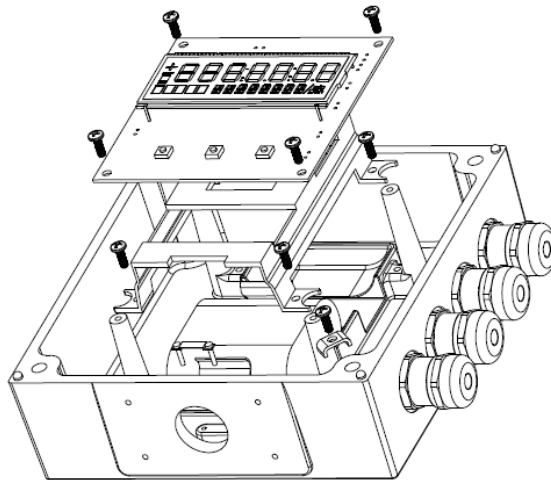

Figure 24: Amplifier housing components – exploded view

Battery Backup

The backup battery option allows the meter to run using the backup battery power in case of power loss. The meter ships with an unplugged backup battery. Make sure that any power cables are of a sufficiently high current rating. If in doubt, contact your distributor.

CAUTION

DO NOT INSTALL THE METER UNDER VOLTAGE

1. Connect the power supply according to the terminal marking.

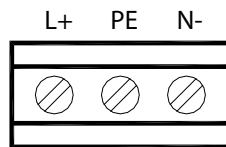

90...264V AC (50/60Hz)

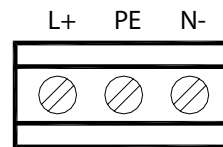

9...36V DC

NOTE: The safety fuse is soldered on the electronic board (1.6 A slow).

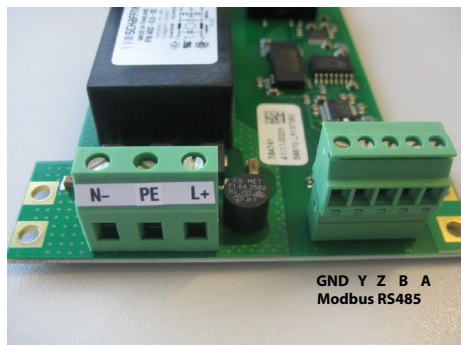

Figure 25: Power supply terminals

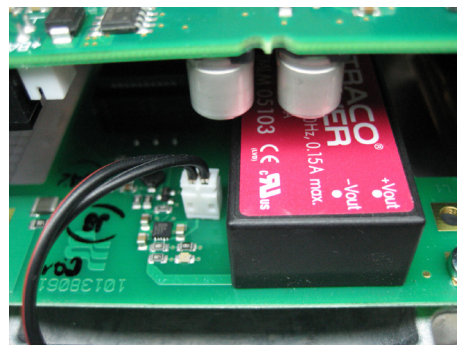

Figure 26: Backup battery location

2. Connect the battery to the connection socket on the power supply board. See [Figure 26](#).

NOTE: The board comes standard with Modbus RTU RS485 interface.

INSTALLATION

For detectors with PTFE liner, do not remove protective cap on the flange until shortly before installation.

Remote Mount Installation

Mount Bracket to Amplifier

1. Align bracket-mounting holes with amplifier mounting holes.
2. Attach bracket to amplifier with supplied screws. Torque the screws to 80 inch-pounds.

Wiring Configuration

Connection on the amplifier

1. Open the cover of the amplifier.
2. Push both cables through two different cable glands as shown in [Figure 27](#).

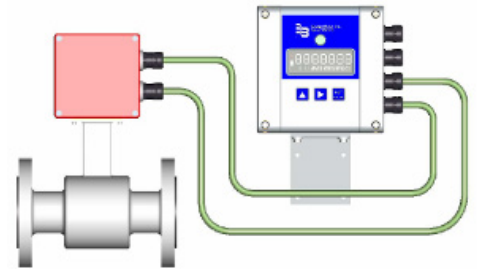

Figure 27: Cables in cable glands

3. The cable entry should be done as shown in [Figure 28](#).

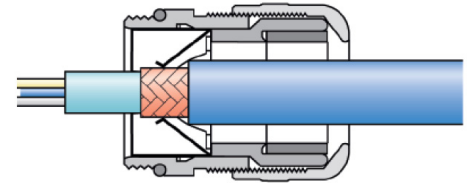

Figure 28: Cable entry

4. Connect the cables to the corresponding plugs on the left side of the board as shown in [Figure 29](#).
5. Close cover tight.

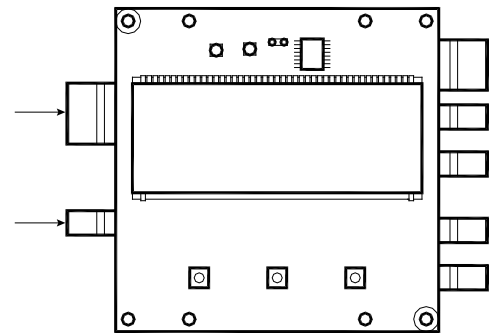

Figure 29: Cables to plugs

Connection on the detector

1. Loosen fixing screws of the connection cover and remove cover.
2. Push both cables through two different cable glands.
3. The cable entry should be done as shown in [Figure 30](#).

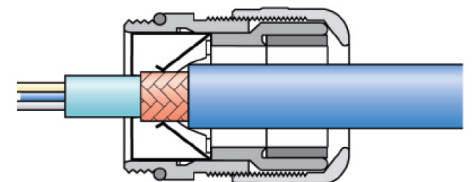

Figure 30: Cable entry

4. Connect the cables to the corresponding plugs on the left side of the board as shown in [Figure 31](#).
5. Close junction box cover again firmly.

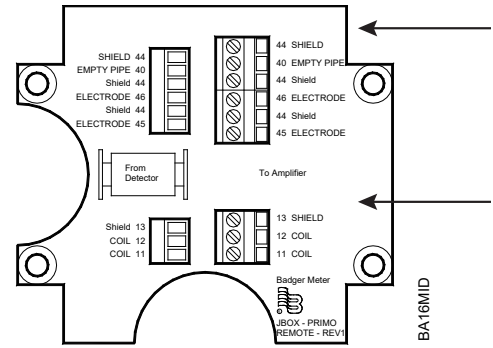

Figure 31: Cables to plugs

Wiring for Remote Configuration

Remote style M5000 amplifier models can be ordered with standard cables measuring 15, 30, 50 and 100 feet (5, 10, 15, and 30 m).

Junction Box			
Terminal		Description	Wire Color
11	C1	Coil C1	Brown
12	C2	Coil C2	White
13		N/A	Not Used
40	EP	Empty pipe detection	Red
44*	⏏	Shielding electrode	—
44*	⏏	Shielding electrode	Green
45	E1	Electrode E1	White
46	E2	Electrode E2	Black

*Connections with number 44 are on the same potential.

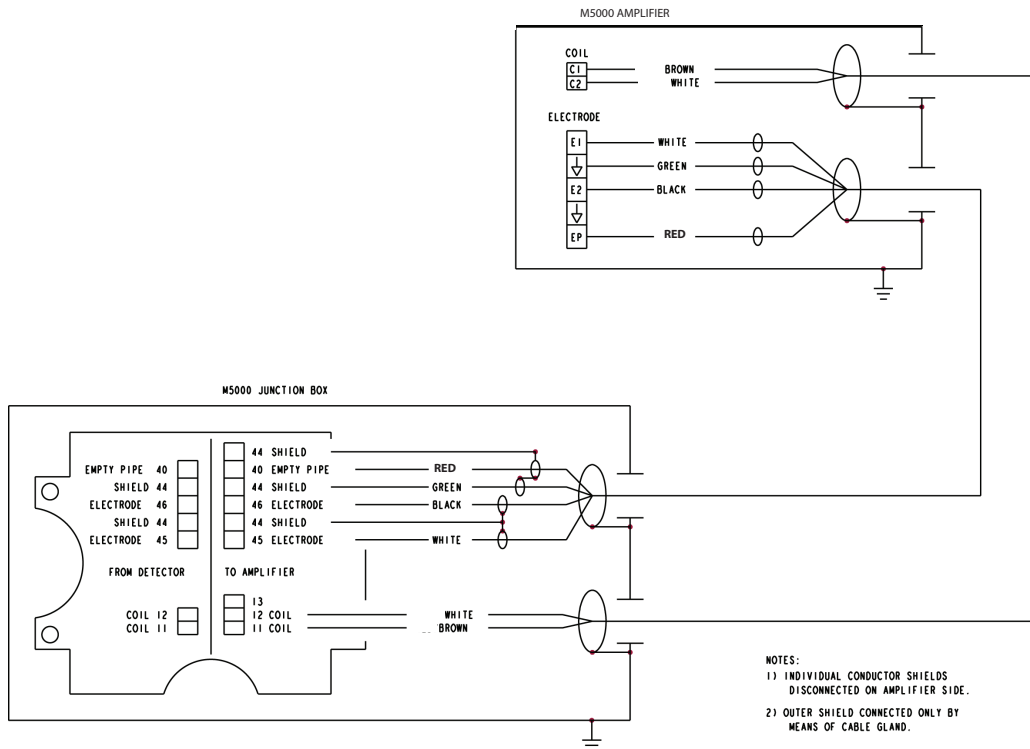
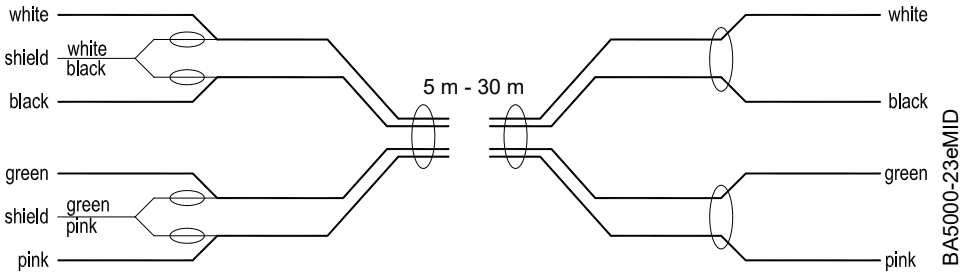

Figure 32: Wiring for remote configuration

Signal Cable Specification

- Only use signal cables delivered by Badger Meter or corresponding cable in accordance with the following specification.
- Take maximum signal cable length between detector and amplifier into account (keep distance as low as possible).

Electrode Cable		
Distance	Type	Capacity
Maximum 30 m	RGB DY 5 × Kx 0.4/1.8	60 nF/km
Temperature range -10 bis +80° C		



Coil Cable		
Distance	Type	Resistance
Maximum 30 m	1 × (2 × 0.34 mm ²)	< 115 Ω/km
PVC cable Typ Li2YCY (TP)		
Temperature range -5 bis +70° C		

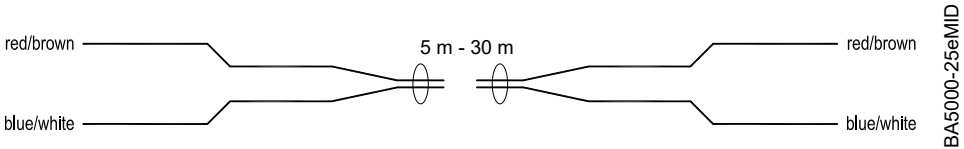

CONFIGURING INPUT/OUTPUT (I/O)

This section describes wiring the following M5000 outputs:

- Digital outputs
- Communication

When the sensor and the amplifier have been wired, wire any outputs to the M5000 amplifier.

Follow all of the safety precautions and local code to prevent electrical shock and damage to the electronic components.

Circuit Board Diagram

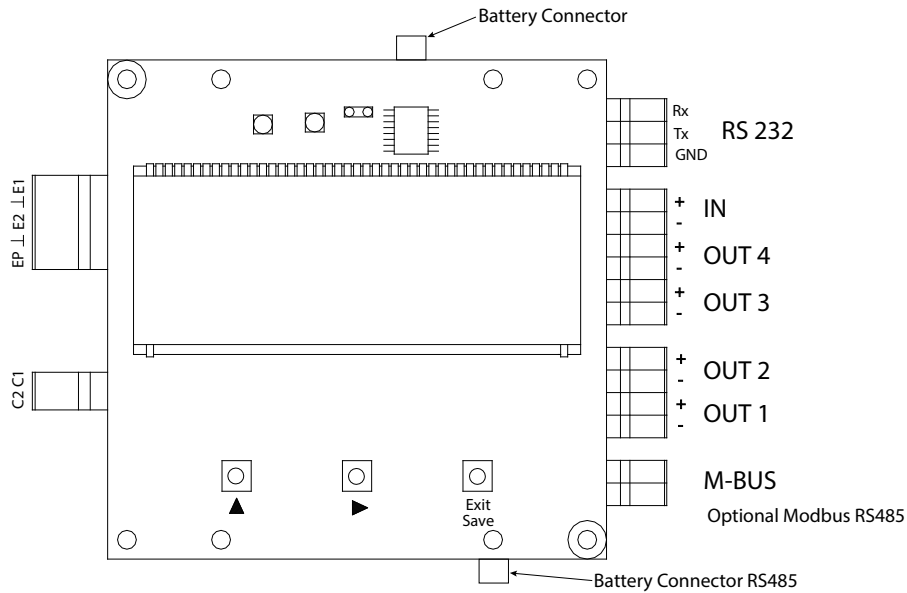

Figure 33: Configuring input/output

Input/Output	Description	Terminal
Output 1	Passive maximum 30V DC, 20 mA Maximum frequency 100 Hz	OUT1 (+) and (-)
Output 2	Passive maximum 30V DC, 20 mA Maximum frequency 100 Hz	OUT2 (+) and (-)
Output 3	Passive maximum 30V DC, 20 mA Maximum frequency 100 Hz	OUT3 (+) and (-)
Output 4	Passive maximum 30V DC, 20 mA Maximum frequency 100 Hz Can be used with digital input as an ADE interface.	OUT4 (+) and (-)
RS232	Modbus RTU	RxD, TxD, GND
IN	Digital input 3...35V DC	IN (+) and (-)
M-Bus ¹	M-Bus interface	No polarity
Optional Modbus RS485 ²	Modbus Interface Powered external 5...32V DC Optional internal by battery	GND, B-, A+, 12V

NOTE: ¹ For detailed information regarding the M-Bus interface, go to www.badgermeter.com in the Commercial & Industrial Solutions > Product Lines > ModMAG > M5000 > Product Documentation section.

NOTE: ² The M5000 meter also supports Modbus RTU RS485 communication. Modbus RTU communication options must be selected at time of order or can be ordered as a service part. See the "M5000 Modbus Communication Protocol Memory Map Application Data Sheet", available at www.badgermeter.com in the Commercial & Industrial Solutions > Product Lines > ModMAG > M5000 > Product Documentation section.

Jumper Location

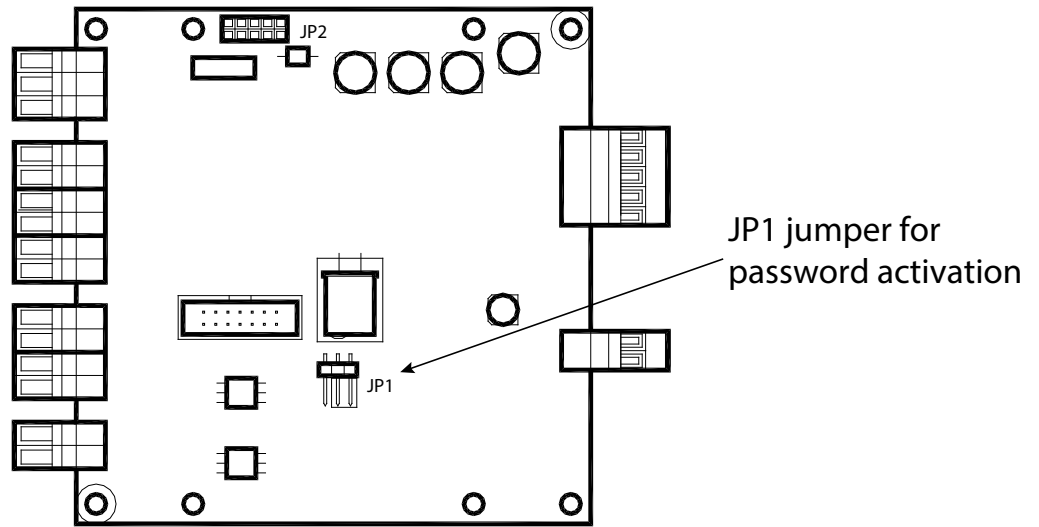

Figure 34: JP1 location

Digital Output Wiring Diagrams

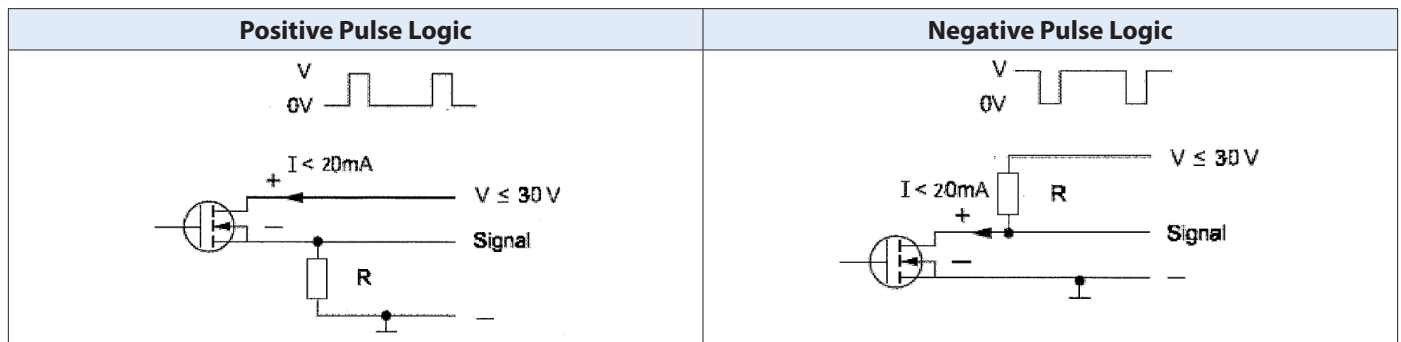

Figure 35: Digital output wiring diagram

Digital Output Selections

Output 1	Output 2	Output 3	Output 4
Forward Pulse Output	Reverse Pulse Output	Flow direction (Forward vs. Reverse)	ADE
Flow Setpoint (0...100% of full scale, resolution 1%)	Flow Setpoint (0...100% of full scale, resolution 1%)		
Empty pipe alarm	Empty pipe alarm		
Error alarm	Error alarm		
Off			
Test			
Can be used with AMR when the pulse width is set to 50 milliseconds.		—	

Outputs are configurable for Pulses/Unit (PPU) and Pulse Width (PW). The PW is configurable from 5...500 milliseconds, with a frequency limit of 100 Hz. PPU displays using an automatically selected resolution.

The high/low flow alarm functionality is configurable for maximum and minimum setpoints as a percentage of full-scale flow. Configurable values are settable from 0...100% in 1% increments.

USER INTERFACE

The M5000 amplifier is pre-programmed from the factory. No additional programming is necessary, however, for special features, the meter can be programmed for specific requirements.

Function Buttons

All M5000 programming is accomplished using the three function buttons located on the front of the amplifier. Screen navigation and digit and parameter selection is performed by a combination of these three buttons.



The **up-arrow** button allows scrolling through nine menu screens. This button is also used to advance numerical digits to change values, such as frequency, period and EP level as well as toggle on-off conditions and flow directions.

The **right-arrow** button allows digit selection from left to right and allows selecting either the top row of the display or the bottom row (the bottom row is active when flashing).

The **EXIT SAVE** button allows the saving of changed values and conditions, toggling between the upper and lower display lines and returning to a previous menu.

Access the Programming Menu

To access the measuring mode for parametering, please press the key **up-arrow** button as long as necessary until "Menue" is displayed on the second line.



Select Programming









Now press **right-arrow** button to select this menu point.

Display

The top row displays seven digits for specific values on each screen and the bottom row displays meter and register condition icons and current screen descriptions.





Icons

-  Battery status
-  Communication interface is activated (RS232, IrDA, M-Bus)
-  Meter is unlocked
-  Error message
-  Empty pipe detection
-  Battery back-up (external power supply)

Battery Level Indicators

The battery icon indicates three levels of capacity:

-  OK
-  Replacement of battery recommended
-  No measurement

M5000 MAIN MENU PROGRAMMING OPTIONS

The following M5000 programming options are available from the *Main Menu*:

- *Meter Setup*
- *Measure*
- *In/Out*
- *Communication*
- *Battery*
- *Miscellaneous*
- *Information*
- *Pin*
- *Faults*

The applicable security level for each menu option is indicated as follows:

 Administrative

 Service

 User

 Parameters indicated by the battery icon affect battery performance.

Navigating the Initial Main Screens

From the main display, press **EXIT/SAVE** to go back to the *Flow Rate* screen or press the **UP** arrow to scroll through the following:

Option	Description
Flow screen	Displays flow rate in selected units (for example, Gallons or Cubic Feet)
m/s	Displays flow in meter/second (factory programmed)
Percent	Percent of full scale flow
T1+	Total forward flow (in bidirectional mode)
T1-	Total reverse flow (in bidirectional mode)
T1N	Total net flow (in bidirectional mode)
T2+	Total forward flow (in bidirectional mode, non-resettable)
T2-	Total reverse flow (in bidirectional mode, non-resettable)
T2N	Total net flow (in bidirectional mode, non-resettable)
Login	Login when security is active
Main Menu	Access to Main Menu

Menu Structure

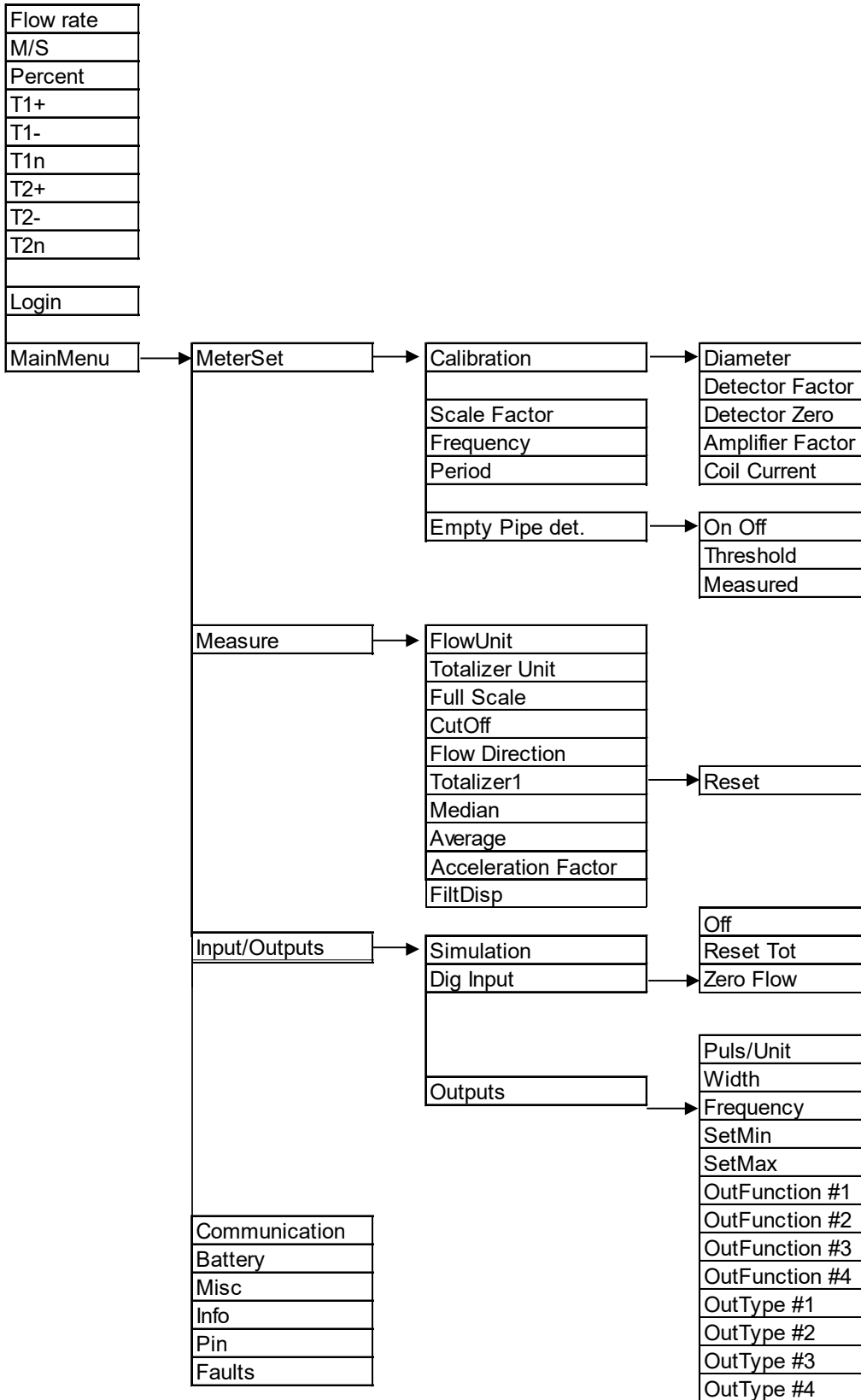

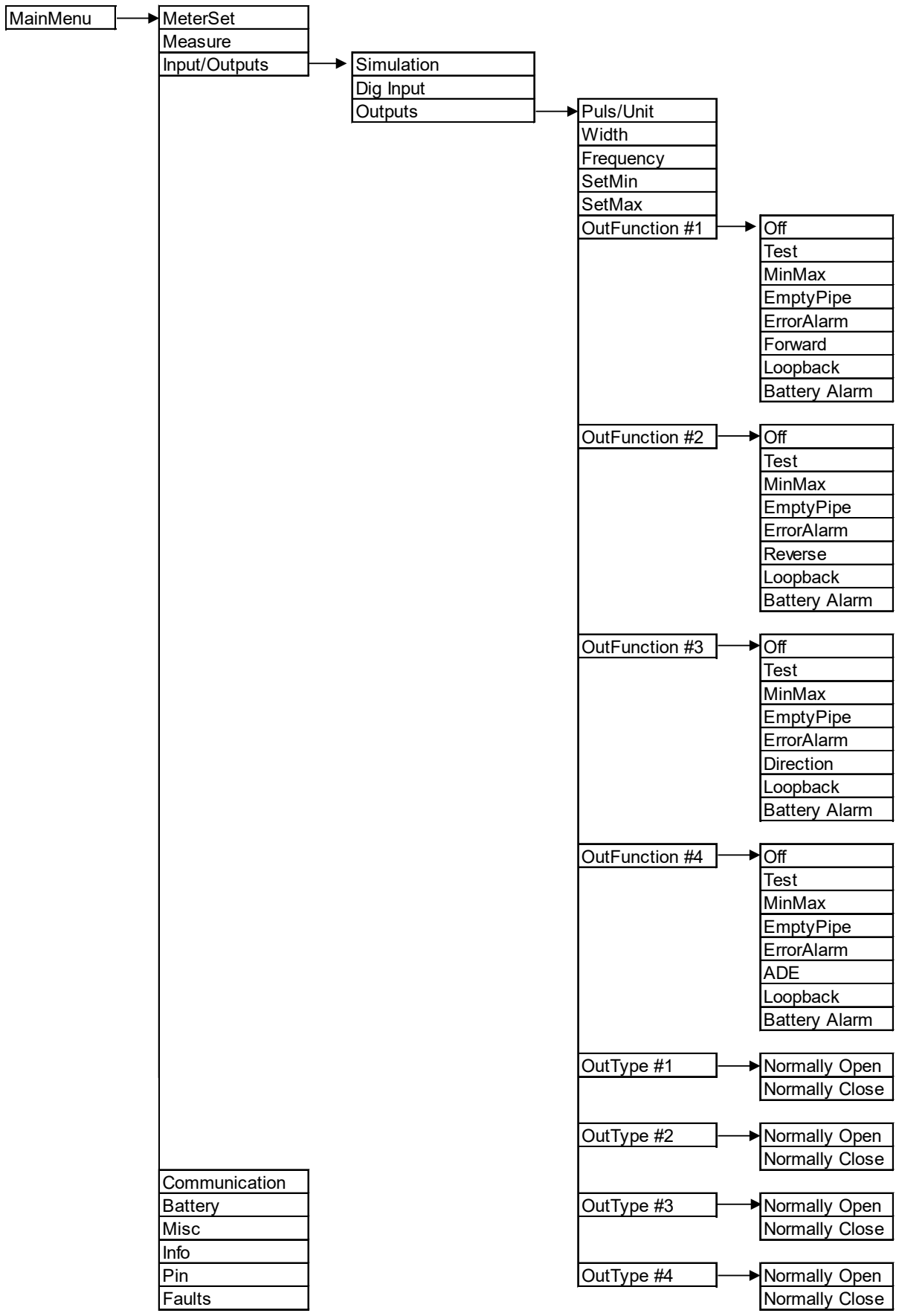

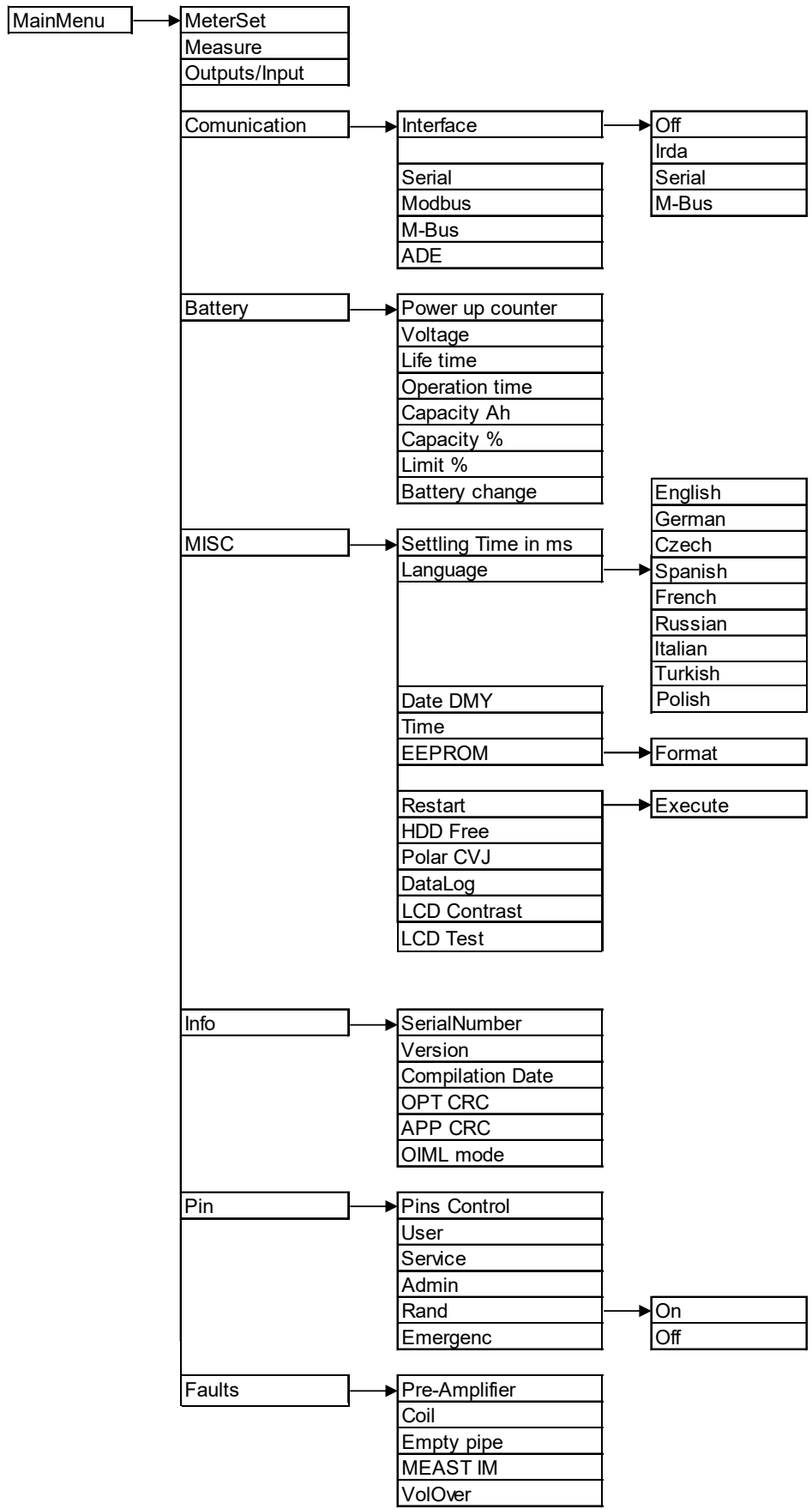















PROGRAMMING MENUS

Meter Setup Menu











Meter Setup		
Calibration	Diameter [Diameter] 	Factory set. In the event the amplifier is replaced, verify that the pipe diameter matches the installed pipe size.
	Detector Factor [Det Fact] 	Factory set. Compensates for accuracy error as a result of the installed detector. In the event the amplifier is replaced, this parameter must be reprogrammed with the original detector factor.
	Detector Zero [Det Zero] 	Factory set. Compensates for accuracy error as a result of the installed detector. In the event the amplifier is replaced, this parameter must be reprogrammed with the original detector zero.
	Amplifier Factor [Amp Fact] Read only	Factory set and Read Only. Compensates for accuracy error as a result of the installed amplifier.
	Coil Current [Coil Cur] Read only	Factory set and Read Only. Compensates for accuracy error as a result of the installed amplifier.
Scale Factor [Scale] 	Changing the scale factor lets you adjust the meter's accuracy without disturbing parameters set by the factory. You can tune the meter to meet changing application requirements. Can be adjusted in the range 0.901...1.0999.	
Power Line Frequency [Freq HZ]	60 Hz 	Provides measuring immunity to industrial noise from a power supply feed. It is factory set to 60 Hz, which is the value used in the US.
	50 Hz	Optional setting. 50 Hz is the value used outside the US.
Period [Period s] 	This parameter configures the frequency to 0...63 seconds of sampled measurements. The adjustment can be done in steps of 1 second. The value 0 is only used for calibration (4 measurements per second). NOTE: Parameters indicated by the battery icon affect battery performance. Standard sampling period is 15 seconds.	
Empty Pipe Detection	Empty Pipe ON/OFF [On Off] 	When set to ON, an Empty Pipe condition indicates to the outputs that the meter is not completely filled. When set to OFF, empty pipe conditions are not detected.
	Threshold [Threshold] 	Factory set and adjusted to the conductivity of normal water.
	Measure [Measure] Read only	Measures the real empty pipe value, Read Only.





Measure Menu

Measure																																									
<p>Flow Unit [Flow Unit]</p> 	<p>Establishes the unit of measure for the flow rate and full scale flow. Changing this parameter readjusts the full scale flow parameter. For example, changing from GPM to GPS would change the full scale flow from 60 gal/min to 1 gal/s.</p> <table border="1" style="width: 100%; border-collapse: collapse;"> <thead> <tr> <th style="text-align: center;"><i>Display</i></th> <th style="text-align: center;"><i>Flow Unit</i></th> <th style="text-align: center;"><i>Display</i></th> <th style="text-align: center;"><i>Flow Unit</i></th> </tr> </thead> <tbody> <tr> <td>L/S</td> <td>Liters/Sec</td> <td>GAL/S</td> <td>Gallons/Sec</td> </tr> <tr> <td>L/Min</td> <td>Liters/Min</td> <td>GAL/Min</td> <td>Gallons/Min</td> </tr> <tr> <td>L/h</td> <td>Liters/Hour</td> <td>GAL/H</td> <td>Gallons/Hour</td> </tr> <tr> <td>M3/S</td> <td>Cubic Meters/Sec</td> <td>MG/D</td> <td>MillionGallons/Day</td> </tr> <tr> <td>M3/Min</td> <td>Cubic Meters/Min</td> <td>IG/S</td> <td>ImperialGallons/Sec</td> </tr> <tr> <td>M3/H</td> <td>Cubic Meters/Hour</td> <td>IG/Min</td> <td>ImperialGallons/Min</td> </tr> <tr> <td>Ft3/S</td> <td>Cubic Feet/Sec</td> <td>IG/H</td> <td>ImperialGallons/Hour</td> </tr> <tr> <td>Ft3/Min</td> <td>Cubic Feet/Min</td> <td>bbl/Min</td> <td>Barrel/Min</td> </tr> <tr> <td>Ft3/H</td> <td>Cubic Feet/Hour</td> <td>OZ/Min</td> <td>Ounces/Min</td> </tr> </tbody> </table>	<i>Display</i>	<i>Flow Unit</i>	<i>Display</i>	<i>Flow Unit</i>	L/S	Liters/Sec	GAL/S	Gallons/Sec	L/Min	Liters/Min	GAL/Min	Gallons/Min	L/h	Liters/Hour	GAL/H	Gallons/Hour	M3/S	Cubic Meters/Sec	MG/D	MillionGallons/Day	M3/Min	Cubic Meters/Min	IG/S	ImperialGallons/Sec	M3/H	Cubic Meters/Hour	IG/Min	ImperialGallons/Min	Ft3/S	Cubic Feet/Sec	IG/H	ImperialGallons/Hour	Ft3/Min	Cubic Feet/Min	bbl/Min	Barrel/Min	Ft3/H	Cubic Feet/Hour	OZ/Min	Ounces/Min
<i>Display</i>	<i>Flow Unit</i>	<i>Display</i>	<i>Flow Unit</i>																																						
L/S	Liters/Sec	GAL/S	Gallons/Sec																																						
L/Min	Liters/Min	GAL/Min	Gallons/Min																																						
L/h	Liters/Hour	GAL/H	Gallons/Hour																																						
M3/S	Cubic Meters/Sec	MG/D	MillionGallons/Day																																						
M3/Min	Cubic Meters/Min	IG/S	ImperialGallons/Sec																																						
M3/H	Cubic Meters/Hour	IG/Min	ImperialGallons/Min																																						
Ft3/S	Cubic Feet/Sec	IG/H	ImperialGallons/Hour																																						
Ft3/Min	Cubic Feet/Min	bbl/Min	Barrel/Min																																						
Ft3/H	Cubic Feet/Hour	OZ/Min	Ounces/Min																																						
<p>Totalizer Unit [Tot Unit]</p> 	<p>Establishes the units of measure for the totalizers.</p> <table border="1" style="width: 100%; border-collapse: collapse;"> <thead> <tr> <th style="text-align: center;"><i>Display</i></th> <th style="text-align: center;"><i>Totalizer Unit</i></th> </tr> </thead> <tbody> <tr> <td>L</td> <td>Liters</td> </tr> <tr> <td>HL</td> <td>Hectoliter</td> </tr> <tr> <td>M3</td> <td>Cubic Meters</td> </tr> <tr> <td>Ft3</td> <td>Cubic Feet</td> </tr> <tr> <td>GAL</td> <td>US Gallons</td> </tr> <tr> <td>MG</td> <td>Million Gallons</td> </tr> <tr> <td>IG</td> <td>Imperial Gallons</td> </tr> <tr> <td>bbl</td> <td>Barrels</td> </tr> <tr> <td>OZ</td> <td>Ounces</td> </tr> <tr> <td>AFt</td> <td>Acre-Feet</td> </tr> <tr> <td>SFd</td> <td>Second-Foot-Day</td> </tr> <tr> <td>KG</td> <td>Kilograms</td> </tr> </tbody> </table>	<i>Display</i>	<i>Totalizer Unit</i>	L	Liters	HL	Hectoliter	M3	Cubic Meters	Ft3	Cubic Feet	GAL	US Gallons	MG	Million Gallons	IG	Imperial Gallons	bbl	Barrels	OZ	Ounces	AFt	Acre-Feet	SFd	Second-Foot-Day	KG	Kilograms														
<i>Display</i>	<i>Totalizer Unit</i>																																								
L	Liters																																								
HL	Hectoliter																																								
M3	Cubic Meters																																								
Ft3	Cubic Feet																																								
GAL	US Gallons																																								
MG	Million Gallons																																								
IG	Imperial Gallons																																								
bbl	Barrels																																								
OZ	Ounces																																								
AFt	Acre-Feet																																								
SFd	Second-Foot-Day																																								
KG	Kilograms																																								
<p>Full Scale Flow [Full Sca]</p> 	<p>Sets the maximum flow the system is expected to measure. Influences other system parameters, including:</p> <ul style="list-style-type: none"> • Low Flow Cutoff – Changes to full scale flow affect the measuring cut-off threshold of the meter • Alarm Outputs – Changes to full scale flow adjusts the thresholds for generating setpoint alarms • Pulse Outputs – Changes to full scale flow adjusts the pulse frequency and duty cycle <p>Change the full scale flow based on the meter size and the application’s requirements. Verify that the full scale flow falls within the meter’s suggested flow range limits. Flow Range: 0.1...32.8 ft/s (0.03...10 m/s) The full scale flow is valid for both flow directions.</p> <p>NOTE: If the flow rate exceeds the full scale setting by more than 25%, a FLOW_OVERLOAD_WARNING message indicates that the configured full scale range has been exceeded. The meter continues to measure. This affects the latency of the pulse outputs and may cause overflow.</p>																																								
<p>Low Flow Cutoff [Cut Off]</p> 	<p>Defines the threshold at which flow measurement is forced to zero. The cutoff value can be set from 0...9.9% of the full scale flow. Increasing this threshold helps prevent false readings during “no flow” conditions possibly caused by pipe vibration or inherent system noise.</p>																																								





Measure	
Flow Direction [Bi-directional] 	Allows setting the meter to measure forward flow only (unidirectional) or both forward and reverse flow (bidirectional). Unidirectional Flow is totalized in only one direction. The flow direction is indicated by the arrow printed on the detector label. Unidirectional measurements on the main display screen include: T1: Registers forward flow, resettable by menu or Modbus RTU. T2: Registers forward flow, non-resettable. Bidirectional Flow is totalized in both directions. A change of flow direction can be indicated by the digital output. Bidirectional measurements on the main display screen include: T1+: Registers forward flow, resettable by menu or Modbus RTU T1-: Registers reverse flow, resettable by menu or Modbus RTU T1N: Registers total flow, T+ - T-, resettable by menu or Modbus RTU T2+: Registers forward flow, non-resettable T2-: Registers reverse flow, non-resettable T2N: Registers total flow, T+ - T-, non-resettable
T1 Reset [T1] 	Allows the reset of totalizer T1. NOTE: If the meter is used as a water meter according the European directive 2004/22/EC (MID MI-001) or OIML R49, then the totalizer T1 is non-resettable.
Median [Median]	Can be set to ON or OFF. When set to ON, the median display filters out the flow rate fluctuations displayed on the LCD.
Average [Average]	Known as a moving average filter. The user can select how many flow rate measurements to be averaged together to calculate the current flow rate value. Dampens the rate of change of the flow rate. Moving average filter (MAV) smooth out short-term fluctuations. The value can be adjusted from 1 to 99 measuring periods. Using a setting of 1 will effectively disable the moving average filter. The delay is calculated: Delay [s] = MAV x T The time T is given by the adjusted excitation frequency (period) of the meter. For example MAV = 2 and the excitation frequency (period) is T = 5 s means a delay of 10 s.
A Factor [A FActor]	This setting is used to configure the acceleration factor for an advanced moving average filter. See "Advanced Moving Average Flow Filtering" on page 41 .
Filter Display [FiltDisp]	Can be set from 0...99 seconds. The display updates less frequently, depending on how high the filter display is set.

Inputs/Outputs Menu



Inputs/Outputs							
Flow Simulation [Simulat] 	Provides output simulation based on a percentage of the full scale flow. Simulation does not accumulate the totalizers. The range of simulation includes –100...100% of the full scale flow. The parameter lets you set the range of simulation in increments of 50 (OFF, 0, 50, 100, –50, –100). The factory default is OFF.						
Digital Input [Input] 	<ul style="list-style-type: none"> • Allows you to reset the T1 totalizer or interrupt flow measurement. Only the T1 can be reset. • Input switching is provided by applying an external voltage of 3...35V DC. • Use a “normally open” contact for operating. 						
Digital Outputs [Outputs] <i>(continued on next page)</i>	<table border="1" style="width: 100%; border-collapse: collapse;"> <tr> <td style="width: 15%; vertical-align: top;"> Pulse/Unit  </td> <td> Allows you to set how many pulses per unit of measure to transmit to remote applications. For example, assuming the unit of measure is gallons: <ul style="list-style-type: none"> • Setting the Pulses/Unit to 1 (standard setting) transmits 1 pulse every gallon • Setting the Pulses/Unit to 0.01 transmits 1 pulse every 100 gallons You must configure Pulses/Unit if the function of the selected output is to be forward or reverse . The parameter must be considered with the Pulse Width and Full Scale Flow parameters. The maximum pulse frequency is 100 Hz. The frequency is correlated with the flow rate. Violation of output frequency limits generates a PULSE_OVERLOAD_WARNING. </td> </tr> <tr> <td style="vertical-align: top;"> Width  </td> <td> Establishes the ON duration of the transmitted pulse. The configurable range is 0...500 ms. The factory default is 0 ms. <ul style="list-style-type: none"> • Non-zero pulse width configuration – the OFF duration of the transmitted pulse is dependent on flow rate. The OFF duration is to be at least the configured ON duration. At full scale flow, the ON duration equals the Off duration. The maximum configurable output frequency is limited to 100 Hz. • The duty cycle of the transmitted pulse is at 50% of the output frequencies greater than 1 Hz. The parameter must be considered with the Pulses/Unit and Full Scale Flow parameters. The maximum pulse frequency is 100 Hz. The frequency is correlated with the flow rate. Violation of output frequency limits generates a PULSE_OVERLOAD_WARNING. </td> </tr> <tr> <td style="vertical-align: top;"> Frequency [Hz]  </td> <td> Calculated pulse frequency (in Hz) corresponding to full scale flow. </td> </tr> </table>	Pulse/Unit 	Allows you to set how many pulses per unit of measure to transmit to remote applications. For example, assuming the unit of measure is gallons: <ul style="list-style-type: none"> • Setting the Pulses/Unit to 1 (standard setting) transmits 1 pulse every gallon • Setting the Pulses/Unit to 0.01 transmits 1 pulse every 100 gallons You must configure Pulses/Unit if the function of the selected output is to be forward or reverse . The parameter must be considered with the Pulse Width and Full Scale Flow parameters. The maximum pulse frequency is 100 Hz. The frequency is correlated with the flow rate. Violation of output frequency limits generates a PULSE_OVERLOAD_WARNING.	Width 	Establishes the ON duration of the transmitted pulse. The configurable range is 0...500 ms. The factory default is 0 ms. <ul style="list-style-type: none"> • Non-zero pulse width configuration – the OFF duration of the transmitted pulse is dependent on flow rate. The OFF duration is to be at least the configured ON duration. At full scale flow, the ON duration equals the Off duration. The maximum configurable output frequency is limited to 100 Hz. • The duty cycle of the transmitted pulse is at 50% of the output frequencies greater than 1 Hz. The parameter must be considered with the Pulses/Unit and Full Scale Flow parameters. The maximum pulse frequency is 100 Hz. The frequency is correlated with the flow rate. Violation of output frequency limits generates a PULSE_OVERLOAD_WARNING.	Frequency [Hz] 	Calculated pulse frequency (in Hz) corresponding to full scale flow.
Pulse/Unit 	Allows you to set how many pulses per unit of measure to transmit to remote applications. For example, assuming the unit of measure is gallons: <ul style="list-style-type: none"> • Setting the Pulses/Unit to 1 (standard setting) transmits 1 pulse every gallon • Setting the Pulses/Unit to 0.01 transmits 1 pulse every 100 gallons You must configure Pulses/Unit if the function of the selected output is to be forward or reverse . The parameter must be considered with the Pulse Width and Full Scale Flow parameters. The maximum pulse frequency is 100 Hz. The frequency is correlated with the flow rate. Violation of output frequency limits generates a PULSE_OVERLOAD_WARNING.						
Width 	Establishes the ON duration of the transmitted pulse. The configurable range is 0...500 ms. The factory default is 0 ms. <ul style="list-style-type: none"> • Non-zero pulse width configuration – the OFF duration of the transmitted pulse is dependent on flow rate. The OFF duration is to be at least the configured ON duration. At full scale flow, the ON duration equals the Off duration. The maximum configurable output frequency is limited to 100 Hz. • The duty cycle of the transmitted pulse is at 50% of the output frequencies greater than 1 Hz. The parameter must be considered with the Pulses/Unit and Full Scale Flow parameters. The maximum pulse frequency is 100 Hz. The frequency is correlated with the flow rate. Violation of output frequency limits generates a PULSE_OVERLOAD_WARNING.						
Frequency [Hz] 	Calculated pulse frequency (in Hz) corresponding to full scale flow.						

Inputs/Outputs																																																														
Digital Outputs <i>(continued)</i>	Set Minimum [Set Min] 	Establishes, as a percentage of full scale flow, the threshold at which the output alarm is activated. Flow rates below the threshold activate the output alarm.																																																												
	Set Maximum [Set Max] 	Establishes, as a percentage of full scale flow, the threshold at which the output alarm is activated. Flow rates above the threshold activate the output alarm.																																																												
	Function [Out 1 Func] [Out 2 Func] [Out 3 Func] [Out 4 Func] 	Provides configuration of the functional operation of the associated output. The following operations are supported: <table border="1" style="width: 100%; border-collapse: collapse; text-align: center;"> <thead> <tr> <th>Function</th> <th>Dig1</th> <th>Dig2</th> <th>Dig3</th> <th>Dig4</th> </tr> </thead> <tbody> <tr> <td>Off</td> <td>X</td> <td>X</td> <td>X</td> <td>X</td> </tr> <tr> <td>Test</td> <td>X</td> <td>X</td> <td>X</td> <td>X</td> </tr> <tr> <td>MinMax</td> <td>X</td> <td>X</td> <td>X</td> <td>X</td> </tr> <tr> <td>Empty</td> <td>X</td> <td>X</td> <td>X</td> <td>X</td> </tr> <tr> <td>ErAlarm</td> <td>X</td> <td>X</td> <td>X</td> <td>X</td> </tr> <tr> <td>Forward</td> <td>X</td> <td></td> <td></td> <td></td> </tr> <tr> <td>Loopback</td> <td>X</td> <td>X</td> <td>X</td> <td>X</td> </tr> <tr> <td>Battery Alarm</td> <td>X</td> <td>X</td> <td>X</td> <td>X</td> </tr> <tr> <td>Reverse</td> <td></td> <td>X</td> <td></td> <td></td> </tr> <tr> <td>Direct</td> <td></td> <td></td> <td>X</td> <td></td> </tr> <tr> <td>ADE</td> <td></td> <td></td> <td></td> <td>(set automatically)</td> </tr> </tbody> </table> <ul style="list-style-type: none"> Inactive [Off] means digital output is switched off. It is recommended to switch off the outputs in the menu "Output function" if not used. This increases the battery life time. Test [Test] triggers the output. Flow setpoint [MinMax] provides indication when flow rate exceeds thresholds defined by flow setpoints (set min, set max). Empty pipe alarm [Empty] provides indication when pipe is empty. Error alarm [ErAlarm] provides indication when meter has error condition. Forward pulse [Forward] generates pulses during forward flow conditions. Reverse pulse [Reverse] generates pulses during reverse flow conditions. Flow direction [Direct] provides indication on current flow direction. Loopback provides the same logic state at the output that is present at the digital input. Battery Alarm output gets triggered when a low battery is detected. ADE [ADE] "Absolute Digital Encoder" for remote meter reading using ASCII communication protocol . This setting is applied automatically if the communication mode is set to ADE. 	Function	Dig1	Dig2	Dig3	Dig4	Off	X	X	X	X	Test	X	X	X	X	MinMax	X	X	X	X	Empty	X	X	X	X	ErAlarm	X	X	X	X	Forward	X				Loopback	X	X	X	X	Battery Alarm	X	X	X	X	Reverse		X			Direct			X		ADE				(set automatically)
	Function	Dig1	Dig2	Dig3	Dig4																																																									
Off	X	X	X	X																																																										
Test	X	X	X	X																																																										
MinMax	X	X	X	X																																																										
Empty	X	X	X	X																																																										
ErAlarm	X	X	X	X																																																										
Forward	X																																																													
Loopback	X	X	X	X																																																										
Battery Alarm	X	X	X	X																																																										
Reverse		X																																																												
Direct			X																																																											
ADE				(set automatically)																																																										
Output Mode [Out 1 Type] [Out 2 Type] [Out 3 Type] [Out 4 Type] 	Allows you to set the output switch to normally open or normally closed. If normally open is selected, the output switch is open (no current) when the output is inactive, and closed (current flows) when the output is active. If normally closed is selected, the output switch is closed (current flows) when the output is inactive, and open (no current) when the output is active.																																																													







Communication Menu

Communication: Port Settings		
Interface [Interface] 	Provides communication port configuration. <ul style="list-style-type: none"> • IrDA (Modbus RTU) • Serial (Modbus RTU) NOTE: Modbus RTU is only for programming the meter or reading the internal data logger. Extended use, even in standby mode, uses power and can drain the battery quickly. <ul style="list-style-type: none"> • M-Bus • OFF (turns off the serial interfaces). Serial interfaces left ON shorten the battery life. 	
Serial [Serial]	Baud Rate [Baudrate] 	Sets the baud rate. The following baud rates are supported: <ul style="list-style-type: none"> • 9600 (Default) • 1200 • 2400
	Parity [Parity] 	Sets the parity. The following parities are supported: <ul style="list-style-type: none"> • Even (Default) • Odd • Mark
Modbus [Modbus]	Address 	Configures the Modbus address in the range of 1...247. See the "M-5000 Modbus Communication Protocol Memory Map" application data sheet (available at www.badgermeter.com) for Modbus register information.
M-Bus [M-Bus]	Address 	Configures the M-Bus® address in the range of 1...247. (Only available on the M-Bus version M5000.)
ADE	Control	ON/OFF
	Protocol [Protocol]	V1 standard messages V2 extended messages
	Dial [Dial]	4...9
	Resolution [Resolution]	0.0001...10000

Battery Menu

PwrUpCnt (Read Only)	(Power Up Counter) A diagnostic counter of how many times the meter has reset or been power cycled (for instance, battery removed and replaced).	
Voltage (Read Only)	Displays the current battery voltage.	
Lifetime (Read Only)	Displays the remaining battery life time in years depending on the currently selected parameters. NOTE: Battery life time is mainly influenced by the excitation frequency (period) and selected communication interfaces.	
OnTime (Read Only)	Diagnostic that refers to the amount of time the meter has been powered in terms of hours.	
Amp-Hours [Ah] (Read Only)	Displays the battery output capacity in terms of Ah consumed divided by Ah total capacity.	
Capacity [CAPAcitY] (Read Only)	Displays the current battery capacity in Amp hours or Percent. NOTE: A new battery should be at or near maximum capacity.	
Limit 	Options: 5, 10, 15, 20, 25, 30, OFF	Sets the battery capacity remaining threshold that generates an output alarm when the remaining battery capacity drops below the threshold. Set to <i>OFF</i> if output alarm is not needed.
Change 	Options: 19, 38, 70, Ah	Allows the user to change the battery through a controlled process. The user selects the new battery pack capacity and then is required to replace the battery. While in entry mode, exit from this menu item is prohibited until after the battery is replaced. Additionally, this is the required process to save necessary measurement data to non-volatile memory while also resetting all battery configuration and diagnostic data (such as lifetime, capacity remaining, saved totalizers).

Miscellaneous Menu

Misc	
Settling [Read Only]	The time the magnetic circuit takes to settle. An engineering diagnostic.
Language [Language]	Allows you to change the current language. English is the default setting. The following languages are supported: German (Deutsch), Czech (Cestina), Spanish (Espanol), French (Francais), Russian (России), Italian (Italiano)), Turkish (Turk), and Polish (PolSKI).
 U	
Date [Date DMY] [Read Only]	Real-time calendar. The day, month and year must be reprogrammed after the battery is replaced or powered off.
 S	
Time [Time]	Real-time clock. The hour, minute and second must be reprogrammed after the battery is replaced or powered off.
 S	
EEPROM [EEPROM]	Format the EEPROM to erase all log files. Totalizers and configuration remain unaffected during a format.
 A	
Battery [Battery]	Saves Totalizers to nonvolatile memory in preparation for battery replacement.
 S	
Restart [Restart]	Provides the ability to reset the meter electronics.
 S	
HDD Free [HDD Free] (Read only)	Indicates the amount of free flash memory space.
 S	
Polarity [Polar V] (Read only)	Measured electrode polarizing voltage (for service purposes).
Datalogger [DataLog]	The logging period can be adjusted to the following values: 1 min / 15 min / 1 h / 6 h / 12 h / 24 h. See the <i>Datalogging User Manual</i> for more information.
LCD Contrast [ContrASt]	Sets the LCD contrast in the range 0...9, with 9 being highest contrast setting. Contrast does not immediately change upon modifying this digit. Press SAVE to change the contrast. Note that higher contrast setting may affect the battery life of the product.
LCD Test [LCD Test]	After pressing E , all display segments appear for about 2 seconds.

Information Menu

Info	
Serial Number [SerNum] (Read Only)	Serial number of the electronic board.
Software Version [Version] (Read Only)	Software version of the device.
Compilation Date [Compilat] (Read Only)	Date of the software version.
OPT CRC [OPT CRC] (Read Only)	Checksum of the software update.
APP CRC [APP CRC] (Read Only)	Checksum of the application.
OIML Mode [OIML mode] (Read Only)	If the meter is used as a water meter according to OIML R49 or MID, the mode has to be ON. In this case, all parameters are "read only".

Faults Menu

Faults	
Preamp	The Faults menu displays the errors and the number of times they have occurred each hour. For an explanation of the error or how to fix it, see "Errors and Warnings" on page 47 .
Coil	
Empty Pipe	
Measure Time	
Volume Overflow	

SECURITY

The M5000 security feature allows the option to restrict access to the meter by way of a 6-digit Personal Identification Number (PIN). The default password is 000000 if no other password is entered. Not all levels of access need to be set. If no PINs are set, any M5000 user has access to all functions but cannot change parameters.

NOTE: If the meter is used as a water meter according to the European directive 2004/22/EC (MID MI-001) or OIML R49, all parameters are locked and only readable. In this case, the password feature is not feasible.

IMPORTANT

A new M5000 meter comes from the factory with the Security feature jumper on the underside of the electronics board in the *INACTIVE* position (with the jumper shorting the center and right pins). After you set a PIN, move the jumper to the *ACTIVE* position (with the jumper shorting the center and left pins) so you can use the Security functions. See the illustrations under "[Activating the Security Feature](#)" below. If you set a PIN for the Administration mode and then later decide you also need to set a User or Service pin, first move the jumper back to the *INACTIVE* position, then set another pin, then move it back to the *ACTIVE* position.

The system administrator can set up a single PIN for each of the three different levels of access:

- **Administration** – allows access to all M5000 menu configuration screens.
- **Service** – allows access to service-level and user-level menu configuration screens.
- **User** – allows access only to user-level menu configuration screens.

NOTE: For a lost PIN, contact Badger Meter Technical Support at 800-456-5023.

The security settings also apply to remote access. All remote writes via Modbus to the meter are blocked unless the user is remotely logged in.

Setting a PIN

1. From the *Main Menu*, press the **right-arrow** button.
2. From the *Meter Setup* menu, press the **up-arrow** button until the *Pin* menu is displayed.
3. Press the **right-arrow** button to display the *PINS Control* menu.
4. Press the **right-arrow** button to flash ON or OFF.
5. With either ON or OFF flashing, press the **up-arrow** button to display ON.
6. Press the **EXIT SAVE** button to save the ON setting.
7. With the *Control* menu flashing, press the **up-arrow** button to display the desired security level (user, service, or admin).
8. With the desired security level flashing, press the **right-arrow** button to display the upper row of six zeros (digits).
9. Press the **up-arrow** button to change the first digit, followed by pressing the **right-arrow** button to select the next digit.
10. Press the **EXIT SAVE** button to save the PIN number for that security level.

Activating the Security Feature

1. Unscrew and open the enclosure cover.
2. Unscrew and remove the 4 screws holding the circuit board.
3. Flip the circuit board so the back side faces up.
4. Locate the jumper at the bottom center of the board.
5. Move the jumper from the *INACTIVE* position (shorting the center and right pins) to the *ACTIVE* position (shorting the center and left pins).
6. Flip the circuit board so it faces up.
7. Secure the circuit board with 4 screws.
8. Close the enclosure cover and tighten the 4 screws.

The saved PIN number is the same PIN number used to log in to the amplifier.

NOTE: Be sure to log off when you have completed work with the M5000. Otherwise, a five-minute time delay occurs between the most recent activity and the time when the M5000 automatically logs off.

**INACTIVE
Position**



**ACTIVE
Position**

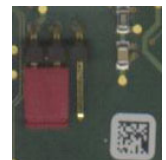

Logging In





To change any parameter in the mag meter, the PIN entered must provide the proper security privilege required by the parameter.

To enter a PIN, go to the *Login* menu and enter the PIN for the required security level. Once you are properly logged in, the unlocked icon appears on the meter display. A **PIN Error** message displays if the incorrect PIN is entered.

Logging Out

To log out, follow steps 1 through 8 under "*Setting a PIN*". At step 9, enter an invalid PIN, then press **EXIT SAVE**.

PIN Menu

PIN	
Control 	Two options are available: <ul style="list-style-type: none"> • ON (requires PIN configuration) • OFF
User 	Users logged in with this PIN have access to all user levels. Users at this level do not have access to Service or Admin functions.
Service 	Users logged in with this PIN have access to both service and user-level procedures. Users at this level do not have access to Admin functions.
Admin 	Users logged in with this PIN have access to all procedures. Users at this level have full access to the meter.
Random	Generates a random number which is used when a PIN is lost. This number is needed for Badger Meter Tech Support to provide a Master PIN.
Emergency	Enter the Master PIN received from Badger Meter Technical Support to unlock the meter in case the Admin PIN has been lost.

ADVANCED MOVING AVERAGE FLOW FILTERING

Introduction

This section is focused on the description of the advanced moving average filter used on the M5000 Mag Meter. This section provides instructions on how the advanced moving average filter works to smooth out fluctuations in flow velocity measured by the M5000 and explains how to configure the filter's settings to be used for specific applications.

Definition

The standard moving average filter that is applied by the firmware of the M5000 can be user-activated by setting a value higher than 1 in menu item *Average* option in the *Measure* menu. To access this setting, navigate to *Main Menu > Measure > Average*.

This value defines how many measured flow rate samples are averaged together to calculate the current flow rate value. This value is defined also as a damping factor or average window length. Averaging/filtering is recommended for noisy measurement applications (for example, dirty or low conductivity water or slurry flow measurement) where inconsistencies within the process fluid contribute to instability of measured flow. Using a moving average filter, the flow rate fluctuations caused by the inconsistencies of the fluid can be smoothed out. On the other hand, the moving average has the disadvantage of slow reaction on true flow changes. This limits usage of the standard moving average filtering in many applications, typically in regulation systems.

The advanced moving average filter provides more rapid reaction on true flow changes. This detection system uses only moving average window length and a flow acceleration factor which gives an accumulator maximum value. The M5000 user can configure the acceleration factor through the *A Factor* option in the *Measure* menu. To access this setting, navigate to *Main Menu > Measure > A Factor*.

Acceleration is detected by accumulation of an acceleration ratio (acceleration band). Each acceleration band (or bandwidth) is exactly 2* low flow cut-off wide. When the raw flow rate is in this state of acceleration, the advanced moving average filter will use an exponential curve to adjust the filtered flow rate value, thus responding much more rapidly than a standard moving average filter.

Acceleration ratio is calculated by how many acceleration bandwidth(s) the raw flow rate is away from the acceleration reference flow rate. The acceleration reference flow rate is typically the last averaged flow rate value. It is important to note that the acceleration reference flow rate may be at a different value than the actual flow rate displayed to the M5000 display. This is because the reference only changes when either the acceleration ratio accumulation exceeds the flow acceleration value given by the acceleration factor (*A Factor*) value, or when the raw flow rate is less than one full bandwidth away from the reference flow rate (flow ratio = 0). The latter happening when there is nearly stable flow rate measured. Once either of these scenarios takes place the acceleration reference value is re-calculated to use the last, averaged flow rate.

Finally, when the acceleration ratio accumulation exceeds the acceleration factor value, this signifies to the algorithm a "real" change in flow has occurred. At this point a new average window is established with respect to the raw flow rate measured.

Explanation

To further explain the functionality of the advanced moving average filter, see [Figure 36](#). The legend for the graph is as follows:

- Green curve gives the standard moving average filtered flow rate.
- Magenta/pink curve gives the advanced moving average filtered flow rate.
- Black line gives the raw flow rate measured.
- Light blue line is the acceleration reference flow rate.
- Red dotted lines define the acceleration bands in the positive flow change direction.
- Blue dotted lines define the acceleration bands in the negative flow change direction.
- Brown vertical lines give the acceleration ratio for each sample, or how many bands are passed going from the reference to the raw flow rate.

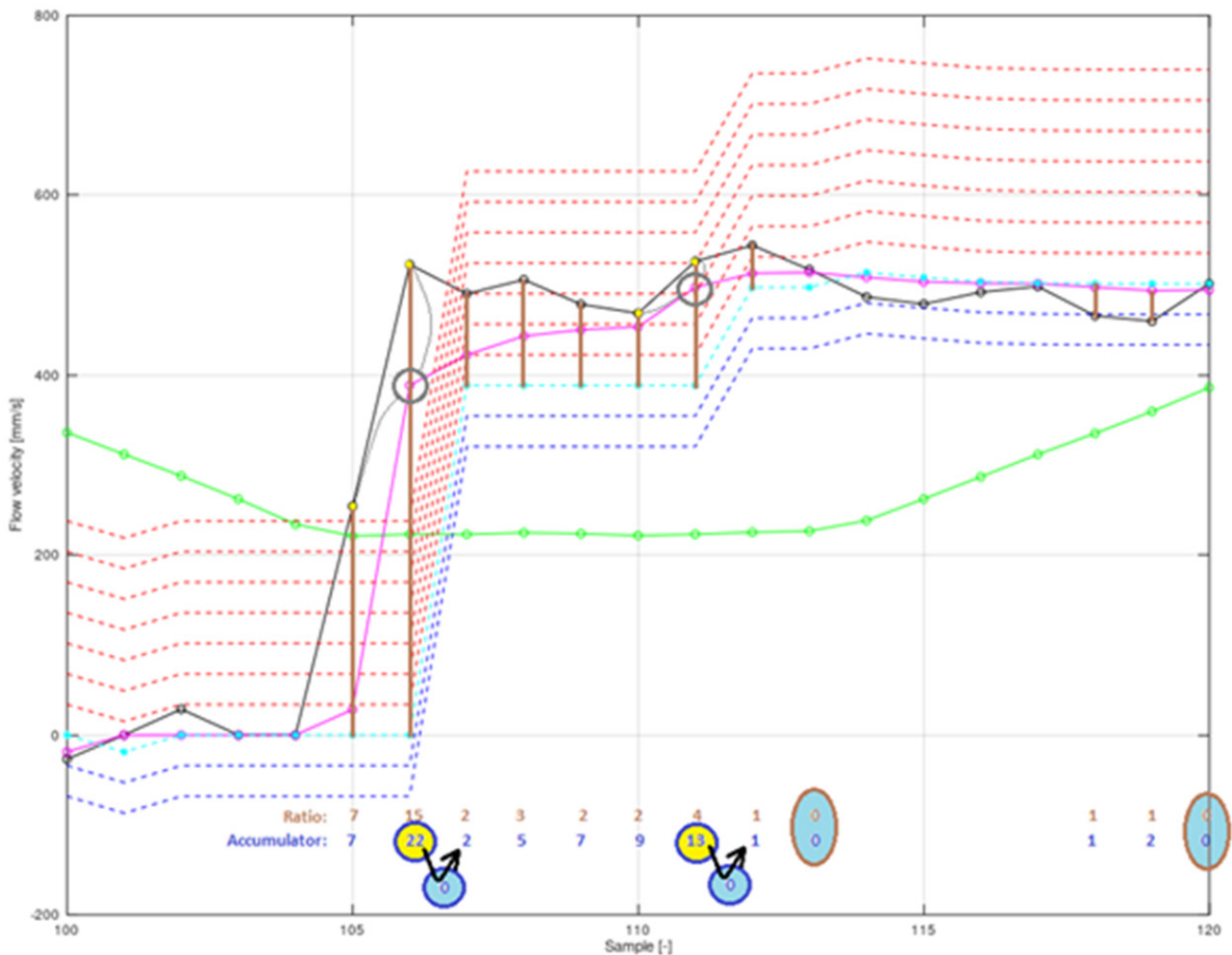

Figure 36: Graph of flow velocity processing and filtering during transition from zero to 500 mm/s

In [Figure 36](#), the standard moving average and advanced moving average filtering is demonstrated during a transition of true flow from standing water state (pump off, zero flow) to constant flow about 500 mm/s (pump on). Sampling rate was set to 15 s (recommended battery mode) and flow sensor used was DN50. The black curve shows raw measured flow velocity without filtering, the green curve corresponds to filtration by the standard moving averaging (MA) with window length 10. The magenta curve shows application of the advanced moving average filter (AMA) with moving average length 10, and acceleration factor of 10. The graph demonstrates stabilization of measured and filtered flow by the AMA. The standard MA is not suitable for such application, the transition settling is too long. The AMA settling is relatively short, about two samples, if error window length is small.

Looking to specifics of the graph, at sample 105 is when the pump turned on and the raw flow rate has started to change. Notice at sample 105 the raw flow rate (black) is 7 acceleration bands away from the acceleration reference (light blue). This is drawn for clarity by the brown vertical line. These seven bands are added to the accumulator value. Also, it should be noticed that since the raw flow rate is in a state of acceleration, the AMA flow rate calculated (pink line) has already started to respond by changing on an exponential curve.

At sample 106 the raw flow rate has risen more (higher acceleration). The difference between raw flow and reference is now 15 acceleration bands. These 15 get added to the accumulator. The accumulator has now exceeded the acceleration factor setting of 10, and a new reference must be calculated for the AMA filter. The benefit of the advanced moving average filter can clearly be seen at sample 106 and the following 10 – 15 samples. The pink, AMA, curve is tracking much more closely to the raw (real) flow velocity than the standard MA (green) curve is. The green curve must wait for the average window to populate with 10 samples before it begins to respond to the change in raw flow. With a sample rate of 15 seconds this means at least 150 seconds have passed before the change in real flow is responded to by the standard moving average filter.

At sample 111 there is again an accumulation of acceleration ratio which exceeds the acceleration factor of 10. The reference assumes a new position on the following sample, sample 112. The new position it assumes is at the same flow velocity as, and lines up horizontally with, the previous filtered flow velocity (pink curve).

As flow stabilizes around sample 113 the raw flow rate is within the first acceleration band away from the reference. This is treated as steady flow and the ratio resets back to zero, along with the accumulator. When this happens, a new reference is calculated to ensure close tracking to the raw flow rate during times of steady flow.

Configuration of Average Length and Acceleration Factor

The advanced moving average filter can be effectively disabled by setting the Acceleration factor to 0. The moving average filter could still be used in this scenario. The maximum value for the acceleration factor is 99.

To disable all filtering with using a moving average, set the Average value to 1. This gives a window length of 1 to the moving average and will effectively disable all filtering. The maximum value for the average window length is 99.

For most applications, the ideal ranges for the AMA filter settings are as follows:

- Window Length (Average): 10 to 40
- Acceleration Factor (A_Factor): 5 to 15

For configuration of the advanced moving average settings (Average and A Factor), the following should be taken into consideration.

1. How quickly must the flow rate respond to a real change in flow?
 - a. If a quick response is desired, use a smaller acceleration factor of around 5 to 10, and use an average window length of about 10 to 20.
 - b. If responding quickly is not as important consider using a much larger average window length (40 or higher) and setting acceleration factor to 0, or something larger than recommended (20 or higher for example).
2. What is the measurement period configured? Is the measurement taken every 15 seconds (factory default) or is it faster or slower?
 - a. The lower the configured period is, the faster the moving average buffer will fill up.
 - b. If the measurement period is 15 seconds and the average is set to 10, then the buffer will fill up in 150 seconds.
 - c. However, if the sampling period is set to 2 seconds, and the average is set to 10 still, the buffer will fill up in 20 seconds instead. Filtered flow rate will be much more responsive to both noise and real flow measurements as the measurement period decreases. But that comes at the cost of reduced battery life for the product.
 - d. The measurement period will influence the usage of this AMA filter and the settings used to configure it.
3. What does the typical flow profile look like for the application? Is there constantly changing flow? By how much does the flow change? Does flow approach the low flow cutoff or zero flow? What is the pipe diameter used for the application?
 - a. If the flow rate is typically very stable and there are not large changes to the flow rate, the main purpose of the filter would be to smooth out the noise on the measurements. To do this consider using a small average window length (10 or less is possible). The acceleration factor could also be set low (5 to 10 ideally).
 - b. If the flow rate experiences large real flow fluctuations, it would be beneficial to take a larger average window length (20 to 30) and use a moderate level of acceleration factor (10 to 15).

- c. If the flow rate is very low, near low flow cutoff, then consider using a larger window average length (20 or more) and a low acceleration factor (2 to 10 for example).
- d. On larger pipes (DN300 and up, for example), there will be larger noise spikes. These spikes should be taken into consideration when selecting the average window length and a larger average could be used, a value of 40 to 50 could be suitable.
- e. The quality of fluid being measured also will influence the signal-to-noise ratio. Which in turn will lead to more frequent noise spikes in the raw flow rate readings. For poor fluid quality applications, or applications where there is media flowing through the pipe along with the fluid, consider using a larger acceleration factor, a value up to 20 could be suitable.

MAINTENANCE

Mandatory, routine or scheduled maintenance should not be required for the M5000 Electromagnetic Flow Meter electronics or flow tube after proper installation.

However, some occurrences may require personnel to perform the following:

- Flow tube and electrode cleaning
- Circuit board replacement

⚠ WARNING

DO NOT CLEAN COMPONENTS INSIDE THE AMPLIFIER OR JUNCTION BOX.

Cleaning the Flow Tube and Electrode

At times flow tube, electrodes, amplifier/junction box housings and the amplifier window may need cleaning, depending on process fluid properties, fluid flow rate and surrounding environment.

Clean the flow tube and electrodes by following the material handling and cleaning procedures documented in the Material Safety Data Sheet (MSDS) guidelines for the product(s) that were in contact with the flow tube and electrodes.

Should flow tube and/or electrode cleaning become necessary:

1. Disconnect detector from pipeline.
2. Clean electrodes according to MSDS guidelines.
3. Reconnect detector to pipeline.

Replacing Circuit Board

If the circuit board is damaged, follow these instructions to replace it.

1. Unplug the electrode and coil plugs.
2. Unscrew and remove screws S1-S4.

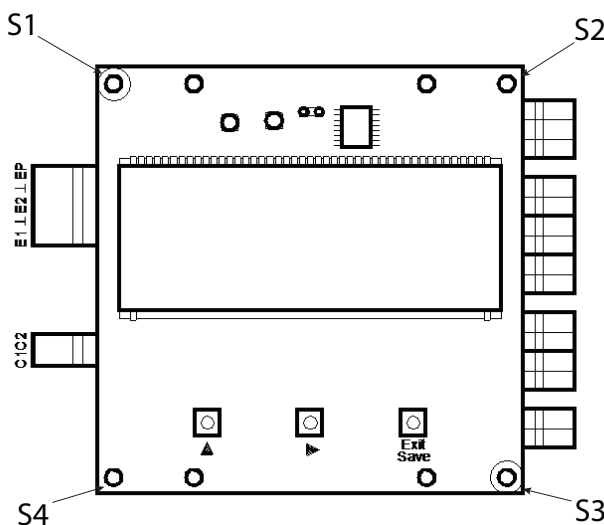

4. Remove the old circuit board.
5. Insert the new circuit board.
6. Secure it by fastening S1-S4 screws. Plug in the electrode and coil plugs.
7. If necessary, configure new circuit board related to the available meter (detector, size).

TROUBLESHOOTING

The M5000 mag meter is designed for many years of optimal performance. However, should it malfunction, there are certain things that we recommend you check before contacting our Technical Support department or your local Badger Meter Representative.

NOTE: If the fluid measured has a high concentration of conductive solids, deposits may accumulate on the internal liner walls and electrodes. These deposits cause a reduction of the measuring output. Thus, Badger Meter recommends that you remove the meter and inspect the liner and electrodes after six months. If deposits are found, remove them with a soft brush. Repeat inspection process every six months or until an appropriate inspection cycle can be established for the specific application.

Other general conditions include:

Description	Possible Cause	Recommended Action
Flow is present but display is "0"	Disconnected signal cable	Check signal cable
	Detector mounted opposite of the main flow direction (see arrow on the nameplate)	Turn detector 180° or switch terminal E1 and E2 or reprogram to bidirectional mode
	Coil or electrode cables exchanged	Check cable connections for cross wiring
	Improper low flow cutoff or full scale flow	Replace configuration defaults
Inaccurate measuring	Improper calibration	Check the parameters (detector factor and size) according to supplied data sheet
	Wrong calibration parameter	
	Pipe not fully filled, or air in pipe	Check if meter is completely filled with fluid
	Invalid fluid conductivity	Purge line to eliminate air bubbles
	Invalid fluid mixture	
	Missing or insufficient grounding	Verify grounding and fix any problems
Blank display	Dead battery	Replace battery
Flow rate value known to be wrong	Detector factor	Check value on label
	Deposits on electrodes and/or liner	Check and remove deposits
	Incorrect pipe size programmed	Check size if necessary
Flow rate indication unstable	Cable issue	Make sure cable is shielded and not vibrating
	Grounding issue	Make sure meter is properly grounded to a good earth ground
	Partially full pipe	Make sure pipe is full of fluid
	Air in pipe	Make sure fluid does not contain air bubbles
	Invalid fluid conductivity	Make sure amplifier is not too close to sources of electrical interference
BEACON displays multiple estimated flow occurrences for meters connected to ORION® Cellular LTE endpoints	ORION Cellular LTE endpoints require additional resistance	Add a 15K resistor to the M5000 terminal block. See "Adding Resistor with ORION Cellular LTE" on page 49

Errors and Warnings

What You See	Why It Happened	How to Fix It
[MeasTim] MEASURE_TIMEOUT	The board may be damaged.	Contact Badger Meter Technical Support.
[VolOver] COMMON_MODE_VOLTAGE_ OVERLOAD	Common mode voltage is smaller than -2.0V or larger than +4.1V.	Make sure the meter is properly grounded.
	Empty detector.	Switch Empty Pipe detection ON.
	Dirty electrodes.	Clean the electrodes.
[EmptyPi] EMPTY_PIPE_WARNING	Measured impedance between the Empty Pipe electrode and the Ground exceeded the set value.	<ul style="list-style-type: none"> Make sure the pipe is filled. Check Empty Pipe threshold. It should be 60000 Ω (corresponds with 20 μS/cm).
	Empty detector.	
[Output] PULSE_OVERLOAD_WARNING	Overflow occurred on the flow output.	Lower the pulse number.
[Range] FLOW_OVERLOAD_WARNING	Flow exceeded the Full Scale of more than 100%.	Set the flow range properly.
[LowPow] LOW_POWER_WARNING	Battery voltage is smaller than 3.0V.	Consider replacing the battery.
[EEPROM] EEPROM_ERROR	Configuration file is missing.	Replace the circuit board.
[Config] CONFIG_ERROR	Configuration file is corrupted.	Replace the circuit board.
[Preamp] PREAMPLIFIER_OVERLOAD	Input voltage exceeded the limits.	Maximum polarization is ± 227 mV; maximum power line noise is 10.6 mV; maximum useful signal is 10.7 mV.
	Empty detector.	Switch Empty Pipe detection ON.
	Dirty electrodes.	Clean the electrodes.
[Coil] COIL_ERROR	Coil/sensor is not connected.	<ul style="list-style-type: none"> Make sure wiring is properly connected to the amplifier. If that does not clear the alarm, contact Badger Meter Technical Support.
	Coil shorted.	
	Issue with coil current.	

When one of the errors occurs, the meter stops measuring until the error disappears; then the meter resumes measuring.

Repair of Faults

Disconnect all units from power supply and have it repaired by a qualified service person if any of the following occurs:

- Power cord or plug is damaged or frayed.
- Unit does not operate normally when operating instructions are followed.
- Unit is exposed to rain/water or liquid is spilled into it.
- Unit is dropped or damaged.
- Unit shows a change in performance, indicating a need for service.

CONNECTING AN ORION RTR® ENDPOINT TO THE M5000 METER

NOTE: Connect the endpoint as described. If there is a reading on the M5000, program the endpoint to match that reading or reset the totalizer. The endpoint requires programming per the endpoint user manual.

Wiring

To connect the RTR endpoint to Output #1 on the M5000, connect the red wire to the positive (+) terminal and the black and green wire to the negative (-) terminal.

To connect the RTR endpoint to Output #2 on the M5000, connect the red wire to the positive (+) terminal and the black and green wire to the negative (-) terminal.

Programming

To program the M5000 meter for the endpoint to Output #1 (forward flow):

1. Navigate to *IN/OUT > Simulat > Outputs > Puls/unit*.
2. Use the arrows to change the values, then press **EXIT/SAVE**.
3. Repeat steps 1 and 2 for *Width, Out 1 Func and Out 1 Type*.

NOTE: For Output #2 (forward flow), use *Out 2 Func* and *Out 2 Type* instead.

CONNECTING AN ORION ENCODER ENDPOINT TO THE M5000 METER

NOTE: Once connected, the endpoint automatically updates within one hour. You can force an update using the Endpoint Utility software. See the "ORION Endpoint Utility" user manual for programming information available at www.badgermeter.com.

Wiring

Connect the encoder endpoint to the meter:

Encoder Wire	M5000 Terminal
Red (Power/Clock)	Input +
Green (Data)	Out 4 +
Black (Ground)	Out 4 -

Connect a jumper wire from Out 4 negative (-) to INPUT negative (-).

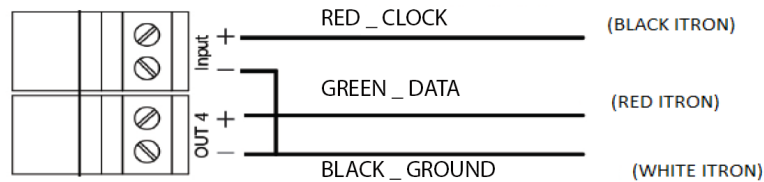

Figure 37: M5000 endpoint connection

Adding Resistor with ORION Cellular LTE

When connected to an ORION Cellular LTE endpoint, additional resistance is required. Add a 15K resistor to the M5000 terminal block between Input + (red wire) and Out 4 + (green wire) as shown. The resistor is represented in red in [Figure 38](#).



Figure 38: ORION Cellular LTE endpoint connection with resistor

Order resistor kit P/N 69224-001 from Badger Meter.

Programming

Changing the following settings automatically configures *Input* and *Output 4* for ADE.

To program the M5000 meter for the endpoint to Output #1 (forward flow):

1. Navigate to *COMMUNIC > INTERFAC > ADE > CONTROL*.
2. Use the arrows to change the values, then press **EXIT/SAVE**.
3. Repeat steps 1 and 2 for *Control, Protocol, Dials and Resolution* (the Resolution range is 0.0001...10,000).
4. Press **EXIT/SAVE**.

SPECIFICATIONS

NOTE: Measurements in DN are for Nominal Diameter in mm.

M5000 Amplifier

Flow Range	0.1...32.8 ft/s (0.03...10 m/s)
Accuracy	± 0.4% of measured value ± 2 mm/s OIML/MID: 2...24 in. (DN50...600) with 0d up and 0d downstream ±1% ≥ 1.2 ft/s (0.35 m/s)
Repeatability	± 0.1%
Ambient Temperature	-4...140° F (-20...60° C)
Flow Direction	Uni-directional or bi-directional. Two separate programmable totalizers for uni-directional measurement.
Digital Outputs (4)	Galvanically isolated open collector, 30V DC maximum, 20 mA each, maximum output frequency at 100 Hz Absolute Digital Encoded output for connectivity to AquaCUE or BEACON cellular endpoints
Status Outputs	ADE, High/low flow alarm (0...100% of flow), error alarm, empty pipe alarm, flow direction
Communication	RS232, Modbus RTU, IrDA, M-Bus, RS 485 (optional), External AMR or GSM/GPRS module (optional)
Empty Pipe Detection	Separate electrode, field-tunable for optimum performance based on specific application
Min-Max Flow Alarm	Programmable outputs 0...100% of flow
Low Flow Cut-Off	Programmable 0...10% of maximum flow
Galvanic Separation	Functional 500 volts
Pulse Width	Programmable 5...500 ms
Coil Power	Pulsed DC
Sampling Rate	Programmable from 1 to 63 seconds. Standard sampling period is 15 seconds.
Display	Two lines x 15 characters (7 on top + 8 on bottom), LCD display
Programming	Three external buttons
Units of Measure	Gallons, ounces, MGD, liters, cubic meters, cubic feet, imperial gallon, barrel, hectoliter and acre feet
Battery Life	<i>Standard:</i> 10 years with one battery pack; <i>optional:</i> up to 20 years with two battery packs for sizes 6 in. (DN 150) or smaller.
Power Supply	<i>Standard:</i> Internal lithium batteries 3.6 volt, optional external battery pack <i>Optional:</i> battery back-up model (100...240V AC or 9...36V DC)
Processing	Low power microcontroller (16 bit)
Amplifier Housing	NEMA 4X (IP67, optional IP68), cast aluminum, powder-coated paint
Mounting	Detector-mount or remote wall mount (bracket supplied)
Meter Enclosure Classification	<i>Standard:</i> NEMA 4X (IP67); <i>Optional:</i> Submersible NEMA 6P IP68, remote amplifier required
Junction Box Enclosure Protection	For remote amplifier option: Powder coated die-cast aluminum, NEMA 4 (IP67)
Approvals	NSF/ANSI/CAN 61 and 372 Listed Models with hard rubber liner 4 in. (DN 100) size and up; PTFE liner, all sizes. OIML R49-1 MID MI-001 AWWA C715 WRAS (hard rubber) ACS (PTFE)

M5000 Amplifier Dimensions in Inches (Millimeters)

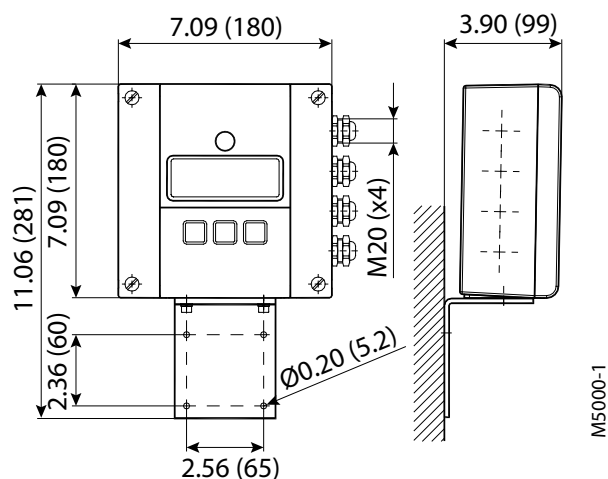

Flange ANSI Class 150 ASME B16.5

Size DN		A Standard		A ISO*		B1		B2		D		K		d2 x n	
inch	mm	inch	mm	inch	mm	inch	mm	inch	mm	inch	mm	inch	mm	inch	mm
1/2	15	6.7	170	7.9	200	9.4	238	11.7	298	3.5	89	2.4	61	0.6 x 4	16 x 4
3/4	20	6.7	170	7.9	200	9.4	238	11.7	298	3.9	99	2.8	71	0.6 x 4	16 x 4
1	25	8.9	225	7.9	200	9.4	238	11.7	298	4.3	109	3.1	79	0.6 x 4	16 x 4
1-1/4	32	8.9	225	7.9	200	10.0	253	12.3	313	4.6	117	3.5	89	0.6 x 4	16 x 4
1-1/2	40	8.9	225	7.9	200	10.0	253	12.3	313	5.0	127	3.9	99	0.6 x 4	16 x 4
2	50	8.9	225	7.9	200	10.0	253	12.3	313	6.0	152	4.8	122	0.8 x 4	19 x 4
2-1/2	65	11.0	280	7.9	200	10.7	271	13.0	331	7.0	178	5.5	140	0.8 x 4	19 x 4
3	80	11.0	280	7.9	200	10.7	271	13.0	331	7.5	191	6.0	152	0.8 x 4	19 x 4
4	100	11.0	280	9.8	250	10.9	278	13.3	338	9.0	229	7.5	191	0.8 x 8	19 x 8
5	125	15.7	400	9.8	250	11.7	298	14.1	358	10.0	254	8.5	216	0.9 x 8	22 x 8
6	150	15.7	400	11.8	300	12.2	310	14.6	370	11.0	279	9.5	241	0.9 x 8	22 x 8
8	200	15.7	400	13.8	350	13.3	338	15.7	398	13.5	343	11.8	300	0.9 x 8	22 x 8
10	250	19.7	500	17.7	450	14.3	362	16.6	422	16.0	406	14.3	363	1.0 x 12	25 x 12
12	300	19.7	500	19.7	500	16.7	425	19.1	485	19.0	483	17.0	432	1.0 x 12	25 x 12
14	350	19.7	500	21.7	550	17.7	450	20.1	510	21.0	533	18.8	478	1.1 x 12	28 x 12
16	400	23.6	600	23.6	600	18.7	475	21.1	535	23.5	597	21.3	541	1.1 x 16	28 x 16
18	450	23.6	600	23.6	600	19.7	500	22.0	560	25.0	635	22.8	579	1.3 x 16	32 x 16
20	500	23.6	600	23.6	600	20.7	525	23.0	585	27.5	699	25.0	635	1.3 x 20	32 x 20
24	600	23.6	600	23.6	600	23.1	588	25.5	648	32.0	813	29.5	749	1.4 x 20	35 x 20

Other sizes on request

IMPORTANT: ISO* sensor lay length according to ISO 20456

Flange ANSI Class 300 ASME B16.5

Size DN		A Standard		A ISO*		B1		B2		D		K		d2 x n	
inch	mm	inch	mm	inch	mm	inch	mm	inch	mm	inch	mm	inch	mm	inch	mm
1/2	15	6.7	170	7.9	200	9.4	238	11.7	298	3.8	95	2.6	67	0.6 x 4	16 x 4
3/4	20	6.7	170	7.9	200	9.4	238	11.7	298	4.6	117	3.3	83	0.8 x 4	19 x 4
1	25	8.9	225	7.9	200	9.4	238	11.7	298	4.9	124	3.5	89	0.8 x 4	19 x 4
1-1/4	32	8.9	225	7.9	200	10.0	253	12.3	313	5.3	133	3.9	99	0.8 x 4	19 x 4
1-1/2	40	8.9	225	7.9	200	10.0	253	12.3	313	6.1	155	4.5	114	0.9 x 4	22 x 4
2	50	8.9	225	7.9	200	10.0	253	12.3	313	6.5	165	5.0	127	0.8 x 8	19 x 8
2-1/2	65	11.0	280	7.9	200	10.7	271	13.0	331	7.5	191	5.9	149	0.9 x 8	22 x 8
3	80	11.0	280	7.9	200	10.7	271	13.0	331	8.3	210	6.6	168	0.9 x 8	22 x 8
4	100	11.0	280	9.8	250	10.9	278	13.3	338	10.0	254	7.9	200	0.9 x 8	22 x 8
5	125	15.7	400	9.8	250	11.7	298	14.1	358	11.0	279	9.3	235	0.9 x 8	22 x 8
6	150	15.7	400	11.8	300	12.2	310	14.6	370	12.5	318	10.6	270	0.9 x 12	22 x 12
8	200	15.7	400	13.8	350	13.3	338	15.7	398	15.0	381	13.0	330	1.0 x 12	25 x 12
10	250	19.7	500	17.7	450	14.3	362	16.6	422	17.5	445	15.3	387	1.1 x 16	28 x 16
12	300	19.7	500	19.7	500	16.7	425	19.1	485	20.5	521	17.8	451	1.3 x 16	32 x 16
14	350	19.7	500	21.7	550	17.7	450	20.1	510	23.0	584	20.3	514	1.3 x 20	32 x 20
16	400	23.6	600	23.6	600	18.7	475	21.1	535	25.5	648	22.5	572	1.4 x 20	35 x 20
18	450	23.6	600	23.6	600	19.7	500	22.0	560	28.0	711	24.8	629	1.4 x 24	35 x 24
20	500	23.6	600	23.6	600	20.7	525	23.0	585	30.5	775	27.0	686	1.4 x 24	35 x 24
24	600	23.6	600	23.6	600	23.1	588	25.5	648	36.0	914	32.0	813	1.6 x 24	41 x 24

Other sizes on request

IMPORTANT: ISO* sensor lay length according to ISO 20456

Flange EN 1092-1 / PN 10

Size DN		A Standard		A ISO*		B1		B2		D		K		d2 x n	
inch	mm	inch	mm	inch	mm	inch	mm	inch	mm	inch	mm	inch	mm	inch	mm
8	200	15.7	400	13.8	350	13.3	338	15.7	398	13.4	340	11.6	295	0.9 x 8	22 x 8
10	250	19.7	500	17.7	450	14.3	362	16.6	422	15.6	395	13.8	350	0.9 x 12	22 x 12
12	300	19.7	500	19.7	500	16.7	425	19.1	485	17.5	445	15.7	400	0.9 x 12	22 x 12
14	350	19.7	500	21.7	550	17.7	450	20.1	510	19.9	505	18.1	460	0.9 x 16	22 x 16
16	400	23.6	600	23.6	600	18.7	475	21.1	535	22.2	565	20.3	515	1.0 x 16	26 x 16
18	450	23.6	600	23.6	600	19.7	500	22.0	560	24.2	615	22.2	565	1.0 x 20	26 x 20
20	500	23.6	600	23.6	600	20.7	525	23.0	585	26.4	670	24.4	620	1.0 x 20	26 x 20
24	600	23.6	600	23.6	600	23.1	588	25.5	648	30.7	780	28.5	725	1.2 x 20	30 x 20

Other sizes on request

IMPORTANT: ISO* sensor lay length according to ISO 20456**Flange EN 1092-1 / PN 16**

Size DN		A Standard		A ISO*		B1		B2		D		K		d2 x n	
inch	mm	inch	mm	inch	mm	inch	mm	inch	mm	inch	mm	inch	mm	inch	mm
1/2	15	6.7	170	7.9	200	9.4	238	11.7	298	3.7	95	2.6	65	0.6 x 4	14 x 4
3/4	20	6.7	170	7.9	200	9.4	238	11.7	298	4.1	105	3.0	75	0.6 x 4	14 x 4
1	25	8.9	225	7.9	200	9.4	238	11.7	298	4.5	115	3.3	85	0.6 x 4	14 x 4
1-1/4	32	8.9	225	7.9	200	10.0	253	12.3	313	5.5	140	3.9	100	0.7 x 4	18 x 4
1-1/2	40	8.9	225	7.9	200	10.0	253	12.3	313	5.9	150	4.3	110	0.7 x 4	18 x 4
2	50	8.9	225	7.9	200	10.0	253	12.3	313	6.5	165	4.9	125	0.7 x 4	18 x 4
2-1/2	65	11.0	280	7.9	200	10.7	271	13.0	331	7.3	185	5.7	145	0.7 x 8	18 x 8
3	80	11.0	280	7.9	200	10.7	271	13.0	331	7.9	200	6.3	160	0.7 x 8	18 x 8
4	100	11.0	280	9.8	250	10.9	278	13.3	338	8.7	220	7.1	180	0.7 x 8	18 x 8
5	125	15.7	400	9.8	250	11.7	298	14.1	358	9.8	250	8.3	210	0.7 x 8	18 x 8
6	150	15.7	400	11.8	300	12.2	310	14.6	370	11.2	285	9.4	240	0.9 x 8	22 x 8
8	200	15.7	400	13.8	350	13.3	338	15.7	398	13.4	340	11.6	295	0.9 x 12	22 x 12
10	250	19.7	500	17.7	450	14.3	362	16.6	422	15.9	405	14.0	355	1.0 x 12	26 x 12
12	300	19.7	500	19.7	500	16.7	425	19.1	485	18.1	460	16.1	410	1.0 x 12	26 x 12
14	350	19.7	500	21.7	550	17.7	450	20.1	510	20.5	520	18.5	470	1.0 x 16	26 x 16
16	400	23.6	600	23.6	600	18.7	475	21.1	535	22.8	580	20.7	525	1.2 x 16	30 x 16
18	450	23.6	600	23.6	600	19.7	500	22.0	560	25.2	640	23.0	585	1.2 x 20	30 x 20
20	500	23.6	600	23.6	600	20.7	525	23.0	585	28.1	715	25.6	650	1.3 x 20	33 x 20
24	600	23.6	600	23.6	600	23.1	588	25.5	648	33.1	840	30.3	770	1.4 x 20	36 x 20

Other sizes on request

IMPORTANT: ISO* sensor lay length according to ISO 20456**Flange EN 1092-1 / PN 25**

Size DN		A Standard		A ISO*		B1		B2		D		K		d2 x n	
inch	mm	inch	mm	inch	mm	inch	mm	inch	mm	inch	mm	inch	mm	inch	mm
1/2	15	6.7	170	7.9	200	9.4	238	11.7	298	3.7	95	2.6	65	0.6 x 4	14 x 4
3/4	20	6.7	170	7.9	200	9.4	238	11.7	298	4.1	105	3.0	75	0.6 x 4	14 x 4
1	25	8.9	225	7.9	200	9.4	238	11.7	298	4.5	115	3.3	85	0.6 x 4	14 x 4
1-1/4	32	8.9	225	7.9	200	10.0	253	12.3	313	5.5	140	3.9	100	0.7 x 4	18 x 4
1-1/2	40	8.9	225	7.9	200	10.0	253	12.3	313	5.9	150	4.3	110	0.7 x 4	18 x 4
2	50	8.9	225	7.9	200	10.0	253	12.3	313	6.5	165	4.9	125	0.7 x 4	18 x 4
2-1/2	65	11.0	280	7.9	200	10.7	271	13.0	331	7.3	185	5.7	145	0.7 x 4	18 x 8
3	80	11.0	280	7.9	200	10.7	271	13.0	331	7.9	200	6.3	160	0.7 x 8	18 x 8
4	100	11.0	280	9.8	250	10.9	278	13.3	338	9.3	235	7.5	190	0.9 x 8	22 x 8
5	125	15.7	400	9.8	250	11.7	298	14.1	358	10.6	270	8.7	220	1.0 x 8	26 x 8
6	150	15.7	400	11.8	300	12.2	310	14.6	370	11.8	300	9.8	250	1.0 x 8	26 x 8
8	200	15.7	400	13.8	350	13.3	338	15.7	398	14.2	360	12.2	310	1.0 x 8	26 x 12
10	250	19.7	500	17.7	450	14.3	362	16.6	422	16.7	425	14.6	370	1.2 x 12	30 x 12
12	300	19.7	500	19.7	500	16.7	425	19.1	485	19.1	485	16.9	430	1.2 x 12	30 x 16
14	350	19.7	500	21.7	550	17.7	450	20.1	510	21.9	555	19.3	490	1.3 x 16	33 x 16
16	400	23.6	600	23.6	600	18.7	475	21.1	535	24.4	620	21.7	550	1.4 x 16	36 x 16
18	450	23.6	600	23.6	600	19.7	500	22.0	560	26.4	670	23.6	600	1.4 x 20	36 x 20
20	500	23.6	600	23.6	600	20.7	525	23.0	585	28.7	730	26.0	660	1.4 x 20	36 x 20
24	600	23.6	600	23.6	600	23.1	588	25.5	648	33.3	845	30.3	770	1.5 x 20	39 x 20

Other sizes on request

IMPORTANT: ISO* sensor lay length according to ISO 20456

Flange EN 1092-1 / PN 40

Size DN		A Standard		A ISO*		B1		B2		D		K		d2 x n	
inch	mm	inch	mm	inch	mm	inch	mm	inch	mm	inch	mm	inch	mm	inch	mm
1/2	15	6.7	170	7.9	200	9.4	238	11.7	298	3.7	95	2.6	65	0.6 x 4	14 x 4
3/4	20	6.7	170	7.9	200	9.4	238	11.7	298	4.1	105	3.0	75	0.6 x 4	14 x 4
1	25	8.9	225	7.9	200	9.4	238	11.7	298	4.5	115	3.3	85	0.6 x 4	14 x 4
1-1/4	32	8.9	225	7.9	200	10.0	253	12.3	313	5.5	140	3.9	100	0.7 x 4	18 x 4
1-1/2	40	8.9	225	7.9	200	10.0	253	12.3	313	5.9	150	4.3	110	0.7 x 4	18 x 4
2	50	8.9	225	7.9	200	10.0	253	12.3	313	6.5	165	4.9	125	0.7 x 4	18 x 4
2-1/2	65	11.0	280	7.9	200	10.7	271	13.0	331	7.3	185	5.7	145	0.7 x 4	18 x 8
3	80	11.0	280	7.9	200	10.7	271	13.0	331	7.9	200	6.3	160	0.7 x 8	18 x 8
4	100	11.0	280	9.8	250	10.9	278	13.3	338	9.3	235	7.5	190	0.9 x 8	22 x 8
5	125	15.7	400	9.8	250	11.7	298	14.1	358	10.6	270	8.7	220	1.0 x 8	26 x 8
6	150	15.7	400	11.8	300	12.2	310	14.6	370	11.8	300	9.8	250	1.0 x 8	26 x 8
8	200	15.7	400	13.8	350	13.3	338	15.7	398	14.8	375	12.6	320	1.2 x 8	30 x 12
10	250	19.7	500	17.7	450	14.3	362	16.6	422	17.7	450	15.2	385	1.3 x 12	33 x 12
12	300	19.7	500	19.7	500	16.7	425	19.1	485	20.3	515	17.7	450	1.3 x 12	33 x 16
14	350	19.7	500	21.7	550	17.7	450	20.1	510	22.8	580	20.1	510	1.4 x 16	36 x 16
16	400	23.6	600	23.6	600	18.7	475	21.1	535	26.0	660	23.0	585	1.5 x 16	39 x 16
18	450	23.6	600	23.6	600	19.7	500	22.0	560	27.0	685	24.0	610	1.5 x 20	39 x 20
20	500	23.6	600	23.6	600	20.7	525	23.0	585	29.7	755	26.4	670	1.7 x 20	42 x 20
24	600	23.6	600	23.6	600	23.1	588	25.5	648	35.0	890	31.3	795	1.9 x 20	48 x 20
Other sizes on request															

IMPORTANT: ISO* sensor lay length according to ISO 20456

Error Limits

Measuring range	0.10...39.37 ft/s (0.03...12 m/s)
Pulse output	±0.4% of m.v. ±0.08 in./s (2 mm/s)
Repeatability	±0.1% of actual data



Reference conditions	
Ambient and fluid temperature	68° F (20° C)
Electr. conductivity	> 300 µS/cm
Warm-up period	60 min
Mounting conditions	> (10 DN) inlet pipe
	> (5 DN) outlet pipe
	Detector properly grounded and centered

OIML APPROVED METER

The M5000 is type approved according to the international water meter standards OIML R49. The meter is approved as Class I and Class II for the detector sizes 2...24 inches (DN 50...600).

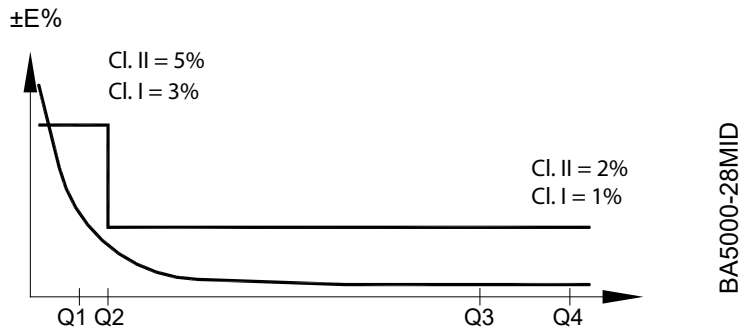

$Q2/Q1 = 1.6$ and $Q4/Q3 = 1.25$

OIML R 49 specification for Class I

Meter Size		Flow Rates [m ³ /h]				Ratio Q3/Q1
		Q1	Q2	Q3	Q4	
DN 50	2 in.	0.315	0.504	63	78.75	200
DN 65	2-1/2 in.	0.5	0.8	100	125	200
DN 80	3 in.	0.8	1.28	160	200	200
DN 100	4 in.	1	1.6	250	312.5	250
DN 125	5 in.	1.6	2.56	400	500	250
DN 150	6 in.	3.9375	6.3	630	787.5	160
DN 200	8 in.	6.25	10	1000	1250	160
DN 250	10 in.	10	16	1600	2000	160
DN 300	12 in.	15.625	25	2500	3125	160
DN 350	14 in.	15.625	25	2500	3125	160
DN 400	16 in.	25	40	4000	5000	160
DN 450	18 in.	39.375	63	6300	7875	160
DN 500	20 in.	39.375	63	6300	7875	160
DN 600	24 in.	50.4	80.64	6300	7875	125
OIML R49		Class I				

OIML R 49 specification for Class II

Meter Size		Flow Rates [m ³ /h]				Ratio Q3/Q1
		Q1	Q2	Q3	Q4	
DN 50	2 in.	0.315	0.504	63	78.75	200
DN 65	2-1/2 in.	0.5	0.8	100	125	200
DN 80	3 in.	0.8	1.28	160	200	200
DN 100	4 in.	1	1.6	250	312.5	250
DN 125	5 in.	1.6	2.56	400	500	250
DN 150	6 in.	2.52	4.032	630	787.5	250
DN 200	8 in.	6.4	10.24	1600	2000	250
DN 250	10 in.	6.4	10.24	1600	2000	250
DN 300	12 in.	10	16	2500	3125	250
DN 350	14 in.	10	16	2500	3125	250
DN 400	16 in.	16	25.6	4000	5000	250
DN 450	18 in.	25.2	40.32	6300	7875	250
DN 500	20 in.	25.2	40.32	6300	7875	250
DN 600	24 in.	40	64	10000	12500	250
OIML R49		Class II				

MID APPROVED METER (MI-001)

The M5000 is type approved according to Directive 2004/22/EC of the European Parliament and Council of March 31, 2004 Measuring Instruments (MID) Annex MI-001. The meter is approved for the detector sizes 2...24 inches (DN 50...600).

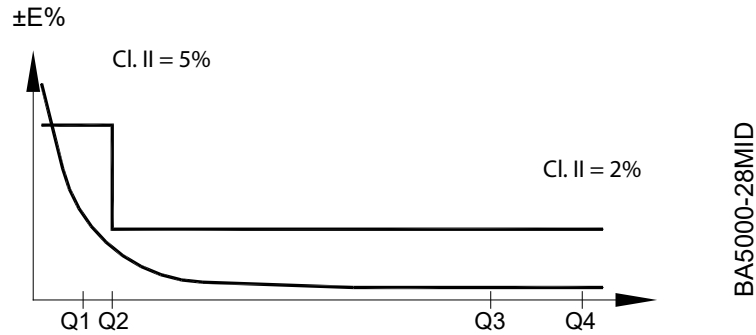

Q2/Q1 = 1.6 and Q4/Q3 = 1.25

Meter Size		Flow Rates [m ³ /h]				Ratio Q3/Q1
		Q1	Q2	Q3	Q4	
DN 50	2 in.	0.315	0.504	63	78.75	200
DN 65	2-1/2 in.	0.5	0.8	100	125	200
DN 80	3 in.	0.8	1.28	160	200	200
DN 100	4 in.	1	1.6	250	312.5	250
DN 125	5 in.	1.6	2.56	400	500	250
DN 150	6 in.	2.52	4.032	630	787.5	250
DN 200	8 in.	6.4	10.24	1600	2000	250
DN 250	10 in.	6.4	10.24	1600	2000	250
DN 300	12 in.	10	16	2500	3125	250
DN 350	14 in.	10	16	2500	3125	250
DN 400	16 in.	16	25.6	4000	5000	250
DN 450	18 in.	25.2	40.32	6300	7875	250
DN 500	20 in.	25.2	40.32	6300	7875	250
DN 600	24 in.	40	64	10000	12500	250
MID MI-001						

REPLACEMENT PARTS

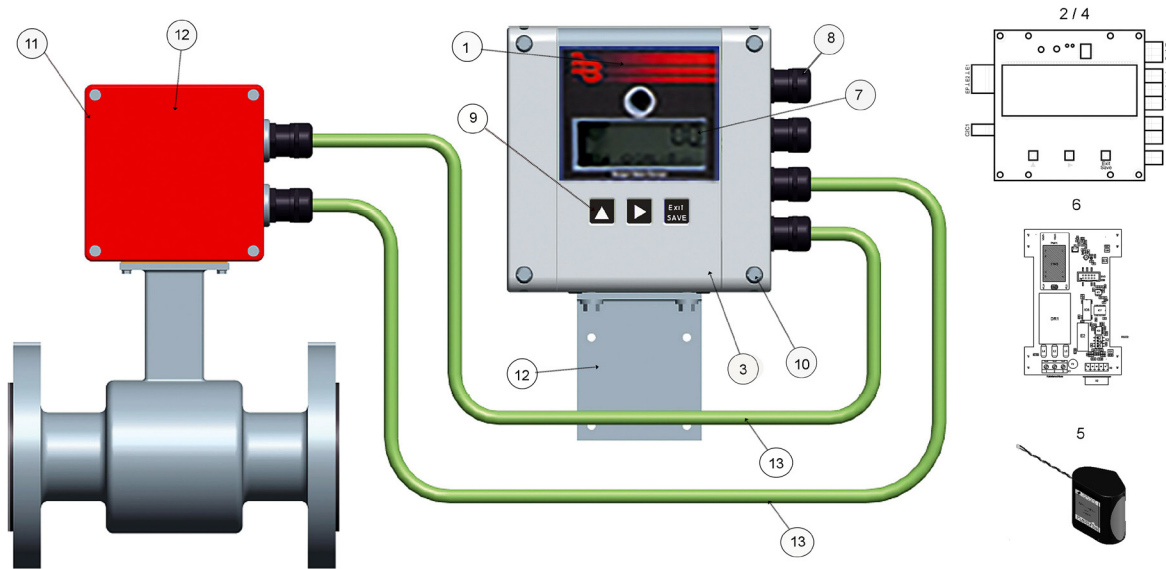

NOTE: For remote applications, two cables are required: An electrode cable and a coil cable.

Pos.	Description	North American Part no.	International Part no.		
1	Amplifier assembly complete				
	Complete without Batteries	—	592603		
	Complete with 2 D-cells	66902-003	592600		
	Complete with 4 D-cells	66902-004	592601		
2	PCB board assembly with amplifier cover, ADE and M-Bus	66902-007	384748		
	PCB board assembly with amplifier cover and RS485	66902-008	384759		
3	Housing / Cover (Complete)	66902-002	384735		
4	LCD display (only available with board)				
5	Battery pack 2 D-cells	66902-006	384776		
	Battery pack 4 D-cells	66902-005	384777		
6	Battery back-up board AC	—	384701		
	Battery back-up board DC	—	384741		
7	Display window	—	384709		
8	Cable gland	66862-001	384732		
9	Buttons kit black	—	384707		
10	Housing screws / Ball screws (Qty. 4)	66312-001	384607		
11	IP68 kit for remote version	—	383077		
12	Remote mounting kit less cable	63384-043	384870		
13	Remote mounting kit with cable				
		North America		International	
		Electrode Cable	Coil Cable	5 m	384871
	A-Cable: 15 ft	66897-001	66896-001	10 m	384872
	B-Cable: 30 ft	66897-002	66896-002	15 m	384873
	C-Cable: 50 ft	66897-003	66896-003	20 m	384874
	D-Cable: 100 ft	66897-004	66896-004	25 m	384875
	—	—	30 m	384876	
—	Data logging kit (required for firmware update)	67354-008	—		
	Verification device	66849-001	—		
	PC programming kit via USB/RS232	—	592604		
	PC programming kit via IrDA	—	592605		
	Grounding ring kits (for specific sizes, refer to the parts price list or contact your customer service account representative)	63528-xxx	—		

INTENTIONAL BLANK PAGE

Control. Manage. Optimize.

ModMAG and ORION are registered trademarks of Badger Meter, Inc. Other trademarks appearing in this document are the property of their respective entities. Due to continuous research, product improvements and enhancements, Badger Meter reserves the right to change product or system specifications without notice, except to the extent an outstanding contractual obligation exists. © 2023 Badger Meter, Inc. All rights reserved.

www.badgermeter.com