



TEK-WAVE 4300C

Free Space Radar Level Transmitter

Instruction Manual

Document Number: IM-4300C



Table of Contents

1	Safety Instructions	2
1.1	Intended Use	2
1.2	Safety Instructions from the Manufacturer	2
1.2.1	Disclaimer	2
1.2.2	Product Liability and Warranty	2
1.2.3	Information Concerning the Documentation	2
1.3	Safety Precautions	2
1.4	Packaging, Transportation and Storage	3
1.4.1	Packaging	3
1.4.2	Transportation	3
1.4.3	Storage	3
1.4.4	Nameplate	3
2	Product Description	4
2.1	Introduction	4
2.2	Working Principle	4
2.3	Specifications	5
2.4	Dimensional Drawings	6
2.5	Model Chart	7
3	Installations	7
3.1	Mounting Position	8
3.2	Installation at Conical Tank	8
3.3	Incorrect Installation	9
4	Electrical Connection	11
4.1	Wiring Connection	11
4.2	Protection Level	12
5	Operation	13
5.1	Instrument Commissioning	13
5.1.1	Different Debugging Method	13
5.2	Display or Adjustments	14
5.3	Menu	15
5.3.1	Program Submenu	15
5.3.2	Edit Parameter	15
5.3.3	Menu Instruction	16
6	Menu Tree	31

1 Safety Instructions

1.1 Intended Use

Tek-Wave 4300C Free Space Radar Level Transmitter is widely used to measure level of tanks, lakes, rivers or streams.

1.2 Safety Instructions from the Manufacturer

1.2.1 Disclaimer

The manufacturer will not be held accountable for any damage that happens by using its product, including, but not limited to, direct, indirect, or incidental and consequential damages. Any product purchased from the manufacturer is warranted by the relevant product documentation and our Terms and Conditions of Sale. The manufacturer has the right to modify the content of this document of any time with any reason without prior notice and will not be answerable for the possible consequence of changes.

1.2.2 Product Liability and Warranty

The operator shall have authority for the suitability of the device for the specific application. The manufacturer accepts no accountability for the consequences of misuse by the operator. A wrong installation or operation of the devices (systems) will cause the warranty to be void. The respective Terms and Conditions of Sale, which forms the basis for the sales contract, shall also apply.

1.2.3 Information Concerning the Documentation

To prevent any injury to the operator or damage to the device, it is essential to read the information in this document and the applicable national standard safety instructions. This operating manual consists of all the information that is required in various stages, such as product identification, incoming acceptance and storage, mounting, connection, operation and commissioning, troubleshooting, maintenance, and disposal.

1.3 Safety Precautions

You must read these instructions carefully before installing and commissioning the device. These instructions are an essential part of the product and must be kept for future reference. Only by observing these instructions, optimum protection of both personnel and the environment, as well as safe and fault-free operation of the device can be ensured. For additional information that is not discussed in this manual, contact the manufacturer.

The following safety symbol marks are used in this operation manual and on the instrument.



WARNING

Indicates a potentially hazardous situation which, if not avoided, could result in death or severe injury



CAUTION

Indicates a potentially hazardous situation which, if not avoided, may result in minor or moderate injury. It may also be used to alert against unsafe practices.



NOTE

Indicates that operating the hardware or software in this manner may damage it or lead to system failure.

1.4 Packaging, Transportation and Storage

1.4.1 Packaging

The original package consists of

1. Tek-Wave 4300C Free Space Radar Level Transmitter
2. Documentation



NOTE

Unpack and Check the contents for damages or sign of rough handling. Report damage to the manufacturer immediately. Check the contents against the packing list provided.

1.4.2 Transportation

- Avoid impact shocks to the device and prevent it from getting wet during transportation.
- Verify local safety regulations, directives, and company procedures with respect to hoisting, rigging, and transportation of heavy equipment.
- Transport the product to the installation site using the original manufacturer's packing whenever possible.

1.4.3 Storage

If this product is to be stored for an extended period of time before installation, take the following precautions:

- Store your product in the manufacturer's original packing used for shipping.
- The storage location should comply with the following requirements:
 - Free from rain and water
 - Free from vibration and impact shock
 - At room temperature with minimal temperature and humidity variation
- Before storing a used flow meter, remove any fluid from the flow meter line completely. Properties of the instrument can change when stored outdoors.

1.4.4 Nameplate

The nameplate lists the order number and other important information, such as design details and technical data.



NOTE

Check the device nameplate to ensure that the device is delivered according to your order. Check for the correct supply voltage printed on the nameplate.

2 Product Description

2.1 Introduction

Tek-Wave 4300C Free Space Radar Level Transmitter is 26GHz high frequency radar type level measuring instrument, which can measure up to 70 meters. The antenna is furthered optimized and the new fast microprocessor can carry out signal analysis and processing at a higher rate, therefore the Tek-Wave 4300C Free Space Radar Level Transmitter can be used for some complex measurement conditions such as reactor, solid bin etc.

2.2 Working Principle

The Tek-Wave 4300C Radar Level antenna transmits a narrow microwave pulse, which is transmitted downward through the antenna. When the microwave contacts the surface of the medium, it reflected and received by antenna again. This received signal transmitted to electronic circuit and converted into the material level signal.

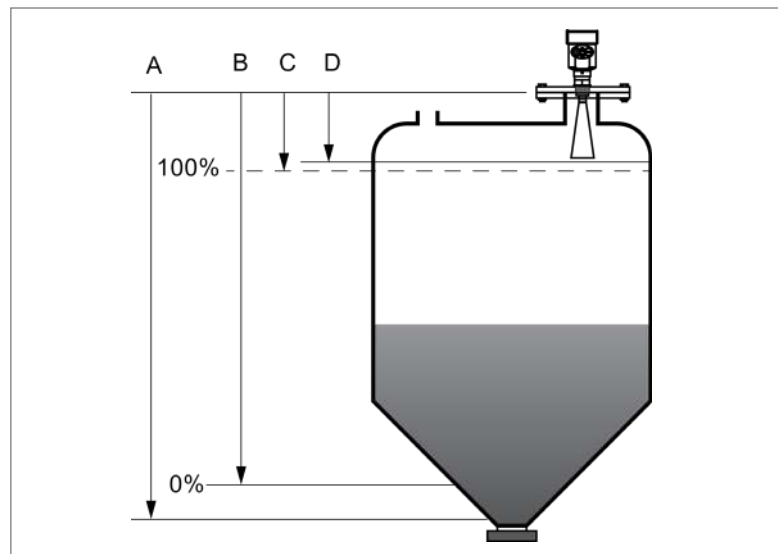

Fig 1: Tek-Wave 4300C Free Space Radar Level Transmitter

Where, A is Range Setting
B is Low Level Adjustment
C is High Level Adjustment
D is Blind Area Range

2.3 Specifications

Accuracy	±3mm
Measuring Range	90ft (30m)
Microwave Frequency	26GHz
Maximum Pressure	Max. 580psi (4Mpa)
Process Pressure	-14.50 to 580psi (0.1 to 4Mpa)
Operating Temperature	-40 to 212°F (-40 to 100°C)
Process Temperature	-40 to 482°F (-40 to 250°C)
Medium Temperature	-40 to 300°F (-40 to 150°C)
Shock Resistance	Mechanical vibration 32.80ft/s ² (10m/s ²), 10 to 150 Hz
Process Connection	NPT or Flange
Electrical Connection	½" NPT (Two)
Terminal Block	18 to 22 AWG Wire
Protection Class	IP67
Output Signal	4 to 20mA with HART® Optional Modbus RS485
Fault Signal	current output unchanged. 20.5mA; 22mA; 3.9mA
Integration time	0 to 50s adjustable
Power Supply	16 to 26VDC
Power Consumption	Max 22.5mA/1w
Permissive Ripple	- <100Hz U _{ss} <IV - (100 to 100K) Hz U _{ss} <10mV
Blind Area	Antenna end
Response Time	About 1 second (depending on parameter setting)
Display	LCD
Display Resolution	1mm
Beam Angle	18°
Approval	CE

2.4 Dimensional Drawings

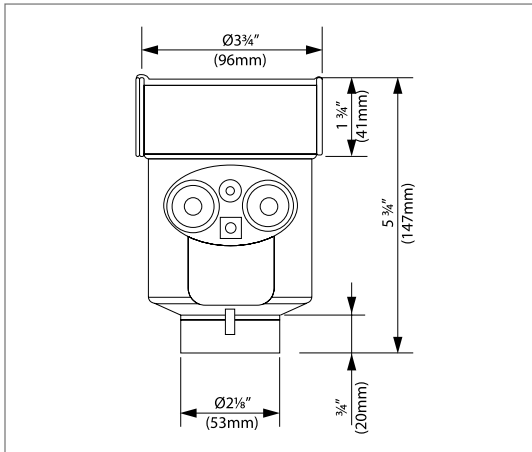

Fig 2: Front View

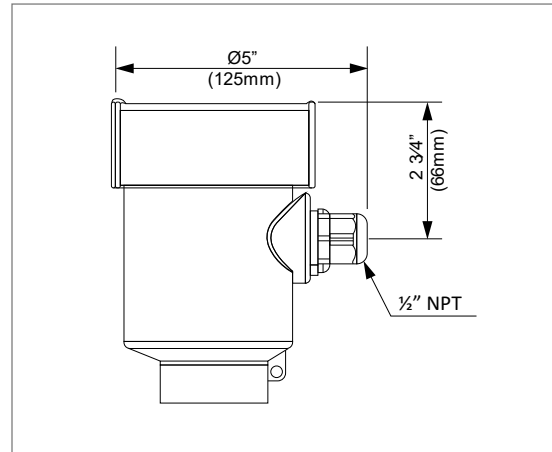

Fig 3: Side View

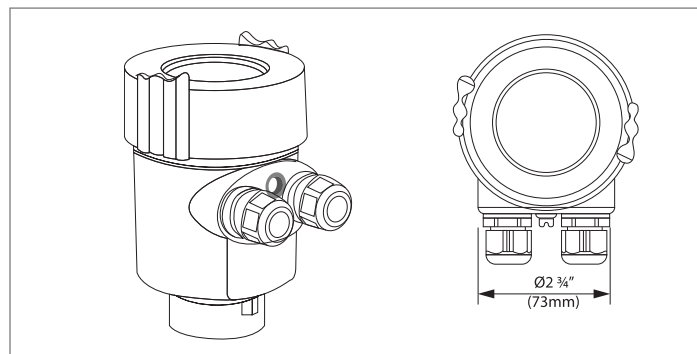

Fig 4: Top View

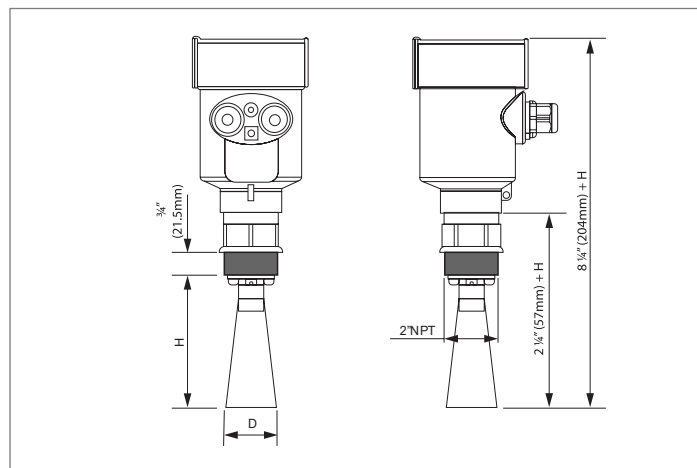

Fig 5: Tek-Wave 4300C Free Space Radar Level Transmitter

Line Size in (mm)	D in (mm)	H in(mm)
2" (50)	1 3/4" (φ46)	5 1/2" (140)

2.5 Model Chart

Example	Tek-Wave 4300C	1	A	1	A	1	A	1	Tag	Tek-Wave 4300C-01-A-01—A-01-A-01-Tag
Series	Tek-Wave 4300C									Free Space Radar Level Transmitter
Output		1 2								4-20mA, HART (2-wire) Modbus RS-485 (4-wire)
Pressure Limits			A X							-14.5 to 580psi (0.1 to 4Mpa) Special
Temperature Limits				1 2						Standard: -40 to 300°F (-40 to 150°C) High: -40 to 482°F (-40 to 250°C)
Process Connection					A B C D X					2" NPT 3" 150# Flange 4" 150# Flange 3" 300# Flange Special
Electrical Connection						1 X				½" NPT (Two) Special
Power Supply							A X			16 to 26VDC Special
Range								1		90 feet (30 Meters)
Options									TAG FC	SS Tag Factory Configuration

3 Installations

This section covers instruction on installations and commissioning. Installations of the device must be carried out by trained, qualified specialists authorized to perform such works.



CAUTION

- When removing the instrument from hazardous processes, avoid direct contact with the fluid and the meter.
- All installation must comply with local installation requirements and local electrical code

3.1 Mounting Position

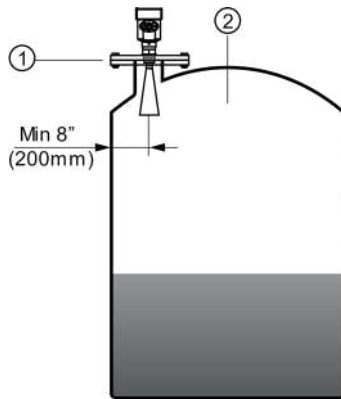

1 Reference Plane

2 Vessel Center or Symmetrical Axis

Fig 6: Installation at 1/4 or 1/6 of Diameter

- Install at 1/4 or 1/6 of the diameter.
- Minimum distance of 8" (200mm) between instrument and vessel all during installation

3.2 Installation at Conical Tank

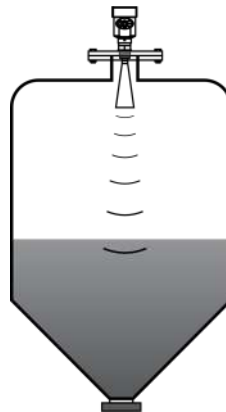

Fig 7: Installation at Conical Tank in Top Plane

- The conical tank's top plane can be installed in the middle of the tank top to ensure that the cone bottom can be measured.

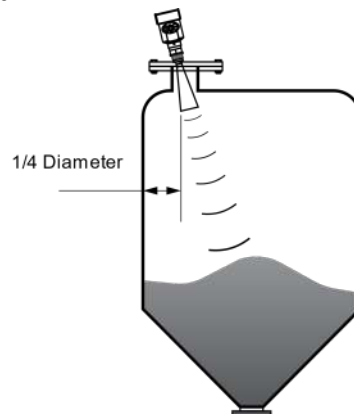

Fig 8: Installation at Conical Tank in inclined Plane

- When there is a material pile, the antenna must be vertically aligned with the material surface.
- If the material surface is uneven, the angle of the horn must be adjusted by the universal flange to align the horn with the material surface as much as possible (because the inclined solid surface may cause echo attenuation or even signal loss).

3.3 Incorrect Installation

- The conical tank cannot be installed above the feed port.



CAUTION

Sunshade and rainproof measures shall be taken during outdoor installation.

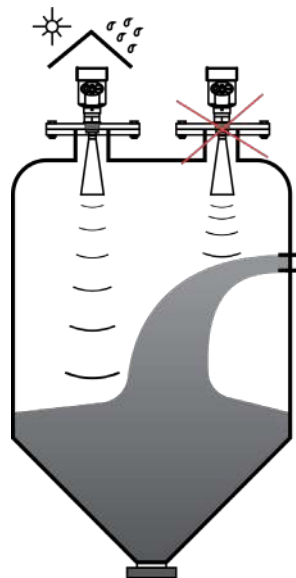
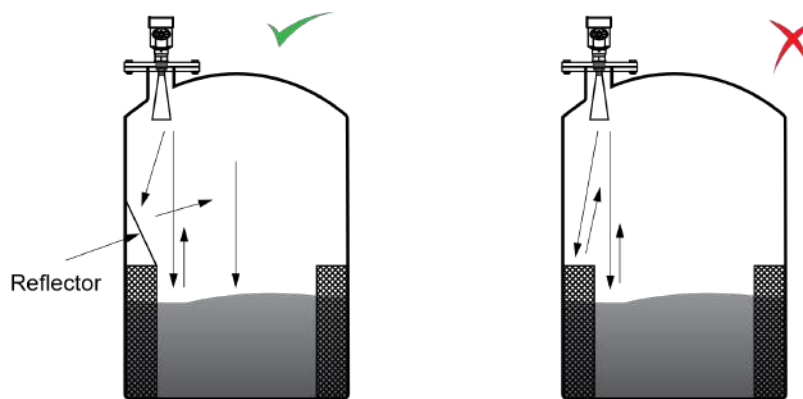

Fig 9: Installation at Conical Tank

- When there is an obstacle in the tank that affects the measurement, installing a reflection plate for normal measurement is necessary.



Reflect the obstacle signal

Fig 10: Installation of Reflection Plate

- The instrument shall not be installed in the middle of the arch or round tank top.
- Indirect echo will be affected by multiple echoes.
- Multiple echoes may have a larger signal threshold than real echoes because multiple echoes can be concentrated through the top. Therefore, it cannot be installed in the center position.

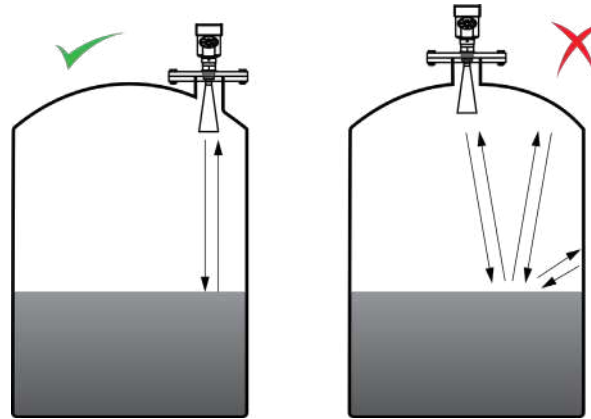

Fig 11: Installation at Round Tank

- Height requirement of connecting pipe: the antenna must extend at least 3/8" (10mm) into the tank.

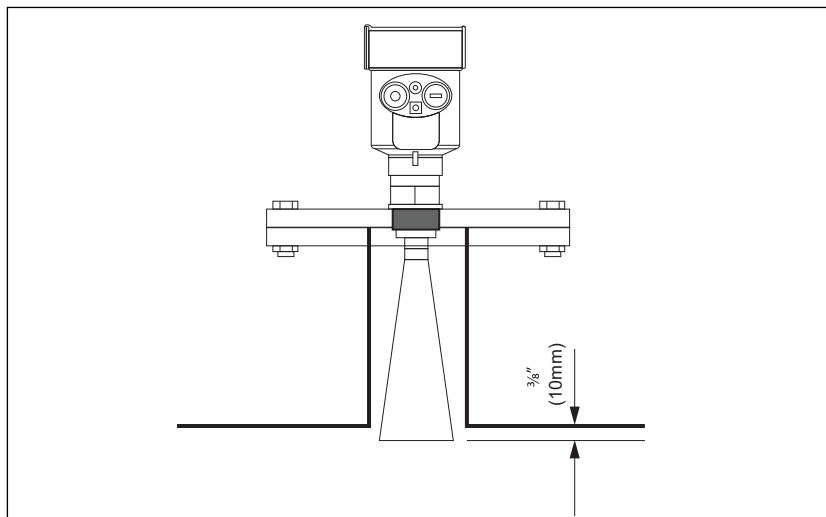

Fig 12: Installation with Height Requirement

4 Electrical Connection

This section covers all electrical connection requirement. Electrical connection of the device must be carried out by trained; qualified specialists authorized to perform such work by the installation site.



WARNING

- Connect all electrical cables when the power is switched off. If the device does not have switch-off elements, then, overcurrent protection devices, lightning protection and/or energy isolating devices must be provided by the customer.
- The device must be grounded to a spot in accordance with regulations in order to protect personnel against electric shocks.



NOTE

When using the measuring device in hazardous areas, installation must comply with the corresponding national standards and regulations and the Safety Instructions or Installation or Control Drawings.

4.1 Wiring Connection

- 4 to 20mA or Hart (two-wire system) power supply and output current signal share a two-core shielded cable.
- Refer to technical data for specific power supply voltage range.
- A safety barrier should be placed between the power supply and instrument for an intrinsically safe version.
- Standard 2- wire cable with an outside diameter of 5...9mm is used to assures the sealing effect of cable entry. It can be used as a feeder cable.
- You are recommended to use screened cables in electromagnetic Connection cable with special earth wire used as feeder cable.

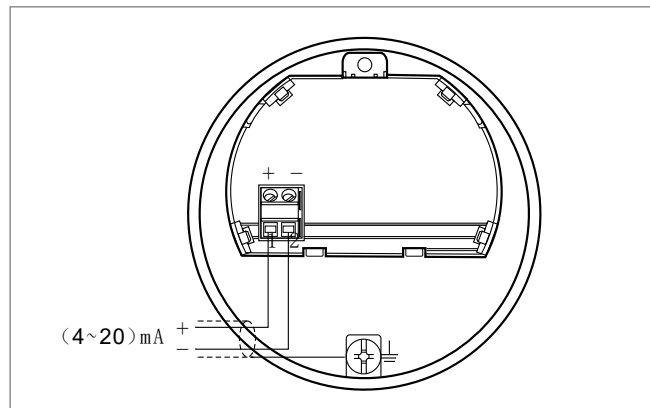

Fig 13: Two-Wire System Wiring Diagram

- RS485/MODBUS power supply and MODBUS signal line respectively use a shielded cable.
- Refer to the technical data for the specific power supply voltage range.

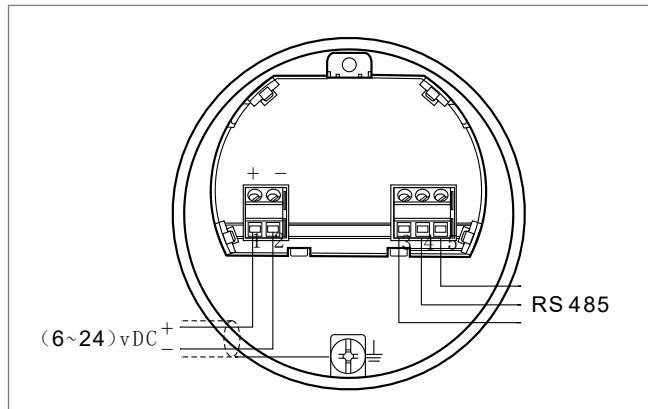

Fig 14: 24V RS485/Modbus Wiring Diagram



NOTE

- Please observe the requirements of the local electrical installation regulations!
- Please observe the local regulations on the health and safety of personnel. All operations of electrical components of instruments must be completed by professional personnel who have received formal training.
- Please check the nameplate of the instrument to ensure that the product specifications meet your requirements. Please ensure that the supply voltage is consistent with the requirements on the instrument nameplate.

4.2 Protection Level

- The Tek-Wave 4300A Free Space Radar Level Transmitter fully meets the requirements of protection grade IP66/67.
- Please ensure the water resistance of cable sealing head as shown in figure 15:

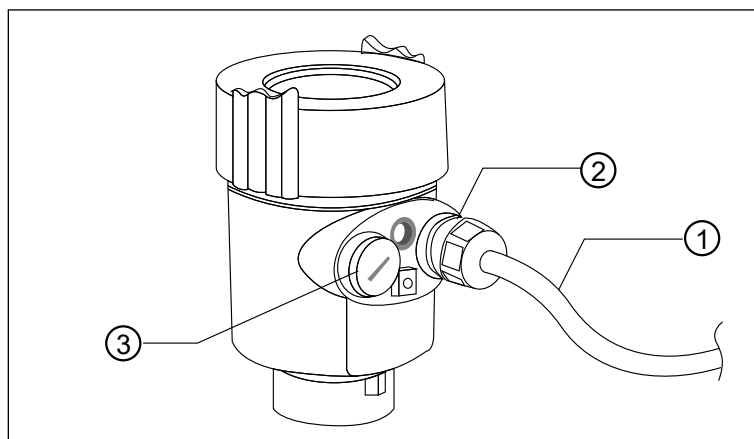

Fig 15: Protection Level

- How to ensure that the installation meets the requirements of IP67:
 - Make sure that the sealing head is not damaged.
 - Make sure the cable is not damaged.

- Make sure that the cables are used to meet the requirements of the electrical connection specifications.
- Before entering the electrical interface, bend the cable downward to ensure that the water will not flow into the shell, see ①
- Please tighten the cable sealing head, see ②
- Please block the unused electrical interface with a blind plug, see ③

5 Operation

5.1 Instrument Commissioning

5.1.1 Different Debugging Method

- Display or Key
- Upper computer debugging
- Hart hand programmer

5.1.1.1 Display or Key

- The instrument is debugged by four buttons on the display screen.
- The language of the debug menu is optional.
- After debugging, it is generally used for display and the measured value can be read out very clearly through the glass window.

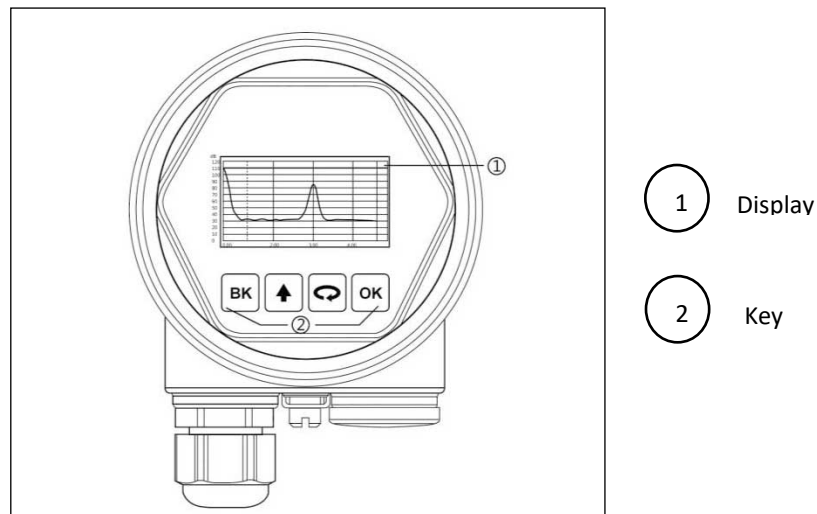
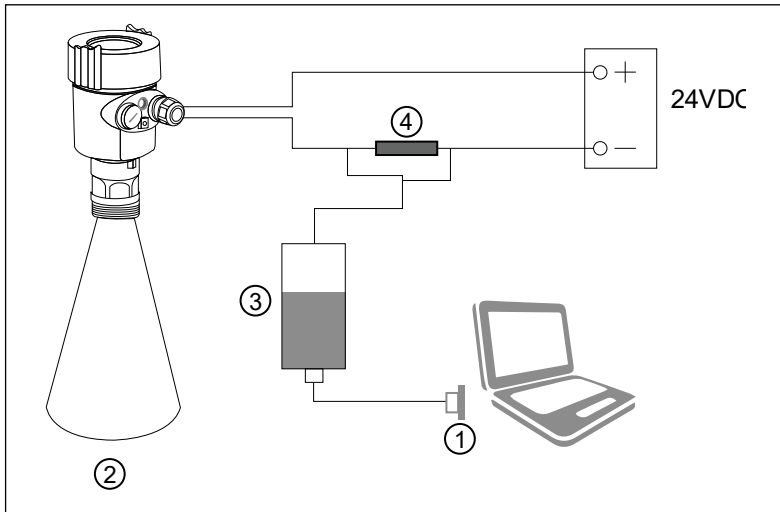

Fig 16: Display or Key

5.1.1.2 Upper Computer Debugging Connect to the upper computer through HART



- 1 RS232 interface / USB interface
- 2 Tek-Wave 4300C Free Space Radar Level Transmitter
- 3 HART adapter
- 4 250Ω resistance

Fig 17: Connection to the computer through HART

5.1.1.3 HART Handheld Programmer Programming

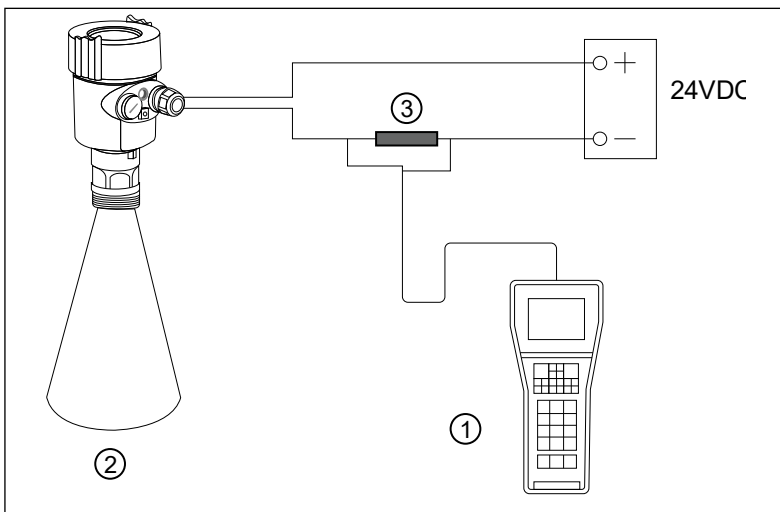

- 1 HART Hand Programmer
- 2 Tek-Wave 4300C Free Space Radar Level Transmitter
- 3 250Ω resistance

Fig 18: HART Handheld Programmer

5.2 Display or Adjustments

- Adjustments can be done with four buttons on the view point.
- Optional menu languages are available.
- View point is only used for display after adjustments.
- Measurement results would be displayed on the LCD.

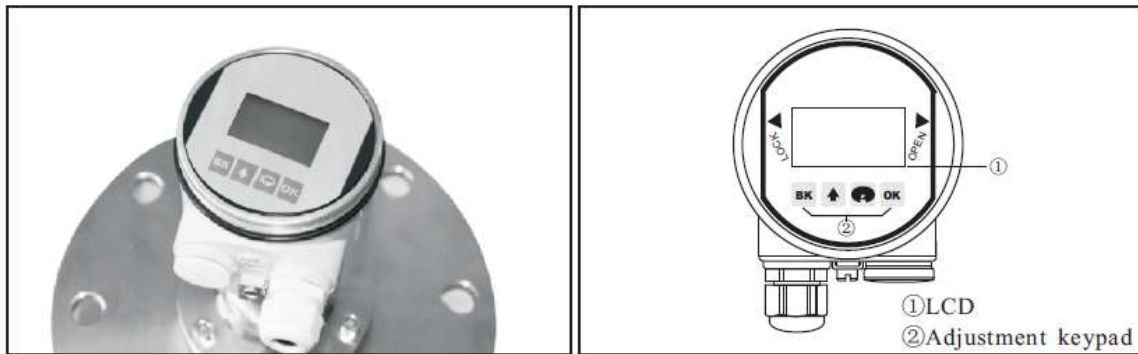









Fig 19: Display of Tek-Wave 4300C

Table 1: Display Keys and its function



Display Key	Function
	Enter programming mode; Confirm programming options and modifications to parameters
	Modify parameter values and select display mode
	Select programming options and digit of parameters to edit; Display the contents of parameters
	Exit programming mode and return to higher menu level; Display Echo Wave

5.3 Menu

5.3.1 Program Submenu

- **Basic settings:** Basic adjustments for the sensor are included in this menu. They are min. & max. adjustment, medium, damping time, Mapping curve, scaled units, Scaling, Near blanking and sensor tag.
- **Display:** In this menu you can setup the sensor display mode and adjust B/W contrast for LCD.
- **Diagnostic:** In this menu you can check and test sensor. You can view the measurement peak values, Status & echo-curve and Simulation.
- **Service:** Here you can store false echo curve and current output settings, Unit of measurement, language, reset, HART operation mode, copy sensor data and PIN.
- **Info:** The Information of sensor including sensor type, serial number, date of manufacture, Software version.
- **Program Operation:** Enter program mode by press . Press  after each parameter editings. otherwise, the modification will be abandoned. Press  to quit program status.

5.3.2 Parameter Editing

- The first digit of the edit parameter is displayed in black background.
- Modify digit with .
- Edit next digit with .
- After editing, press  to confirm and store the modification.

5.3.3 Menu Instruction

5.3.3.1 Basic Settings

- These settings are basic setup of the sensor such as minimum and maximum adjustment, medium, damping etc.
- Press **OK** to bring the sensor to program mode from run mode. Then the menu is displayed as shown below

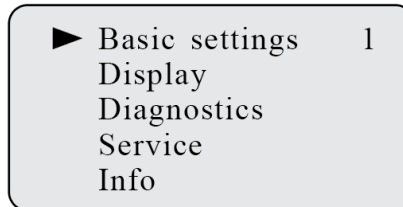

*Note: The menu item number is displayed on the top right corner.

5.3.2.1.1 Minimum Adjustment

- Minimum adjustment setting regulates the linear scaled current output.
- At main menu, select basic settings with **↩** and press **OK** to confirm.

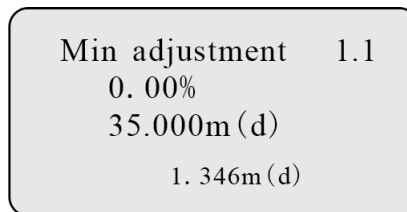

- Press **OK** for edit the percentage value.
- Press again **OK** to confirm the modification and furthermore you can edit the corresponding distance value please refer edit parameter section to edit parameters.

5.3.2.1.2 Maximum Adjustments

- Maximum adjustment setting regulates the linear scaled current output.
- At main menu, select basic settings with **↩** and press **OK** to confirm.

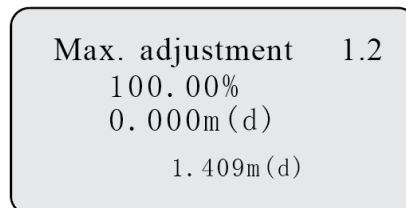



- Press **OK** for edit the percentage value.
- Press **OK** again to confirm the modification and furthermore you can edit the corresponding distance value please refer edit parameter section to edit parameters.

5.3.2.1.3 Medium

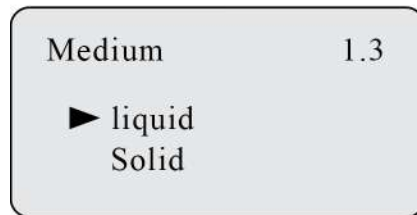
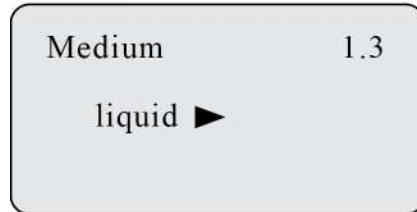
- Each medium has different reflective properties.
- This menu is used to set the medium to be solid or liquid and another relative factor.



- Move arrow with .
- Solid or liquid medium can be selected.
- Press  to confirm the selection and enter Fast level change submenu.
 - Fast Level Change

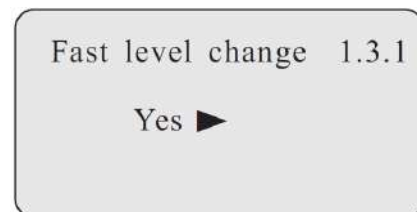

- Press  to enter Fast Level Change Confirmation.

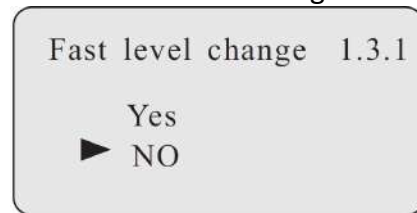

- Move arrow with  to Select Yes or No for Fast level change.
- Press  to confirm the selection

- First Echo

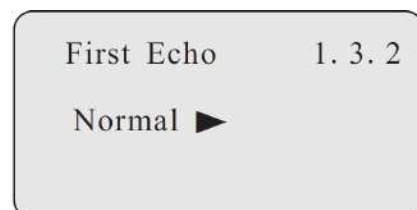

- Press to enter First Echo menu.
- Press to select to way to set First Echo
- There are five ways to set First Echo
 - Normal: No adjustments on first echo
 - Small: Decrease first echo by 10dB
 - Big: Increase first echo by 10dB
 - Bigger: Increase first echo by 20dB
 - Biggest: Increase first echo by 40dB

➤ Agitated Surface or Large Angler Repose

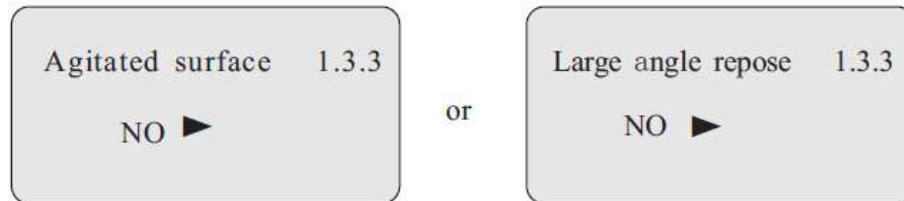

- Press to enter Agitated surface or Large angler repose menu.

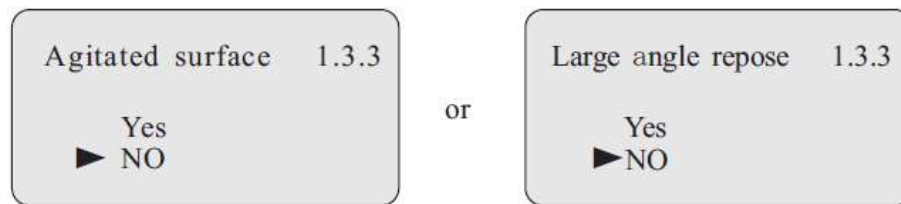

- Press to move the arrow, select whether the liquid surface is fluctuating or whether the solid is a large number of angles.
- Press to confirm the selection.

➤ Foaming or Powder Dust

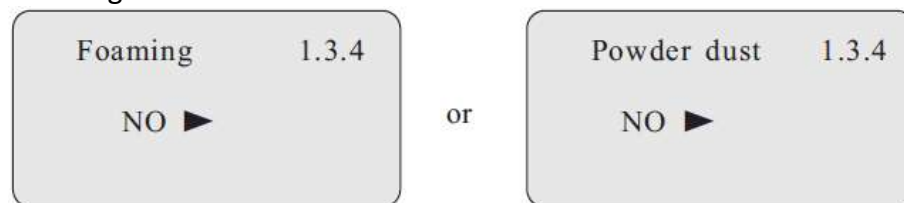

- Press to enter the submenu of foaming or powder dust confirmation.

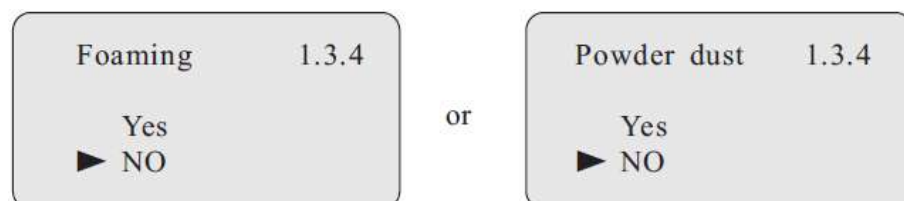

- Press to move the arrow, select the liquid foam or solid dust strong measurement environment.
- Press to confirm the selection.
- Press to exit material properties edit menu.

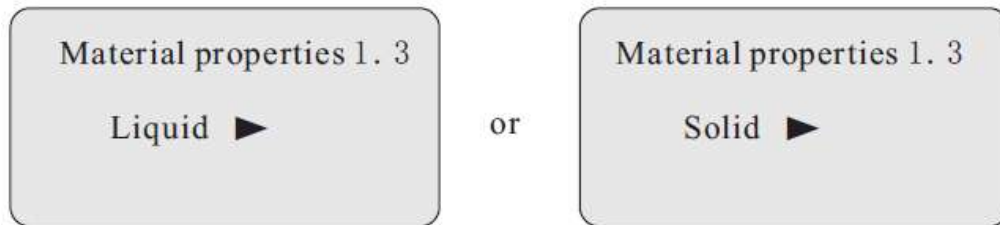

➤ Low DK

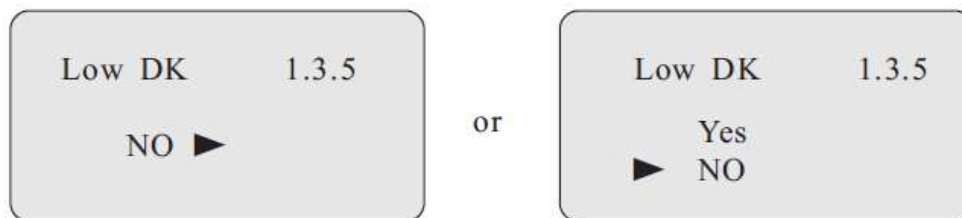

- Press to move the arrow, select Yes or No for medium with Low DK.
- Press to confirm the selection.

➤ Measuring in Tube

- When measurement is carried through a tube, it is limited for the liquid medium.
- The tube diameter must be set in this menu to rectify the measuring error.

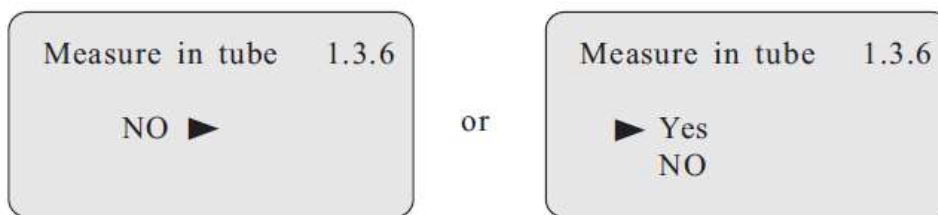

- If the selection is Yes then confirmed by , the tube diameter is required.

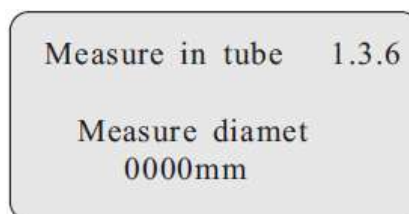

- Press the value can be edited.

5.3.2.1.4 Damping



- Press **OK** to enter edit menu.
- Press **OK** to confirm the modification.
- Press **BK** to exit.

5.3.2.1.5 Mapping Curve

- This menu defines the correlation between the measured value and the output current.
- Linear or non-linear mapping can be selected in this menu.
- For the non-linear correlations, parameters setting must be done by a computer previously.

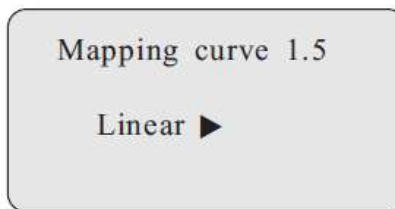

- Press **↶** to move the arrow, select linear or non-linear.
- Press **OK** to confirm the modification.

5.3.2.1.6 Scaled Units

- The unit of the scaled output value can be set in this menu.

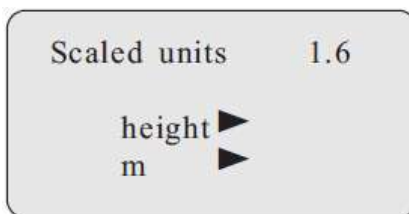

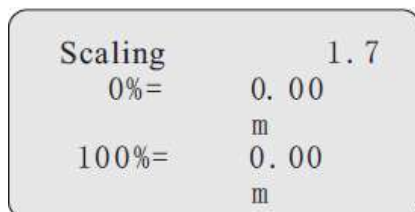

5.3.2.1.7 Scaling

- Edit parameter value.
- Press **OK** to confirm the modification.



5.3.2.1.8 Range

- Measure range should be set in order to get accurate result.
- Press  to enter Range.
- Press  to confirm the modification.
- Press  to cancel.

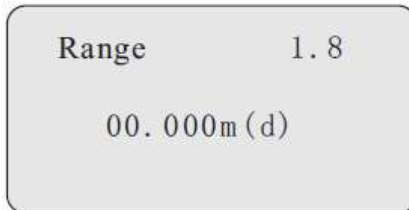

5.3.2.1.9 Blind Area

- When a stationary obstacle is measured near the surface of the sensor and the maximum height is not reached, you can use the setting function of the blind area to avoid measuring errors.
- Press  to enter the blind area setting menu.

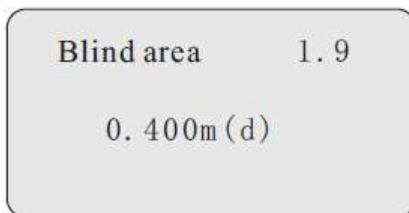

5.3.2.1.10 Sensor Tag

- In the menu Sensor TAG you edit a 11-digit measurement loop designation.
- The character set comprises letters from A-Z and Numbers from 0-9.

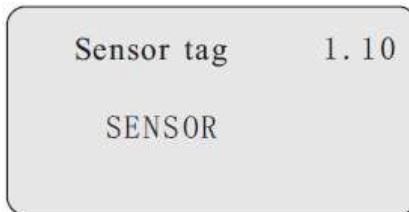

5.3.2.2 Display

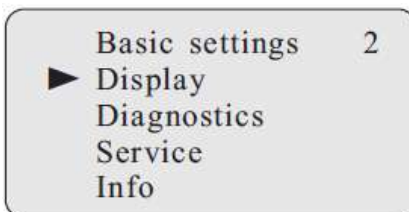

- Press  to confirm.

5.3.2.2.1 Display Value

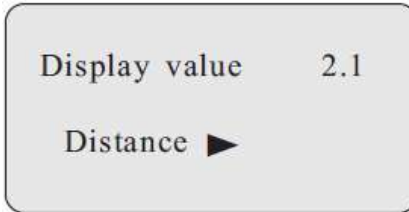

- Press to select different display types of the measured value.

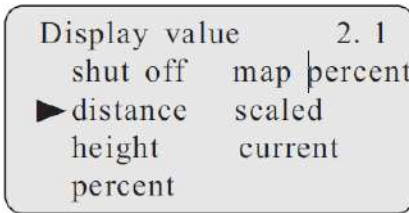

- Press to confirm.

5.3.2.2.2 LCD Contrast adjustments

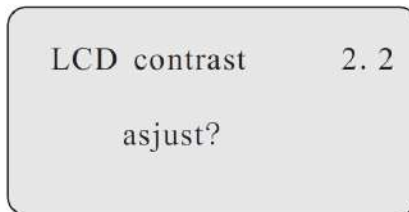

- Press to adjust the B/W contrast.

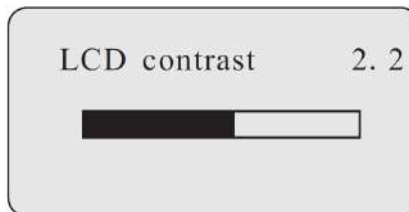

- Increase contrast with , decrease contrast with . Confirm with .

5.3.2.3 Diagnostics

- Diagnostics menu provides running status of the sensor

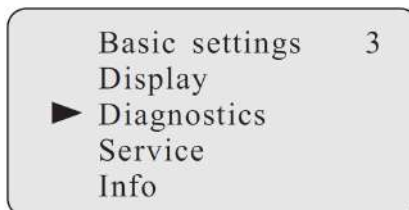

- Press to confirm.

5.3.2.3.1 Peak Values

- It records the maximal and minimal distance.
- The records can be cleared to zero at menu.

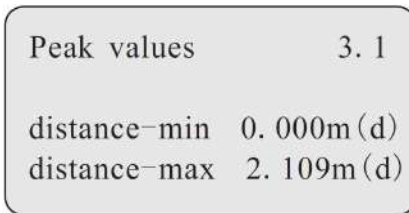

5.3.2.3.2 Measurement Status

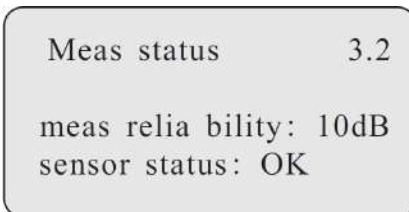

5.3.2.3.3 Echo Curve

- In this menu, different curves can be selected to be displayed.

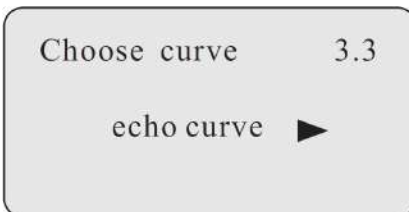

- Press to select the curve.

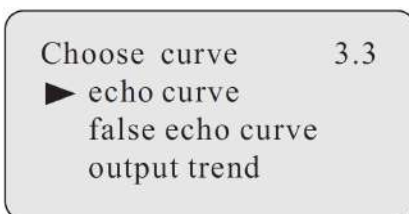

- When the curve is displayed by enter Curve Zoom function menu.

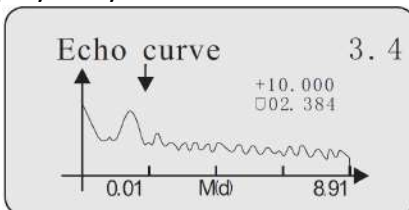

- Press to select menu for X Y axis zoom in or zoom out.
- Press to confirm.
- For X axis zoom through to mark the start position for zoom.
- Press to confirm.

- Press again to mark zoom end position.
- Press to confirm.
- Press to exit.

5.3.2.3.4 Simulation

- Simulation is used to simulate the 4 to 20mA output current.
- The accuracy and linearity of the output current can be checked by simulation.

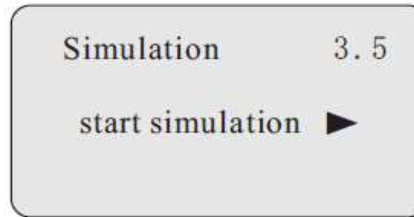

- Press to enter simulation mode.

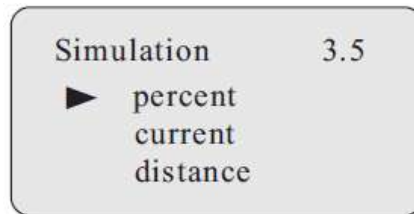

- Press to select simulation mode.
- Press to confirm.
- Three types of simulation as follows:
 - Percent: The output current is decided by a percent value:100% is relative to 20mA,0% is relative to 4mA.
 - Current: the output current is regulated by a current value.
 - Distance: the output current is decided by a distance value.
 - The output current depends on minimum, maximum adjustments and mapping.

5.3.2.4 Service

- Trained technicians can only use this menu with professional functions.
- They are False echo storage, reset, sensor settings back up Password setting.

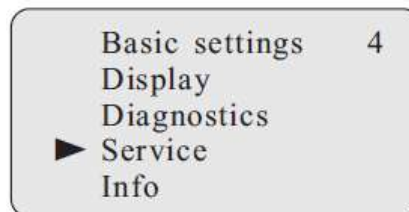

5.3.2.4.1 False Echo

- High sockets or vessel installations, e.g., struts or agitators and build-up and weld joints on the vessel walls, cause interfering reflections that can impair the measurement.
- False echo storage detects and marks these false echoes to no longer be considered for the level measurement. A false echo memory should be created with an empty vessel to detect all potential interfering reflections.

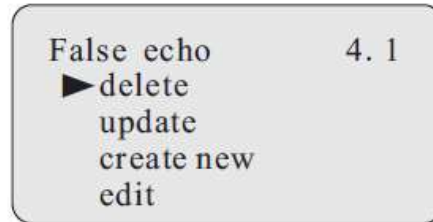
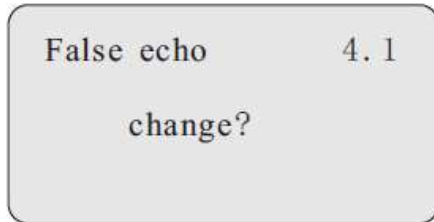

- Press to update or create new or delete a false echo.

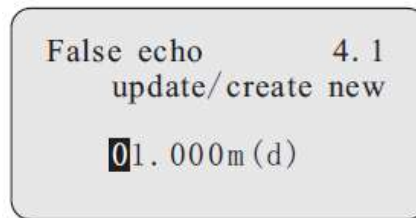

- After updating, input the distance value of real echo.
- Press to confirm.
- It will take some time to store the false echo to start the operation.

*Note: Check the distance to the product surface because if an incorrect (too large) value is entered, the existing level will be saved as a false signal. The filling level would then no longer be detectable in this area.

- To edit a false echo curve, press the button, move the arrow to the desired section will be present.
- Press to confirm.
- This feature has been built on false echo to edit or change to meet the special requirements of working conditions, access to virtual false echoes editing interface is as follows:

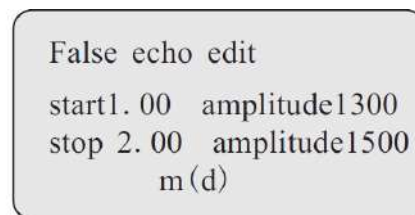
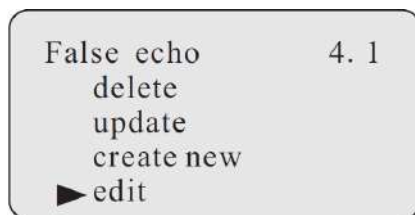

- Each curve edit points, start point and endpoint coordinates for the curve you want to edit, then the corresponding range of values is to modify the value

*Note: When the distance coordinate input or modified, then the rate will automatically be the root corresponding to the current saved data update rate changes used as a reference.

- Press **OK** to confirm the amendment.
- The instrument will automatically enter the two points into line with new false echo generated curve to replace the original curve.
- Press **OK** to confirm the interface will show the revised by this false echo curve.
- Edit **BK** to return edit menu.
- When the editor has been confirmed false echo, conditions required to be false.
- Press **BK** to exist edit menu.

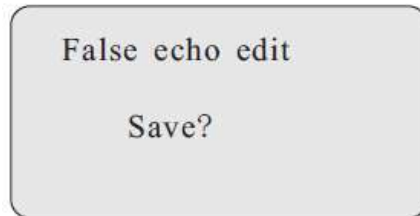

- Press **OK** to save the above changes.

5.3.2.5 Current Output

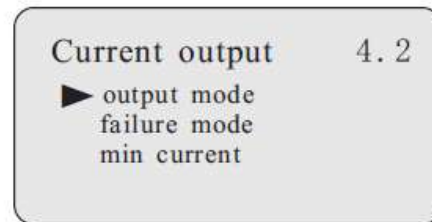
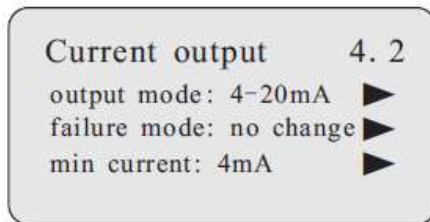

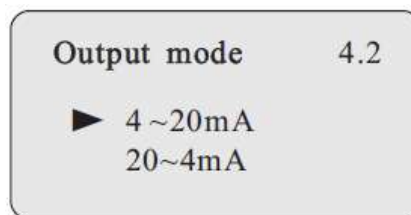

5.3.2.5.1 Output Mode

- Select output current as 4 to 20mA or 20 to 4mA.
- 4 to 20mA mean the minimum level is corresponding to 4mA and the maximum level is corresponding to 20mA.
- 20-4mA mean the minimum level is corresponding to 20mA and the maximum level is corresponding to 4mA.
- When the arrow points at output mode, press **OK** to get.





- Press **OK** to select menu.
- Press **OK** to confirm.

5.3.2.5.2 Failure Mode

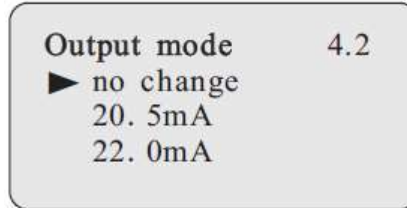

- Setup the output current on sensor error.
- When the arrow points at output mode, press  to get failure mode menu.
- Press  to confirm.

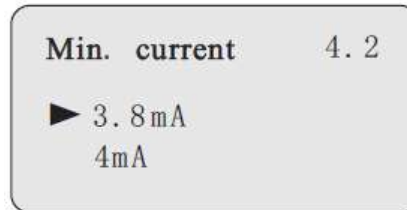

5.3.2.5.3 Minimum Current

- Setup the minimal output current is 4mA or 3.8mA.
- When the arrow points at fail mode, press  to get minimum current menu.
- Press  to confirm.





- Press  to select menu.
- Press  to confirm.

5.3.2.5.4 Reset

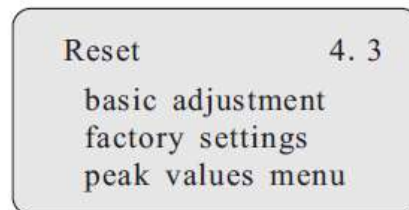
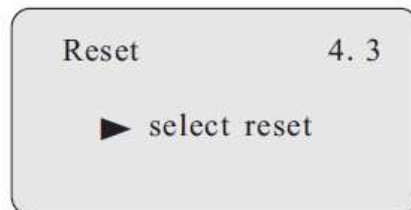
- Basic settings: Reset settings modified with view point to the default values.
- Factory settings: Reset special settings as well as basic settings to default values.
- Peak measured values: Reset the minimum or maximum level records.



- Press  to select menu.
- Press  to confirm.

5.3.2.5.5 Unit of Measure

- Two sets of measure system units are available. The metric system and the British system.

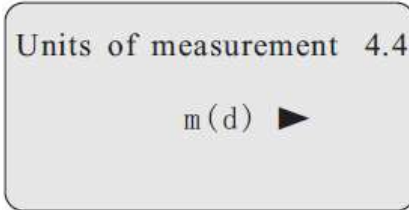

- Press **OK** to edit it.

5.3.2.5.6 Language

- You can change the language using this menu.
- English and Chinese are available.

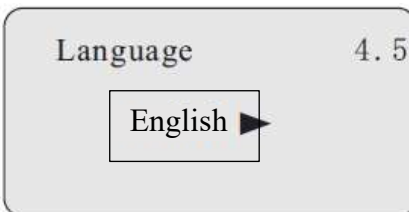

- Press **OK** to change it.

5.3.2.5.7 HART Operation Mode

- HART offers standard and multidrop mode.
- The standard mode with the fixed address 0 means output of the measured value as 4 to 20 mA signal. In multidrop mode, up to 15 sensors can be operated on one two-wire cable.
- In this menu you determine the HART mode and enter the address for multidrop.

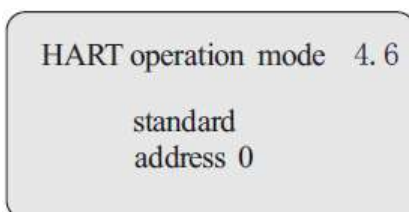

- Press **OK** to select HART operation mode.

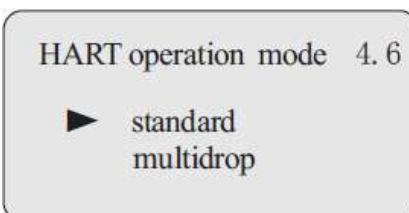

- The default setting is standard mode with address 0.

5.3.2.6 Copy Sensor Data

- In this menu you can back up the sensor settings to restore them when necessary.

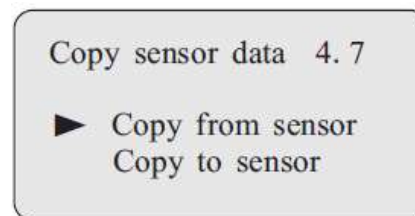
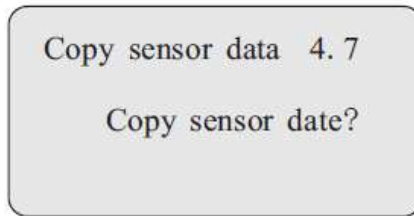

- Copy from sensor means to save the sensor settings and copy to sensor means to restore the sensor settings.

5.3.2.7 PIN

- In this menu, the PIN is activated or inactivated permanently.
- Entering a 4-digit PIN to protect the sensor data against unauthorized access and unintentional modifications.

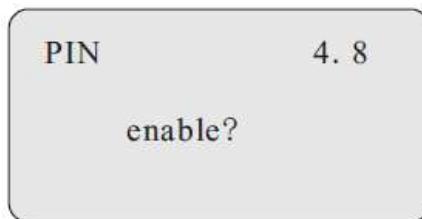

or

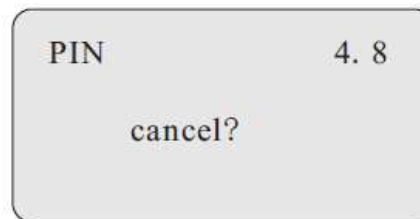

5.3.2.8 Distance Adjustments

- Distance adjustments is used to correct the difference between the measured value and actual distance.
- Press  to enter Distance Adjustments.

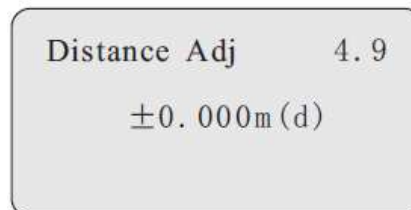

5.3.2.8.1 Threshold Setting

- Threshold setting is used to set the significant size of the echo threshold.
- The threshold set higher to respond effectively to fluctuations in Degree, which excludes the small-signal clutter.

*Note: If you modify the threshold value is greater than the effective echo amplitude, the wave will cause misunderstanding. The menu includes the echo threshold and amplitude envelope, which is the default rate of return threshold for the 60mV, amplitude envelope default value of 10mV.

5.3.2.9 Info

- In this menu the most important sensor information can be displayed:
 - Sensor type
 - Serial number: 6-digit number
 - Date of manufacture
 - Software version

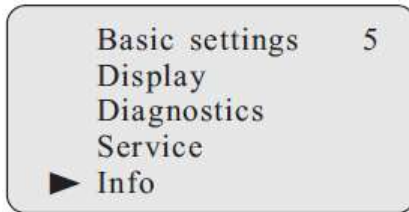

- Press  to enter the Info display menu.

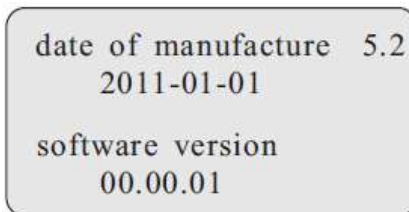
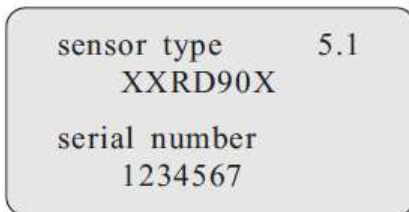

6 Menu Tree

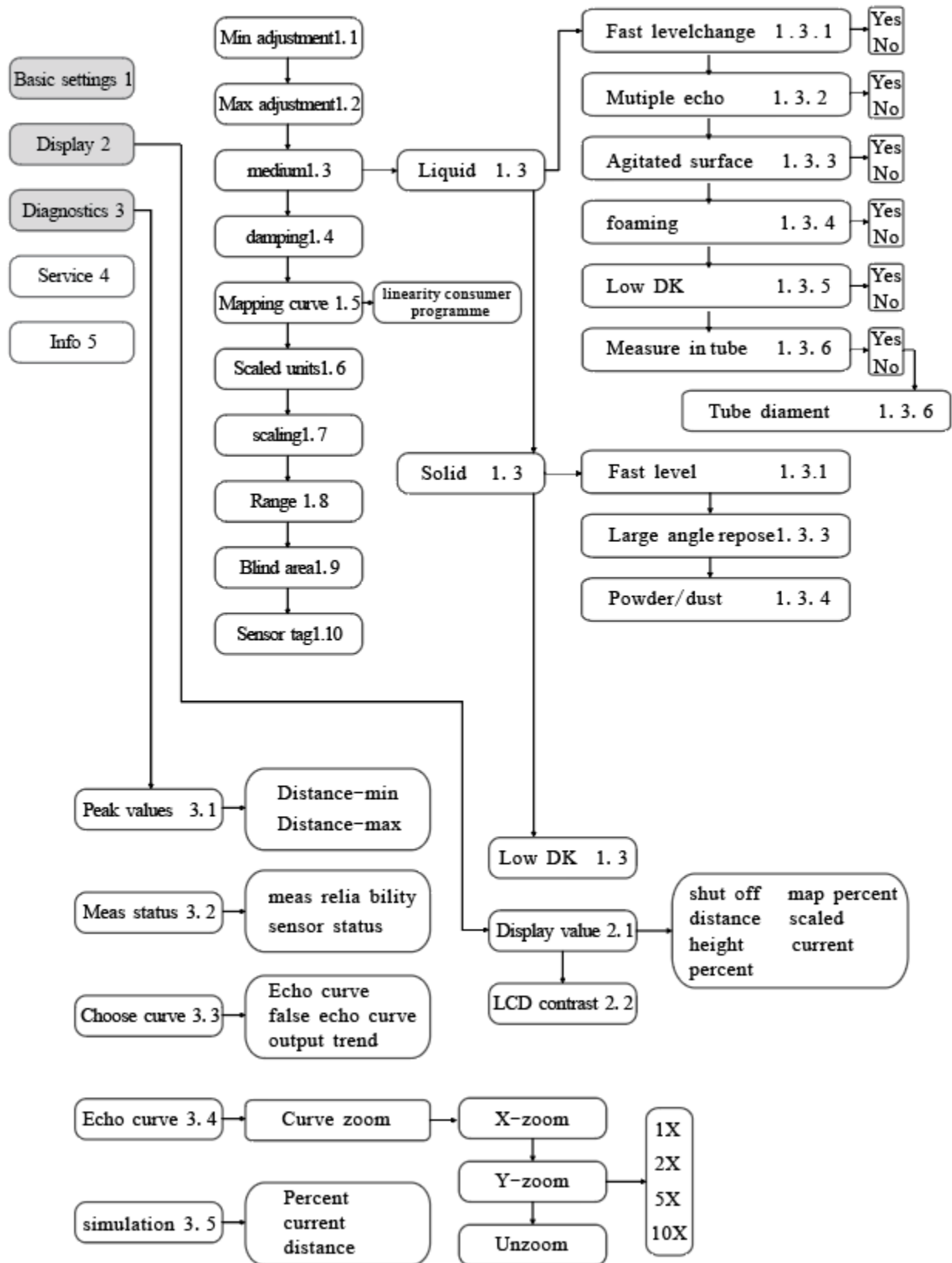

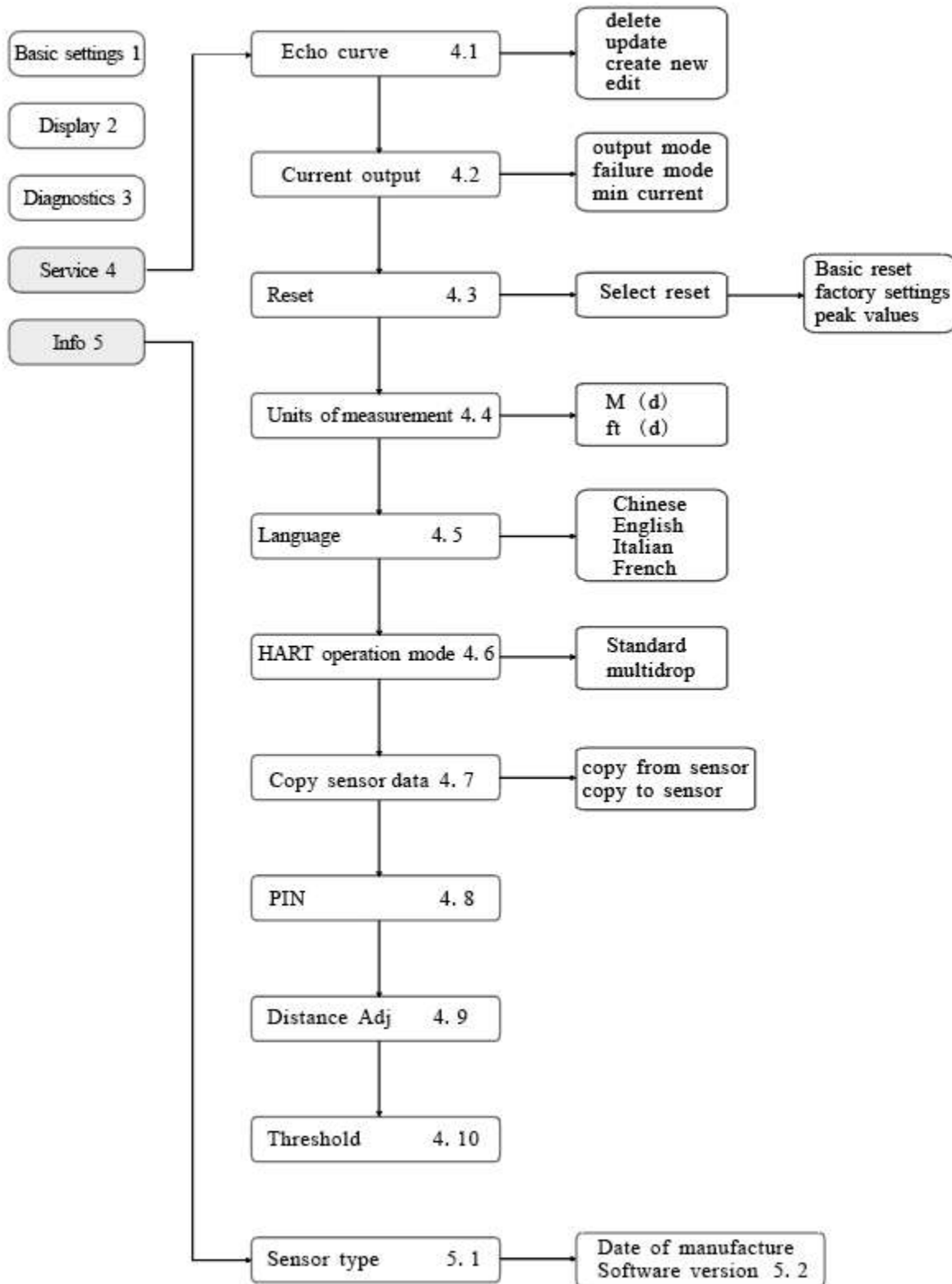



TEKMATION LLC reserves the right to change the designs and/or materials of its products without notice. The contents of this publication are the property of TEKMATON and cannot be reproduced by any other party without written permission. All rights reserved. Copyright © 2022 TEKMATON LLC
DOC/TEK/ITPS/MNL/22/05 12/4310C/004
TEKMATION LLC



www.tek-trol.com

Tek-Trol LLC

796 Tek Drive Crystal Lake, IL 60014, USA
Sales: +1 847-857-6076

Tek-Dpro Flow Solutions

PO Box 121 Windsor, Colorado 80550,
USA
Sales: +1 847-857-6076

Tek-Trol Solutions BV

Florijnstraat 18, 4879 AH Etten-Leur,
Netherlands
Sales: +31 76-2031908

Tek-Trol Middle East FZE

SAIF Zone, Y1-067, PO BOX No.
21125, Sharjah, UAE
Sales: +971-6526-8344

Support: +1 847-857-6076

Email: tektrol@tek-trol.com

www.tek-trol.com

Tek-Trol is a fully owned subsidiary of TEKMATON LLC. We offer our customers a comprehensive range of products and solutions for process, power and oil & gas industries. Tek-Trol provides process measurement and control products for Flow, Level, Temperature & Pressure Measurement, Control Valves & Analyzer systems. We are present in 15 locations globally and are known for our knowledge, innovative solutions, reliable products and global presence.

Flow | Level | Temperature | Pressure | Valves | Analyzers | Accessories | TekValSys