



CONTENTS

Scope of This Manual	5
Typographic Conventions	5
Unpacking and Inspection	5
Safety	5
Terminology and Symbols	5
Considerations	5
Introduction.	6
Dimensions	6
Remote Enclosure	6
Wall Mount Bracket	7
Panel Mount Enclosure	7
Operation	8
Keypad Operation on the Home Screen	8
Keypad Operation in the Menu Structure	8
Selecting an Option in a Parameter Selection List	9
Entering a Number	9
Installation.	10
Overview	10
Installation Considerations	10
Equipment Required	10
Installing the Transducers	10
Installing a Meter with a Remote Transmitter and Fixed Transducers	11
Installing a Meter with a Remote Transmitter and Adjustable Transducers	12
Installing a Panel-Mount Meter	13
Wiring the Transmitter	14
Torque Requirements	14
Electrical Symbols	14
Connection Data	14
Rated Conditions of Terminals	15
Wiring the Transducer.	15
Power	16
9...28V DC Power	16
20...26V AC Power.	16
Mains Power.	17
4...20 mA Output Wiring.	17
Digital Outputs Wiring	18
Digital Input Wiring	19
AquaCUE/BEACON Endpoint Wiring.	19

RTD Interface Wiring (Energy Models Only)	19
Auxiliary Output Card Wiring	20
Installing the MicroSD Card	20
Connecting the USB Cable	21
Initial Meter Setup	21
Menu Map	22
Parameter Descriptions by Menu	23
Main Menu Structure	23
Setup > Units	23
Setup > Meter	25
Setup > Meter > Pipe	26
Setup > Meter > Fluid	27
Setup > Meter > Spacing	27
Setup > Meter > Flow Setup	27
Setup > Meter > Advanced	28
Setup > Meter > Calibration	31
Setup > Input/Output > Current #1 (or Current #2)	32
Setup > Inputs/Output > Output #1 (or Output #2 or Output #3)	33
Setup > Inputs/Output > Aux Output #1 (or Aux Output #2)	36
Setup > Inputs/Output > Input	37
Setup > Inputs/Output > RTD (Energy Models Only)	37
Setup > Communications	38
Setup > Data Logging (Service Level Access)	41
Setup > Options	41
Setup > Passcode Setup > Security	42
Setup > Passcode Setup > Passcode Recovery	42
Display Menu	43
Information Menu	43
Diagnostics Menu	44
Reset Menu	45
Troubleshooting	46
Out of Specification Messages	46
Error Messages	46
Check Function Codes	46
Warning and Alarm Message Codes	46
Symptoms	48
Replacement Procedures	50
Replacing an AC Module	50
Replacing the Communication or Dry Contact Board	51
Replacing the Main Board	51

Firmware Update.	52
Specifications.	52
System	52
Transmitter	53
Transducers	54
RTD Kits.	54
SoloCUE Flow Device Manager Software.	54
Part Number Construction.	55
TFX-5000 Flow Meters for Pipes 2 in. and Smaller	55
TFX-5000 Flow Meters for Pipes 2 in. and Smaller for Class I, Div 2 Hazardous Locations.	56
TFX-5000 Flow Meters for Pipes 2.5 in. and Larger	57
TFX-5000 Flow Meters for Pipes 2.5 in. and Larger for U.S./Canada Hazardous Locations	58
TFX-5000 Flow Meters for Pipes Larger than 2 in. for ATEX/IECEx Hazardous Locations	59
TFX-5000 Energy Meters for Pipes 2 in. and Smaller	59
TFX-5000 Energy Meters for Pipes 2.5 in. and Larger	61
North American Pipe Schedules	62

SCOPE OF THIS MANUAL

This manual is intended to help you get the TFX-5000 meter up and running quickly. Read this manual carefully before attempting any installation or operation. Keep the manual accessible for future reference.

Typographic Conventions

- In step-by-step instructions, **bold** text indicates items on the screen you need to select or act upon.
Example: Click the **Setup** menu.
- Names of parameters, options, boxes, columns and fields are *italicized*.
Example: The value displays in the *Status* field.
- Messages and special markings are shown in quotation marks.
Example: "Error" displays in the title bar.
- In most cases, software screen text appears in the manual as it does on the screen. For example, if a word is capitalized on the screen, it is capitalized when referred to in the manual.

UNPACKING AND INSPECTION

Upon opening the shipping container, visually inspect the product and applicable accessories for any physical damage such as scratches, loose or broken parts, or any other sign of damage that may have occurred during shipment.

NOTE: If damage is found, request an inspection by the carrier's agent within 48 hours of delivery and file a claim with the carrier. A claim for equipment damage in transit is the sole responsibility of the purchaser.

SAFETY

Terminology and Symbols



Indicates a hazardous situation, which, if not avoided, *will* result in death or serious personal injury.



Indicates a hazardous situation, which, if not avoided, *could* result in death or serious personal injury.



Indicates a hazardous situation, which, if not avoided, *could* result in minor or moderate personal injury or damage to property.

Considerations

- The installation of the TFX-5000 meter must comply with all applicable federal, state, and local rules, regulations, and codes.
- Do not use sharp objects when operating the device (such as using a pen to press buttons on the keypad).
- When the TFX-5000 meter is a part of a system, it is configured in a fail-safe operation so that if the transmitter signal is compromised, the TFX-5000 meter will not cause harm to the system.

IMPORTANT

Not following instructions properly may impair safety of equipment and/or personnel.



AFTER DE-ENERGIZING, DELAY 5 MINUTES BEFORE OPENING.

INTRODUCTION

⚠ WARNING

THIS EQUIPMENT INCLUDES SOME EXTERNAL NON-METALLIC PARTS. THE USER SHALL THEREFORE ENSURE THAT THE EQUIPMENT IS NOT INSTALLED IN A LOCATION WHERE IT MAY BE SUBJECTED TO EXTERNAL CONDITIONS (SUCH AS HIGH-PRESSURE STEAM) WHICH MIGHT CAUSE A BUILD-UP OF ELECTROSTATIC CHARGES ON NON-CONDUCTING SURFACES. ADDITIONALLY, CLEANING OF THE EQUIPMENT SHOULD BE DONE ONLY WITH A DAMP CLOTH.

The TFX-5000 transit time meter measures volumetric flow and heating/cooling energy rates in clean liquids as well as those with small amounts of suspended solids or aeration, such as surface water or sewage. TFX-5000 ultrasonic flow and energy meters clamp onto the outside of pipes and do not contact the internal liquid.

The TFX-5000 meter is available in two versions:

- A flow meter for water delivery, sewage, cooling water, alcohols, chemical
- A heating/cooling energy flow meter used in conjunction with dual clamp-on RTDs for temperature measurement—ideal for hydronic process and HVAC applications

Transit time flow meters measure the time difference between the travel time of an ultrasound wave going *with* the fluid flow and *against* the fluid flow. The time difference is used to calculate the velocity of the fluid traveling in a closed-pipe system. The transducers used in transit time measurements operate alternately as transmitters and receivers. Transit time measurements are bi-directional and are most effective for fluids that have low concentrations of suspended solids and are sonically conductive.

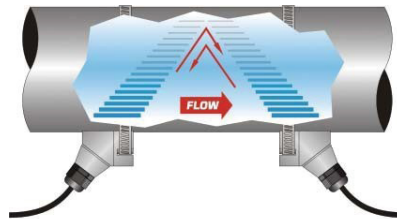

Figure 1: Meter operation

An ultrasonic meter equipped with heat flow capabilities measures the rate and quantity of heat delivered or removed from devices such as heat exchangers. By measuring the volumetric flow rate of the heat exchanger liquid, the temperature at the inlet pipe and the temperature at the outlet pipe, the energy usage can be calculated.

By applying a scaling factor, this heat flow measurement can be expressed in various units (Btu, Watts, Joules, Kilowatts and others).

DIMENSIONS

NOTE: Installation instructions begin on [page 10](#).

Remote Enclosure

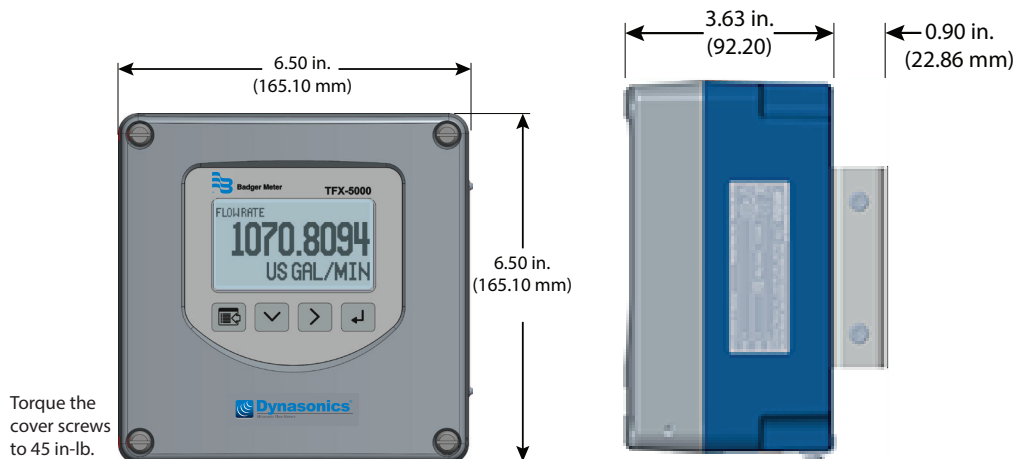

Figure 2: Remote mount enclosure dimensions

Wall Mount Bracket

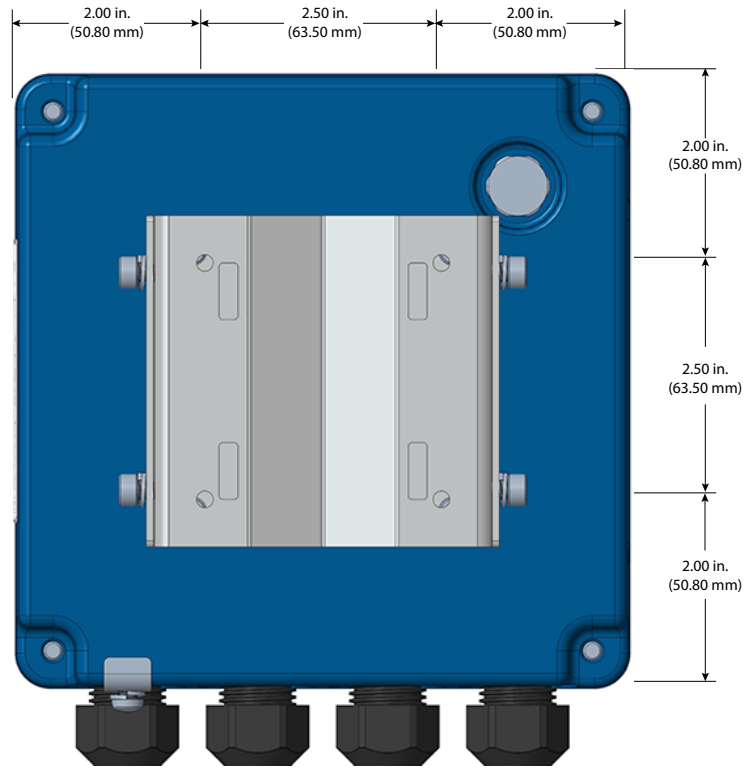

Figure 3: Wall mount enclosure dimensions

Panel Mount Enclosure

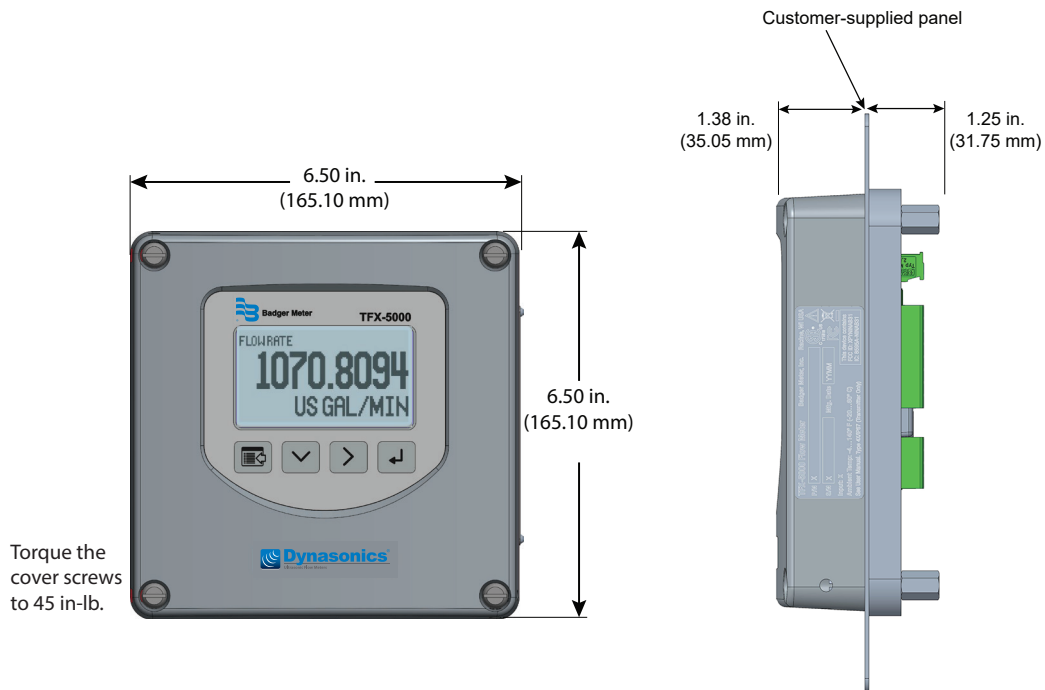





Figure 4: Panel mount enclosure dimensions

OPERATION

Keypad Operation on the Home Screen



-  The *MENU/BACK* key enters menu structure.
-  The *DOWN ARROW* key toggles between flow rate, flow total, velocity and flow rate with flow total.
-  The *RIGHT ARROW* key has no function.
-  The *ENTER* key has no function.

Keypad Operation in the Menu Structure



The cursor bar highlights the submenu or parameter that will be viewed or edited. The scroll bar on the right indicates the relative position the cursor bar is at on the list when there are more than 4 items.

- *MENU/BACK* returns to parent menu (up a level). If at the *Main* (top level) menu, returns to the *Home Screen*.
- *DOWN ARROW* scrolls the list.
- *RIGHT ARROW* and *ENTER* have the same function in the menu structure and advance to the submenu or to read/edit a parameter.

Selecting an Option in a Parameter Selection List

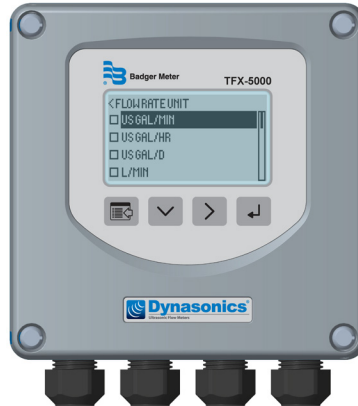

The active option in the parameter list has a filled-in box on the left side. The scroll bar on the right indicates the relative position the cursor bar is at on the list when there are more than 4 items.

- *DOWN ARROW* scrolls the list.
- *ENTER* selects the option and the box on the left side fills in to show the item is selected.
- *MENU/BACK* exits parameter editing and returns to the parent menu (up a level).

Entering a Number



The parameter name and current value is displayed in the top portion of the screen. Edit the number on the bottom right of the screen.

- *MENU/BACK* exits parameter editing and returns to parent menu (up a level). The parameter remains at the value displayed in the top portion of the screen.
- *DOWN ARROW* cycles through the numbers and other options.
- *RIGHT ARROW* moves the cursor to the right. Once it reaches the rightmost digit or a space, the cursor moves to the leftmost digit.
- *ENTER* accepts the value.

INSTALLATION

Overview

Each of the installation steps that follow is explained in detail on [page 11](#) through [page 12](#). The actual installation procedures differ slightly, depending on whether the transducers are *fixed* or *adjustable*.

If the transducers are *fixed*, you will:

1. Install the transducers.
2. Install the transmitter.
3. Wire the transmitter.
4. Program the meter.

If the transducers are *adjustable*, you will:

1. Install the transmitter.
2. Wire the transmitter.
3. Set up the meter (select the optimum transmission mode, enter the site information, and enter the fluid and pipe properties).
4. Install the transducers.
5. Complete the meter programming.

Installation Considerations

Mount the transmitter in a location:

- Where little vibration exists.
- That is protected from corrosive fluids.
- That is within the transmitters ambient temperature limits:
–4...140° F (–20...60° C); relative humidity 0...85%, non-condensing; altitude 2000 m max.
- That is out of direct sunlight. Direct sunlight may increase transmitter temperature above the maximum limit.
- That protects the oleophobic vent from materials that may plug or seal the vent.

Equipment Required

- Screwdrivers, wide blade and tiny blade (for securing wires to the terminal blocks)
- User manual for the transducers
- Four #8 or M4 screws, if mounting the transmitter on a wall
- Stainless steel banding straps, if mounting the transmitter on a pipe

Installing the Transducers

See the user manual for your particular transducer for installation instructions.

Installing a Meter with a Remote Transmitter and Fixed Transducers

- Locate the transmitter within the length of the transducer cables supplied or exchange the cable for one of proper length.
- See [Figure 2 on page 6](#) for enclosure and mounting dimension details. Allow enough room for door swing, maintenance and conduit entrances.

IMPORTANT

When routing wires to the transmitter, make sure the cables are not twisted, pinched or hanging loosely.

1. Install the *fixed* transducers according to instructions in the transducer user manual.
2. Attach the mounting bracket to a wall (with 4 customer-supplied #8 or M4 screws, see [“Wall Mount Bracket” on page 7 for dimensions](#)) or to a pipe (with mounting straps).

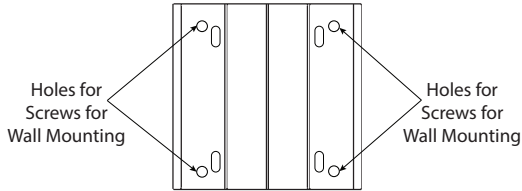

Figure 5: Wall mount

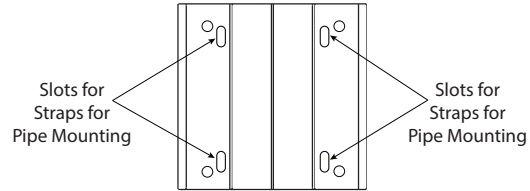

Figure 6: Pipe Mount

3. Align the transmitter's bracket with the mounted bracket. Use a 4 mm hex tool to secure the 4 provided screws from the sides through the mating holes. See [Figure 8](#).
4. If necessary, you can rotate the mounting bracket in 90° increments to accommodate the final orientation of the transmitter. From inside the enclosure, remove the 4 screws holding the bracket. Rotate the bracket and replace the screws. See [Figure 7](#).

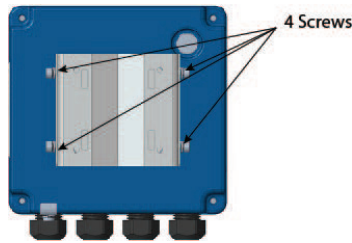

Figure 7: Rotatable adapter plate

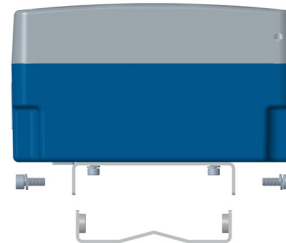

Figure 8: Secure the bracket

5. Insert a wire for earth ground under the grounding bracket (see [Figure 10](#)) and screw it down tight.
6. Partially loosen the 2 enclosure captive screws on the left side of the transmitter cover. Completely loosen the 2 screws on the right side. Grasp and lift the cover and open it to the left. The cover remains attached and the left screws act as a hinge.

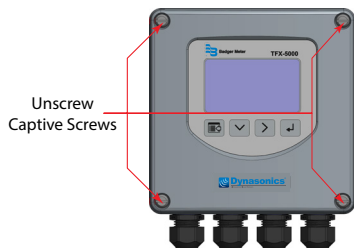

Figure 9: Captive cover screws

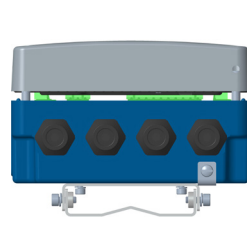

Figure 10: Lift cover from base

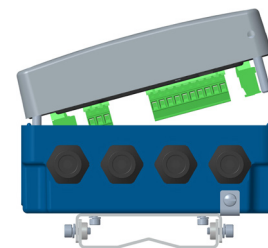

Figure 11: Open cover to the left

7. Use conduit holes where cables enter the enclosure from the bottom. Use suitably certified plugs to seal any holes that are not used for cable entry. A cable gland kit is included for inserting the transducer and power cables.

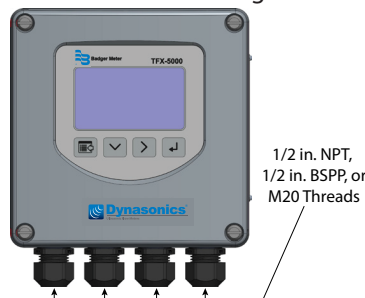

Figure 12: Conduit holes

NOTE: Use suitably certified fittings/plugs to maintain the watertight integrity of the enclosure. Generally, the right conduit hole (viewed from front) is used for power, the left conduit hole for transducer connections, and the center holes are used for I/O wiring.

8. Install the wires through the gland nuts and connect the wires to the removable terminal blocks. See [“Wiring the Transmitter” on page 14](#).
9. Wire the transducers to the transmitter.
10. Plug the wired terminal blocks into the main board.
11. Reassemble the cover. Torque the cover screws to 45 in-lb.
12. Set up the meter. See [“Initial Meter Setup” on page 21](#) for instructions.

Installing a Meter with a Remote Transmitter and Adjustable Transducers

- Locate the transmitter within the length of the transducer cables supplied or exchange the cable for one of proper length.
- Install the transducers after entering the pipe settings into the transmitter and determining the spacing and mounting method.
- See [Figure 2 on page 6](#) for enclosure and mounting dimension details. Allow enough room for door swing, maintenance and conduit entrances.

IMPORTANT

When routing wires to the transmitter, make sure the cables are not twisted, pinched or hanging loosely.

1. Attach the mounting bracket to a wall (with 4 customer-supplied #8 or M4 screws, see [“Wall Mount Bracket” on page 7](#) for dimensions) or to a pipe (with mounting straps).

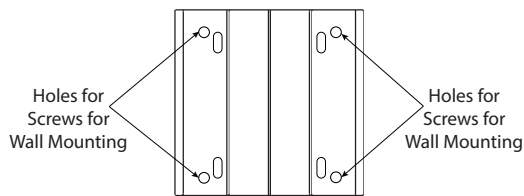

Figure 13: Wall mount

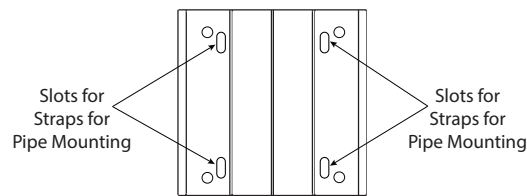

Figure 14: Pipe Mount

2. Align the transmitter's bracket with the mounted bracket. Use a 4 mm hex tool to secure the 4 provided screws from the sides through the mating holes. See [Figure 16](#).
3. If necessary, you can rotate the mounting bracket in 90° increments to accommodate the final orientation of the transmitter. From inside the enclosure, remove the 4 screws holding the bracket. Rotate the bracket and replace the screws. See [Figure 15](#).

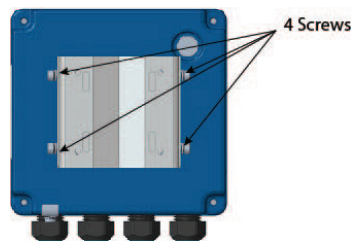

Figure 15: Rotatable adapter plate



Figure 16: Secure the bracket

4. Insert a wire for earth ground under the grounding bracket (see [Figure 18](#)) and screw it down tight.
5. Partially loosen the 2 enclosure captive screws on the left side of the transmitter cover. Completely loosen the 2 screws on the right side. Grasp and lift the cover and open it to the left. The cover remains attached and the left screws act as a hinge.

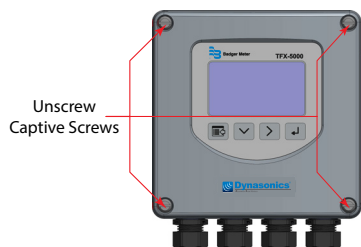

Figure 17: Captive cover screws

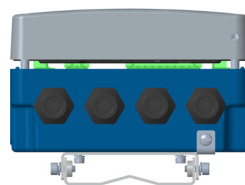

Figure 18: Lift cover from base

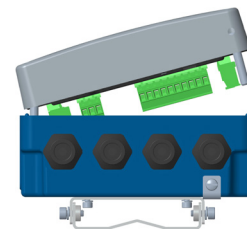
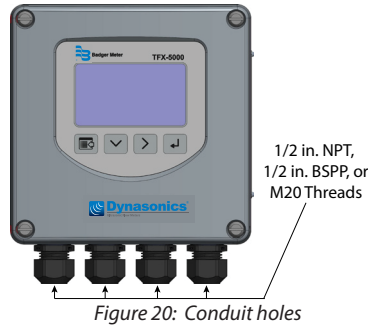

Figure 19: Open cover to the left

- Use conduit holes where cables enter the enclosure from the bottom. Use suitably certified plugs to seal any holes that are not used for cable entry. A cable gland kit is included for inserting the transducer and power cables.



NOTE: Use suitably certified fittings/plugs to maintain the watertight integrity of the enclosure. Generally, the right conduit hole (viewed from front) is used for power, the left conduit hole for transducer connections, and the center holes are used for I/O wiring.

- Install the wires through the gland nuts and connect the wires to the removable terminal blocks. See [“Wiring the Transmitter” on page 14](#).
- Set up the meter. See [“Initial Meter Setup” on page 21](#) for instructions.
- Install the *adjustable* transducers according to instructions in the transducer user manual.
- Wire the transducers to the transmitter.
- Plug the wired terminal blocks into the main board.
- Reassemble the cover. Torque the cover screws to 45 in-lb.

Installing a Panel-Mount Meter

- Measure and cut a mounting hole into the customer-supplied panel to the dimensions shown in [Figure 21](#).
- Remove the 4 screws and 4 O-rings holding the front of the unit to the frame.
- Verify that the gasket is secure in the mounting bezel.
- Guide the front of the unit through the panel cutout.
- Insert the 4 screws through the front of the unit and the panel.
- Apply one O-ring to each screw from the back of the panel.
- Align the front of the unit to the frame.
- Tighten the 4 screws and torque them to 45 in-lb.

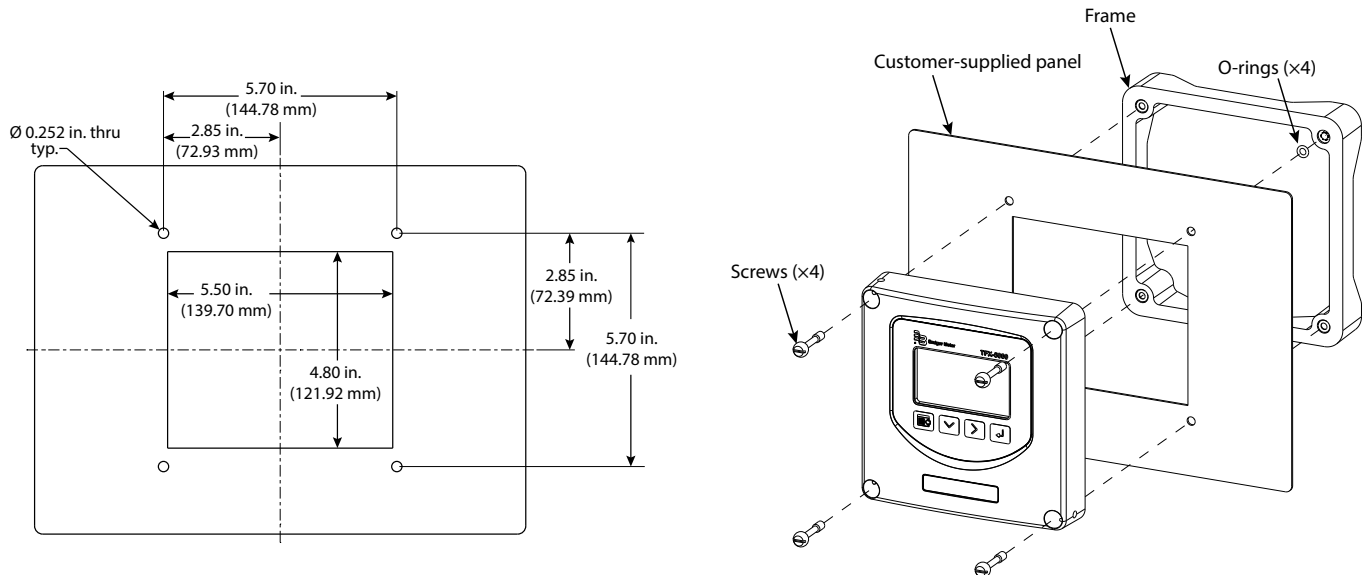

Figure 21: Panel cutout dimensions and installation exploded view

WIRING THE TRANSMITTER

IMPORTANT: Select field wiring means rated for 5° C above the maximum area temperature when it is possible that the temperature will exceed 55° C.

To access terminal strips for wiring, loosen the 4 enclosure captive screws. Grasp and lift the cover and open it to the left. The cover remains attached and the left screws act as a hinge.

Torque Requirements

The tightening torque requirements for the screw connections of the plug-in terminals are 4.4 lb-in. (0.5 Nm) minimum to 5.3 lb-in. (0.6 Nm) maximum.

Electrical Symbols

Function	Direct Current	Alternating Current	Earth (Ground)	Protective Ground	Chassis Ground
Symbol					

Figure 22: Electrical symbols

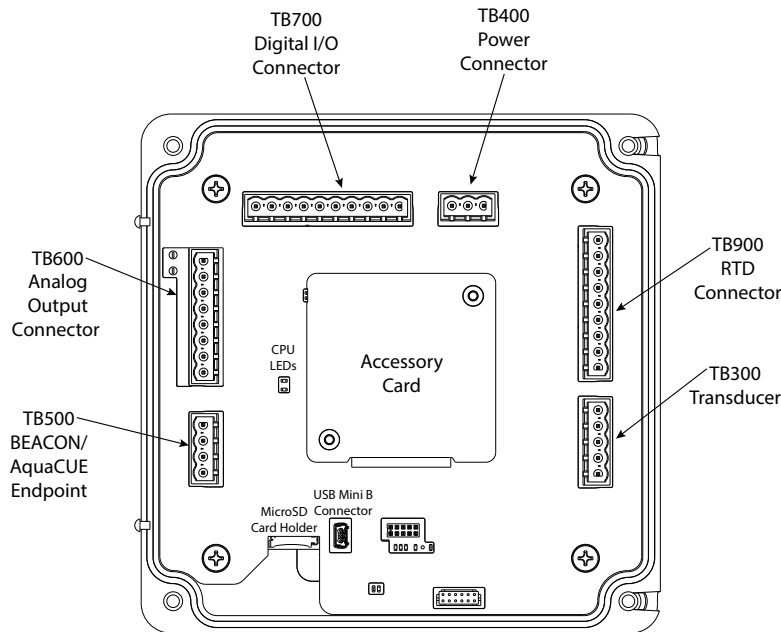

Figure 23: Wiring connectors

Connection Data

Description	Minimum	Maximum
Conductor cross section solid	0.2 mm ²	2.5 mm ²
Conductor cross section flexible	0.2 mm ²	2.5 mm ²
Conductor cross section flexible, with ferrule without plastic sleeve	0.25 mm ²	2.5 mm ²
Conductor cross section flexible, with ferrule with plastic sleeve	0.25 mm ²	2.5 mm ²
Conductor cross section AWG	24	12
2 conductors with same cross section, solid	0.2 mm ²	1 mm ²
2 conductors with same cross section, stranded	0.2 mm ²	1.5 mm ²
2 conductors with same cross section, stranded, ferrules without plastic sleeve	0.25 mm ²	1 mm ²
2 conductors with same cross section, stranded, TWIN ferrules with plastic sleeve	0.5 mm ²	1.5 mm ²
AWG according to UL/CUL	30	12

Rated Conditions of Terminals

- Mains AC 85...264V AC
Wire 18...12 AWG UL AWM 1007 Type 1007
- 9...28V DC, 20...26V AC
Wire 20 AWG UL AWM 1007 Type 1007
- Transducer Cables
Badger Meter supplied cable
- Digital Outputs/Inputs, Current Output, RS485, RTD or Encoder Interface
Wire 28...12 AWG UL AWM 1007 Type 1007

Wiring the Transducer

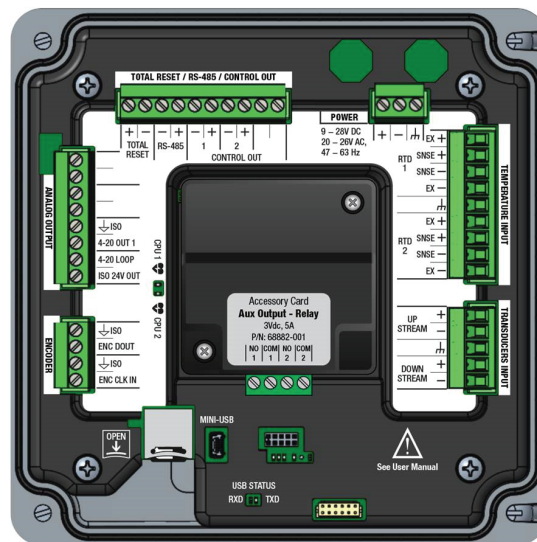

Figure 24: Wiring connections

NOTE: Submersible transducer cables are larger diameter. Each cable requires a separate conduit hole. The standard yellow cable and high temperature cables are small enough to use a single cable gland with a 2-hole grommet.

NOTE: Transducer cables have two wire-color combinations. For the blue and white combination, the blue wire is positive (+) and the white wire is negative (-). For the red and black combination, the red wire is positive (+) and the black wire is negative (-). The transducer wires are labeled to indicate which pair is upstream or downstream.

1. Guide the transducer terminations through a conduit hole in the bottom of the enclosure.
2. Secure the transducer cable with the supplied conduit nut (if flexible conduit was ordered with the transducer).
3. Install the ferrite to the cable:
 - a. To open the ferrite, pull the fastener away from the body of the ferrite.
 - b. Wrap the cable tightly around half of the ferrite and place the cable into the groove.
 - c. Snap the ferrite shut.



4. The terminals within the transmitter are screw-down barrier terminals. Connect the wires at the corresponding screw terminals in the transmitter. Observe upstream and downstream orientation and wire polarity. See [Figure 25](#).

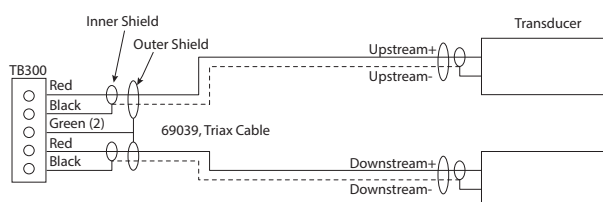

Figure 25: Upstream/downstream transducer

Power

Connect power to the screw terminal block in the transmitter.

- Low voltage power can use any available conduit hole in the enclosure.
- Line voltage AC power must use the right conduit hole, which is aligned with the terminal block on the AC power board.
- Use wiring practices that conform to local and national codes such as The National Electrical Code Handbook in the U.S.

⚠ CAUTION

ANY OTHER WIRING METHOD MAY BE UNSAFE OR CAUSE IMPROPER OPERATION OF THE TRANSMITTER.

NOTE: This transmitter requires clean electrical line power. Do not operate this transmitter on circuits with noisy components (such as fluorescent lights, relays, compressors, or variable frequency drives). Do not use step-down transformers from high voltage, high amperage sources. Do not to run signal wires with line power within the same wiring tray or conduit.

9...28V DC Power

The transmitter may be operated from a 9...28V DC source, as long as the source supplies a maximum of 8 Watts of power. Connect the DC power to 9...28V DC In, power return, and chassis ground, as in [Figure 26](#).

NOTE: DC-powered transmitters are protected from major catastrophe with an internal 2.0 Amp slow-blow fuse. If this fuse is blown, replace the transmitter or return it to the factory for repair.

IMPORTANT: A Class II DC power supply is required.

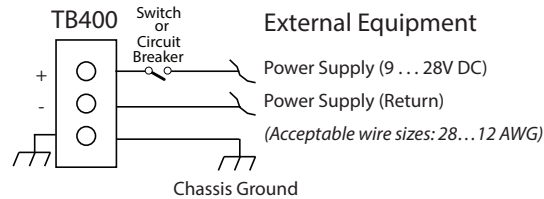

Figure 26: Power supply 9...28V DC

20...26V AC Power

The transmitter may be operated from a 20...26V AC source, as long as the source supplies a maximum of 8 Watts of power. Connect the AC power to 20...26V AC In, power return, and chassis ground, as in [Figure 27](#).

NOTE: 24V AC powered transmitters are protected from major catastrophe with an internal 2.0 Amp slow-blow fuse. If this fuse is blown, replace the transmitter or return it to the factory for repair.

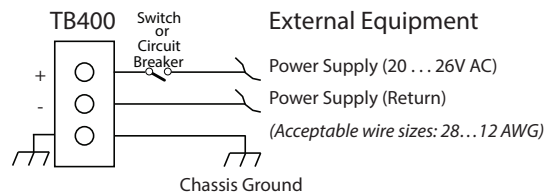

Figure 27: Power supply 20...28V AC

Mains Power

IMPORTANT

The measuring device does not have an internal circuit breaker. For compliance with IEC 61010-1, a switch in close proximity to the transmitter is required so that the power supply line can be easily disconnected from the mains.

The transmitter may be operated from 90...250V AC, 47...63 Hz, 24VA maximum power source.

NOTE: Mains AC-powered transmitters are protected with 1A, 250V AC, 5×20 mm, slow-blow, field-replaceable fuse.

⚠ WARNING

TO PREVENT SHORTING OUT THE MAINS AC POWER, YOU MUST REPLACE THE TERMINAL BLOCK COVER ON THE AC MODULE AFTER WIRING THE POWER.

Remove the terminal block covers before wiring and replace them after wiring:

1. Grasp the sides of the cover and gently pull it up.
2. Insert wires into the slots on the cover and screw them down to secure.
3. Align the cover in its original orientation over the terminal block and push down to connect.

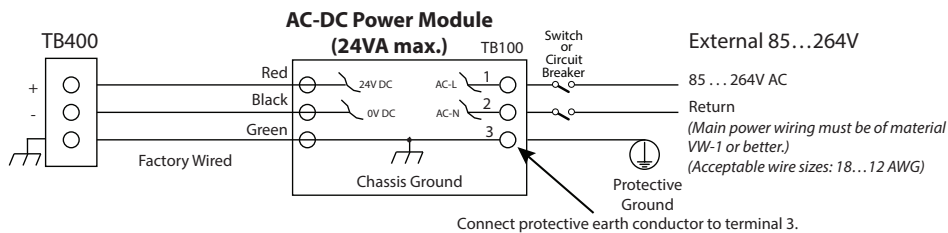

Figure 28: AC/DC power connections

4...20 mA Output Wiring

Set up the current range and scaling in the *Setup > Input/Output > Current #1 (or Current #2)* menu. See "*Setup > Input/Output > Current #1 (or Current #2)*" on page 32 for details.

The 4...20 mA output transmits an analog current signal that is proportional to system flow rate. The 4...20 mA output can be internally or externally powered and can span negative to positive flow rates.

Both current loops are ISOLATED from DC GND or Power.

For ambient temperature above 95° F (35° C), do not use more than 2 current outputs and do not exceed 46 mA.

NOTE: 4...20 OUT 2 available with Energy model only.

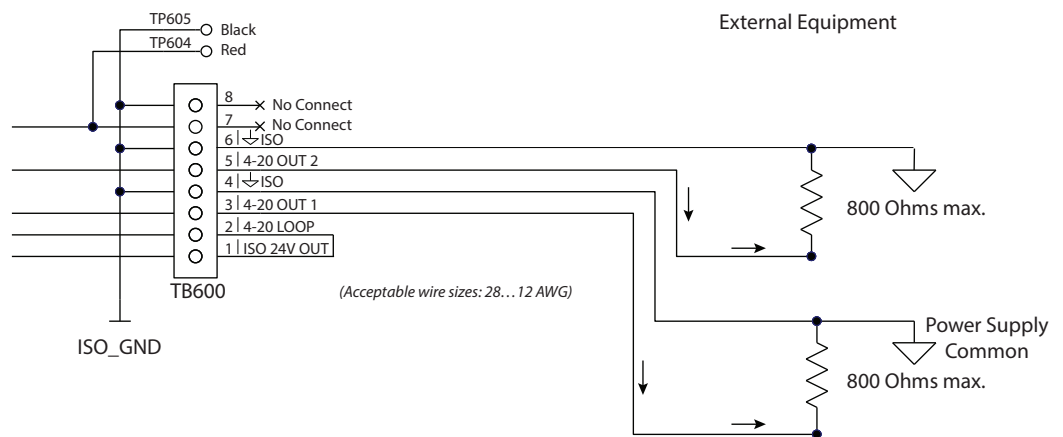

Figure 29: Typical 4...20 mA interface using internal isolated 24V DC source

NOTE: 4...20 OUT 2 available with Energy model only.

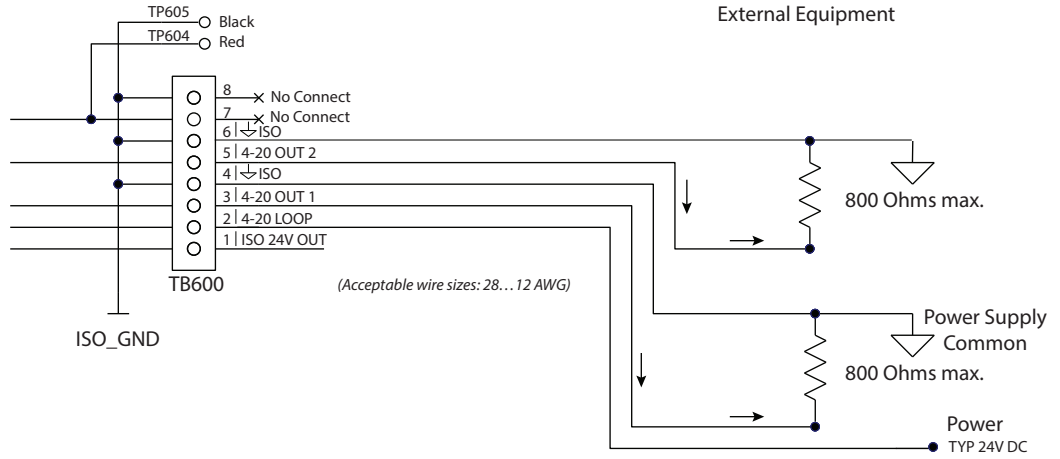

Figure 30: Typical 4...20 mA interface using external isolated 24V DC source

Digital Outputs Wiring

NOTE: Control Output 3 available with Energy model only.

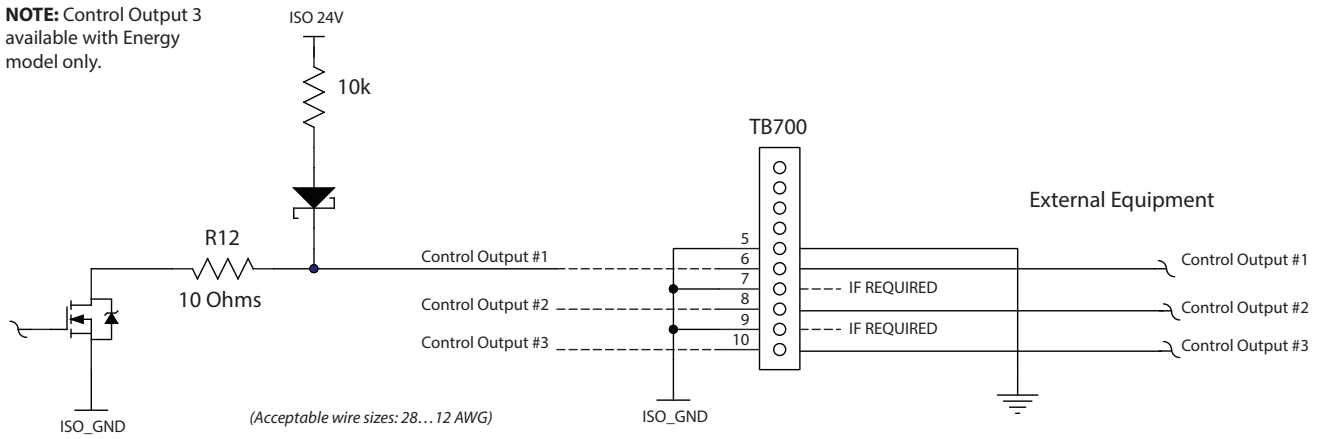

Figure 31: Typical control out 1, 2 and 3 interface with internal pullups active

NOTE: Control Output 3 available with Energy model only.

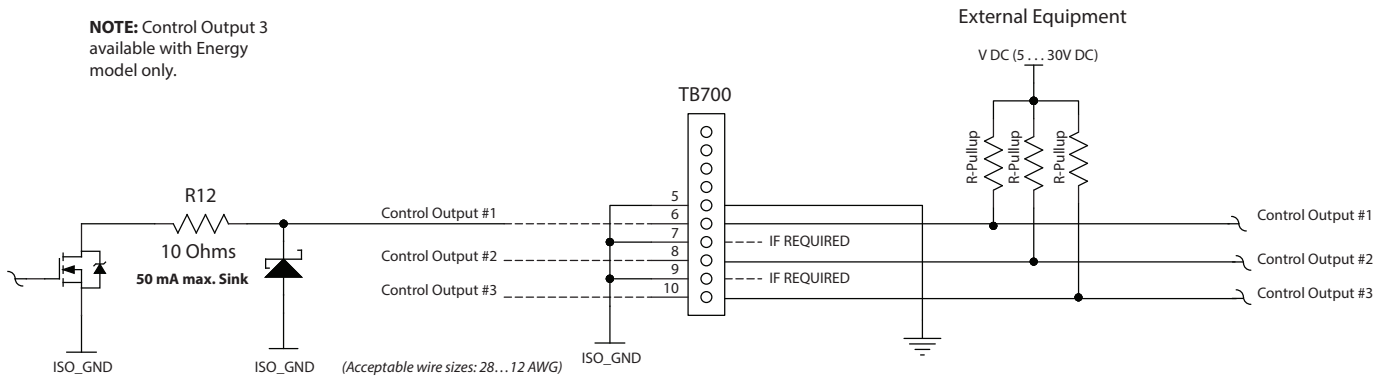

Figure 32: Typical control out 1, 2 and 3 interface with external pullups passive

RS485 Output

The RS485 feature allows up to 126 transmitters to be placed on a single three-wire cable up to 4000 feet. All transmitters are assigned a unique numeric address that allows all of the transmitters on the cable network to be independently accessed. Either Modbus RTU or BACnet MS/TP protocol is used to interrogate the transmitters.

Flow rate and total can be monitored over the digital communications bus.

When a USB programming cable is connected, the RS485 and frequency outputs are disabled.

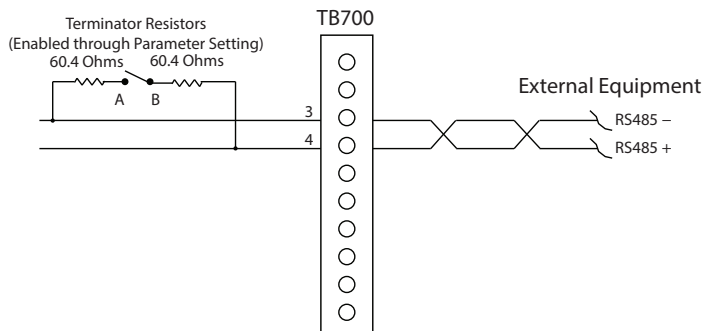

Figure 33: Typical RS485 interface

Digital Input Wiring

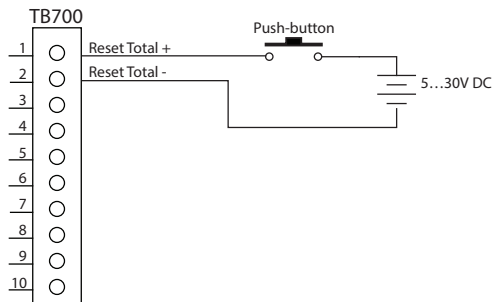
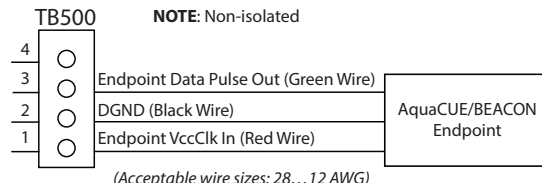

Figure 34: Digital input—reset totalizer

AquaCUE/BEACON Endpoint Wiring



(Acceptable wire sizes: 28...12 AWG)

Figure 35: AquaCUE/BEACON wiring

RTD Interface Wiring (Energy Models Only)

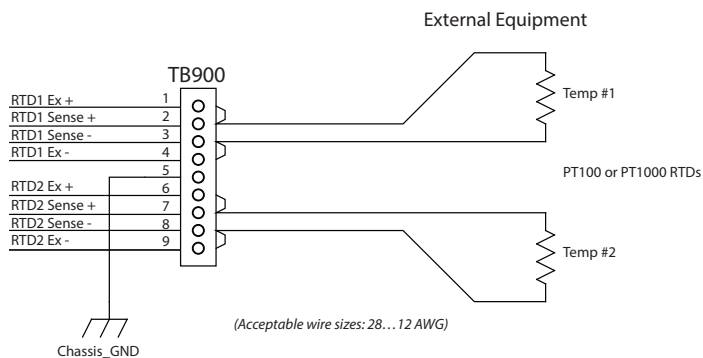

(Acceptable wire sizes: 28...12 AWG)

Figure 36: Two-wire RTD interface

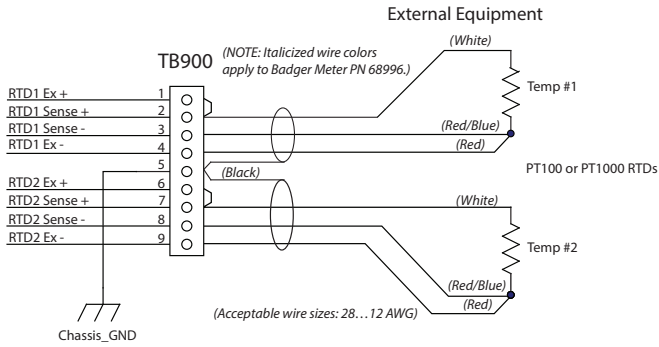

Figure 37: Three-wire RTD interface

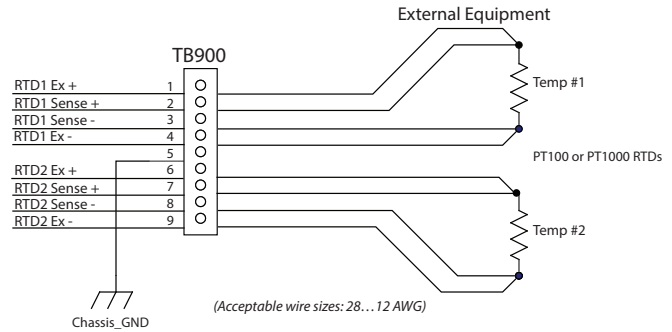

Figure 38: Four-wire RTD interface

Auxiliary Output Card Wiring

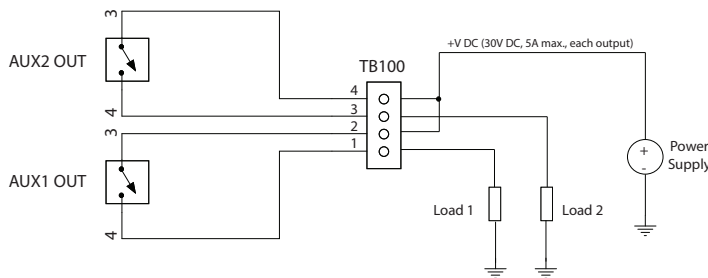

Figure 39: Auxiliary output interface

Installing the MicroSD Card

⚠ WARNING

IN A HAZARDOUS LOCATION WHERE EXPLOSIVE GAS OR DUST IS PRESENT, DISCONNECT THE POWER BEFORE OPENING THE ENCLOSURE AND INSERTING OR REMOVING THE MICROSD CARD. AFTER THE CARD IS INSERTED OR REMOVED, CLOSE THE ENCLOSURE BEFORE REAPPLYING POWER.

1. In all locations, turn off power to the unit.
2. Remove the enclosure cover.
3. Put your finger in the groove of the tray and slide the tray downward. The tray springs open.

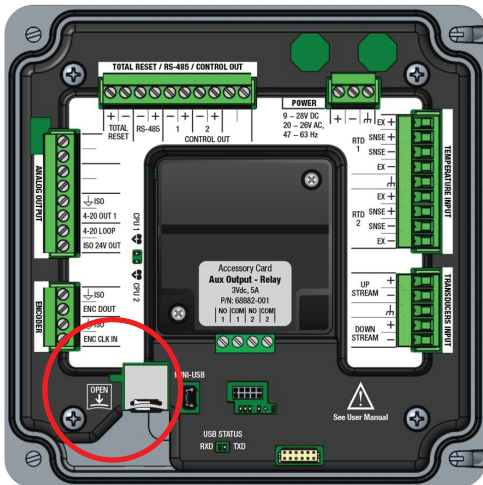

4. Insert the MicroSD card.
5. Slide the cover up to close.
6. Replace the enclosure cover.

Connecting the USB Cable

Use a USB cable when connecting a TFX-5000 meter to a computer with SoloCUE® Flow Device Manager software.

WARNING

DO NOT USE THE MINI USB PORT IN A HAZARDOUS LOCATION WHERE EXPLOSIVE GAS OR DUST IS PRESENT. DO NOT OPEN THE TRANSMITTER WHILE POWERED IF WATER OR SPRAY COULD CONTACT ELECTRONICS OR INTERIOR.

1. Open the enclosure cover.
2. Connect the USB cable to the mini USB port, aligning the pins in the cable with the holes in the port.
3. Program the transmitter.
4. Remove the USB cable and close the enclosure cover.

Initial Meter Setup

You can set up the meter using the TFX-5000 keypad or the SoloCUE Flow Device Manager software. This document addresses procedures using the TFX-5000 keypad. To use SoloCUE, see the "SoloCUE Flow Device Manager Installation Guide" available at www.badgermeter.com.

For in-depth parameter programming, see "[Parameter Descriptions by Menu](#)" on page 23.

1. Program the meter settings:
When using the keypad to set up the TFX-5000 meter to measure flow, press **MENU/BACK** to enter the main menu. In the *SETUP > METER* menu:
 - a. Enter the pipe characteristics, transducer, mounting and fluid.
 - b. Record the calculated spacing as needed.
 - c. Install transducer. See the transducer user manual for instructions.
2. Check calibration:
In the *SETUP > METER > CALIBRATION* menu, select **Field** for the *Factor Mode* if firmware version is prior to 02.02.480. Enter the calibration and sensor factors from the transducers into the scale factor and sensor factor value.
3. Zero the meter:
Due to different pipe characteristics, the meter must be zeroed in order to maintain accuracy. The recommended method is to stop flow and make sure there is no flow before zeroing the meter. In situations in which that is not feasible, you may zero the meter while the flow is steady or enter the zero manually. Based on *ZERO MODE*, the *SET ZERO* option will be selectable.
 - d. If *ZERO MODE* is set to *NO FLOW*:
Check that the pipe is full of liquid and not flowing. Flow must be absolutely zero.
Securely close any valves and allow time for settling to occur.
Select **SET ZERO-NO FLOW** and click **OK** to set the new zero.
 - e. If *ZERO MODE* is set to *STEADY FLOW*:
Check that the pipe is full of liquid and flowing at a steady rate.
Select **SET ZERO-FLOW** and click **OK** to set the new zero.
4. Select temperature sensor (energy models only):
In the *SETUP > INPUTS/OUTPUT > RTD* menu, select the temperature sensor type, range and order for positive and negative energy calculations.
5. Select units:
In the *SETUP > UNITS* menu, select the units and format of flow rate, total and velocity, and for energy meters the energy rate, energy total and temperature.
6. Set up the flow settings:
In the *SETUP > METER > FLOW SETUP* menu, select flow direction, low and maximum flow cutoff, and minimum and maximum signal strength.

MENU MAP

NOTE: Passcode levels for *write access* to each menu are as follows:
(O) = Operator, Service or Admin
(S) = Service or Admin
(A) = Admin
 If no passcode is entered, all parameters can still be *read*.

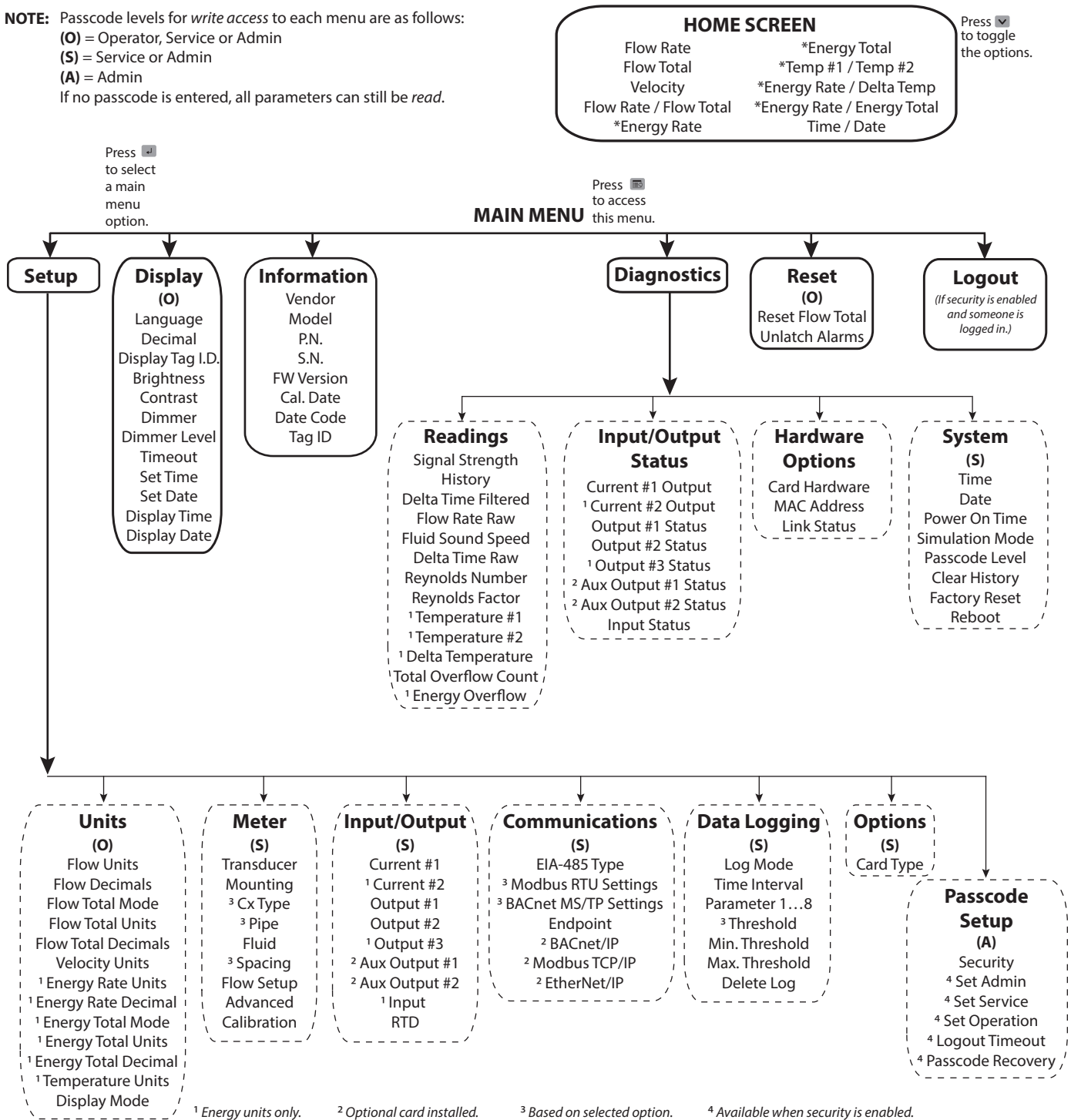

PARAMETER DESCRIPTIONS BY MENU

Main Menu Structure

The transmitter's firmware has a hierarchical menu structure. See "[Menu Map](#)" on page 22 for a visual path to the parameters. The five *Main Menus* used in the transmitter firmware are as follows:

Menu	Function
SETUP	Contains all of the configuration parameters for initially programming the transmitter to measure flow
DISPLAY	Configures transmitter display functions
INFORMATION	Displays system information, such as the model number and firmware version
DIAGNOSTICS	Displays system status and allows you to clear the history, reset to factory defaults and reboot the system
RESET	Resets the flow total or unlatches alarms

The following pages define the configuration parameters located in each of the menus.

Setup > Units

Use *SETUP > UNITS* to define the measurement standards for the transmitter. Contains all of the configuration parameters for setting the units and decimals for the readings and the totalizer mode. Requires operator level passcode or higher if security is enabled.

An asterisk (*) indicates the parameter default.

Units Submenus	Options/Descriptions	
FLOW UNITS	Select the flow rate units/interval displayed on the <i>Home Screen</i> . <i>FLOW UNITS</i> are automatically converted into the selected option.	
	Option	Units/Interval
	Fluid BBL/D	Fluid Barrels/Day (31.5 Gal)
	IBBL/D	Imperial Fluid Barrels/Day (36 IG)
	L/S	Liters/Second
	L/MIN	Liters/Minute
	L/H	Liters/Hour
	M ³ /S	Cubic Meters/Second
	M ³ /MIN	Cubic Meters/Minute
	M ³ /H	Cubic Meters/Hour
	FT ³ /S	Cubic Feet/Minute
	FT ³ /MIN	Cubic Feet/Minute
	FT ³ /H	Cubic Feet/Hour
	Custom	This selection is only available if <i>Custom Units</i> is enabled through SoloCUE Flow Device Manager. Use SoloCUE to change the <i>Custom Units</i> .
FLOW DECIMALS	This is a numeric entry for the number of decimal places to display. Default is 2. Options are 0...7	
FLOW TOTAL MODE	*GROSS FLOW	Any flow in forward and reverse direction.
	FORWARD FLOW REVERSE FLOW NET FLOW	Forward flow minus reverse flow. A negative total results when reverse flow is greater than forward flow.

Units Submenus	Options/Descriptions																
FLOW TOTAL UNITS	Select the units for the flow total displayed on the <i>Home Screen</i> . <i>FLOW TOTAL UNITS</i> are automatically converted into the selected option:																
	<table border="1"> <thead> <tr> <th>Option</th> <th>Units</th> </tr> </thead> <tbody> <tr> <td>GAL</td> <td>US Gallons</td> </tr> <tr> <td>MGAL</td> <td>Million US Gallons</td> </tr> <tr> <td>IGAL</td> <td>Imperial Gallons</td> </tr> <tr> <td>AC-FT</td> <td>Acre Foot</td> </tr> <tr> <td>MIGAL</td> <td>Million Imperial Gallons</td> </tr> <tr> <td>Oil BBL</td> <td>Oil Barrels (42 Gal)</td> </tr> <tr> <td>Custom</td> <td>This selection is only available if <i>Custom Units</i> is enabled through SoloCUE Flow Device Manager. Use SoloCUE to change the <i>Custom Units</i>.</td> </tr> </tbody> </table>	Option	Units	GAL	US Gallons	MGAL	Million US Gallons	IGAL	Imperial Gallons	AC-FT	Acre Foot	MIGAL	Million Imperial Gallons	Oil BBL	Oil Barrels (42 Gal)	Custom	This selection is only available if <i>Custom Units</i> is enabled through SoloCUE Flow Device Manager. Use SoloCUE to change the <i>Custom Units</i> .
	Option	Units															
	GAL	US Gallons															
	MGAL	Million US Gallons															
	IGAL	Imperial Gallons															
	AC-FT	Acre Foot															
	MIGAL	Million Imperial Gallons															
Oil BBL	Oil Barrels (42 Gal)																
Custom	This selection is only available if <i>Custom Units</i> is enabled through SoloCUE Flow Device Manager. Use SoloCUE to change the <i>Custom Units</i> .																
<table border="1"> <thead> <tr> <th>Option</th> <th>Units</th> </tr> </thead> <tbody> <tr> <td>Fluid BBL</td> <td>Fluid Barrel (31.5 Gal)</td> </tr> <tr> <td>L</td> <td>Liter</td> </tr> <tr> <td>HL</td> <td>Hectoliter</td> </tr> <tr> <td>M³</td> <td>Cubic Meters</td> </tr> <tr> <td>FT³</td> <td>Cubic Feet</td> </tr> </tbody> </table>	Option	Units	Fluid BBL	Fluid Barrel (31.5 Gal)	L	Liter	HL	Hectoliter	M ³	Cubic Meters	FT ³	Cubic Feet					
Option	Units																
Fluid BBL	Fluid Barrel (31.5 Gal)																
L	Liter																
HL	Hectoliter																
M ³	Cubic Meters																
FT ³	Cubic Feet																
FLOW TOTAL DECIMALS	This is a numeric entry for the number of decimal places to display. Default is 0. Options are 0...7.																
VELOCITY UNITS	Select the units for the velocity displayed on the <i>Home Screen</i> . *FT/S Feet/Second M/S Meters/Second																
ENERGY RATE UNITS (Energy Units Only)	Select the units for the energy rate displayed on the <i>Home Screen</i> . <i>ENERGY RATE UNITS</i> are automatically converted into the selected option:																
	<table border="1"> <thead> <tr> <th>Option</th> <th>Units</th> </tr> </thead> <tbody> <tr> <td>BTU/H</td> <td>Btu/hour</td> </tr> <tr> <td>kBTU/H</td> <td>Thousand Btu/hour</td> </tr> <tr> <td>MMBTU/H</td> <td>Million Btu/hour</td> </tr> <tr> <td>W</td> <td>Watts</td> </tr> <tr> <td>*kW</td> <td>Kilowatts</td> </tr> <tr> <td>MW</td> <td>Megawatts</td> </tr> </tbody> </table>	Option	Units	BTU/H	Btu/hour	kBTU/H	Thousand Btu/hour	MMBTU/H	Million Btu/hour	W	Watts	*kW	Kilowatts	MW	Megawatts		
	Option	Units															
	BTU/H	Btu/hour															
	kBTU/H	Thousand Btu/hour															
	MMBTU/H	Million Btu/hour															
	W	Watts															
*kW	Kilowatts																
MW	Megawatts																
<table border="1"> <thead> <tr> <th>Option</th> <th>Units</th> </tr> </thead> <tbody> <tr> <td>kJ/H</td> <td>Kilojoules/hour</td> </tr> <tr> <td>MJ/H</td> <td>Mega joules/hour</td> </tr> <tr> <td>kCAL/H</td> <td>Kilocalories/hour</td> </tr> <tr> <td>MCAL/H</td> <td>Mega calories/hour</td> </tr> <tr> <td>TON (RT)</td> <td>Ton (Refrigeration) 1 Ton = 12,000 Btu/h</td> </tr> </tbody> </table>	Option	Units	kJ/H	Kilojoules/hour	MJ/H	Mega joules/hour	kCAL/H	Kilocalories/hour	MCAL/H	Mega calories/hour	TON (RT)	Ton (Refrigeration) 1 Ton = 12,000 Btu/h					
Option	Units																
kJ/H	Kilojoules/hour																
MJ/H	Mega joules/hour																
kCAL/H	Kilocalories/hour																
MCAL/H	Mega calories/hour																
TON (RT)	Ton (Refrigeration) 1 Ton = 12,000 Btu/h																
ENERGY RATE DECIMAL (Energy Units Only)	This is a numeric entry for the number of decimal places to display. Default is 2. Options are 0...7.																
ENERGY TOTAL MODE (Energy Units Only)	FORWARD FLOW REVERSE FLOW NET FLOW Forward flow minus reverse flow. A negative total results when reverse flow is greater than the forward flow. *GROSS FLOW Any flow in forward and reverse direction.																
ENERGY TOTAL UNITS (Energy Units Only)	Select the units for the energy total displayed on the <i>Home Screen</i> . <i>ENERGY TOTAL UNITS</i> are automatically converted into the selected option:																
	<table border="1"> <thead> <tr> <th>Option</th> <th>Units</th> </tr> </thead> <tbody> <tr> <td>BTU</td> <td>British Thermal Unit</td> </tr> <tr> <td>kBTU</td> <td>Thousand Btu</td> </tr> <tr> <td>MMBTU</td> <td>Million Btu</td> </tr> <tr> <td>KCAL</td> <td>Kilo Calories</td> </tr> <tr> <td>MCAL</td> <td>Mega Calories</td> </tr> </tbody> </table>	Option	Units	BTU	British Thermal Unit	kBTU	Thousand Btu	MMBTU	Million Btu	KCAL	Kilo Calories	MCAL	Mega Calories				
	Option	Units															
	BTU	British Thermal Unit															
	kBTU	Thousand Btu															
	MMBTU	Million Btu															
KCAL	Kilo Calories																
MCAL	Mega Calories																
<table border="1"> <thead> <tr> <th>Option</th> <th>Units</th> </tr> </thead> <tbody> <tr> <td>kWH</td> <td>Kilowatt Hour</td> </tr> <tr> <td>MWh</td> <td>Megawatt Hour</td> </tr> <tr> <td>kJ</td> <td>Kilo Joules</td> </tr> <tr> <td>MJ</td> <td>Mega Joules</td> </tr> <tr> <td>TON-H</td> <td>Ton-hour (Refrigeration)</td> </tr> </tbody> </table>	Option	Units	kWH	Kilowatt Hour	MWh	Megawatt Hour	kJ	Kilo Joules	MJ	Mega Joules	TON-H	Ton-hour (Refrigeration)					
Option	Units																
kWH	Kilowatt Hour																
MWh	Megawatt Hour																
kJ	Kilo Joules																
MJ	Mega Joules																
TON-H	Ton-hour (Refrigeration)																
ENERGY TOTAL DECIMALS (Energy Units Only)	This is a numeric entry for the number of decimal places to display. Default is 2. Options are 0...7.																
TEMPERATURE UNITS (Energy Units Only)	°F °C K																
DISPLAY MODE	Select the parameters to display on the <i>Home Screen</i> . Alternatively, you can change the display from the <i>Home Screen</i> by pressing the <i>DOWN</i> button. *FLOW RATE ENERGY TOTAL FLOW TOTAL TEMP #1 / TEMP #2 VELOCITY ENERGY RATE / DELTA TEMPERATURE RATE/TOTAL ENERGY RATE / ENERGY TOTAL ENERGY RATE TIME / DATE																

Setup > Meter

Contains all of the configuration parameters for setting the meter. Requires service level passcode or higher if security is enabled. An asterisk (*) indicates the parameter default.

Meter Submenus	Options/Descriptions	
TRANSDUCER	Select the transducer type:	
	UZ 2 MHZ	Option UZ when ordered with the TFX-5000 meter; universal small pipe transducers integrated in a rail
	CX 2 MHZ	Options CA...CT when ordered with the TFX-5000 meter; fixed size small pipe transducers
	JZ / KZ 1 MHZ	Options JZ and KZ when ordered with the TFX-5000 meter; medium size pipe transducers integrated in a rail
	NZ / RZ / WZ 1 MHZ	Options NZ, WZ and RZ when ordered with the TFX-5000 meter; medium size pipe transducers, including submersible
	HZ 1 MHZ	Option HZ when ordered with the TFX-5000 meter; high temperature medium pipe transducers
	LZ / YZ 0.5 MHZ	Option LZ and YZ when ordered with the TFX-5000 meter; large pipe transducers, including submersible
MOUNTING	For mounting options, see the transducer user manual. Z PATH *V PATH W PATH	
Cx TYPE	<i>Cx TYPE is substituted for MOUNTING when CX 2 MHZ is selected as the transducer type.</i> CA: 1/2 IN ANSI CJ: 1-1/4 IN COPPER CB: 3/4 IN ANSI CK: 1-1/2 IN COPPER CC: 1 IN ANSI CL: 2 IN COPPER CD: 1-1/4 IN ANSI CM: 1/2 IN SS TUBE CE: 1-1/2 IN ANSI CN: 3/4 IN SS TUBE CF: 2 IN ANSI CP: 1 IN SS TUBE CG: 1/2 IN COPPER CQ: 1-1/4 IN SS TUBE CH: 3/4 IN COPPER CR: 1-1/2 IN SS TUBE CT: 1 IN COPPER CS: 2 SS IN TUBE	

Setup > Meter > Pipe

An asterisk (*) indicates the parameter default.

Pipe Submenus	Options/Descriptions
PIPE MATERIAL	STAINLESS 302/303 STAINLESS 430 IRON - DUCTILE POLYPROPYLENE STAINLESS 304 ALUMINUM HD POLYETHYLENE STAINLESS 304L BRASS NAVAL LD POLYETHYLENE *STAINLESS 316 CARBON STEEL PFA TEFLON STAINLESS 347 COPPER PVC CPVC STAINLESS 410 IRON - CAST PVDF
PIPE TYPE	<p>For the best accuracy, measure the outer diameter and wall thickness with a gauge and select <i>MANUAL INCHES</i> or <i>MANUAL MM</i>.</p> <p>If you do not have a gauge, you can select an ASME/ANSI or ASTM definition. Schedule, copper tubing and cast iron class are filtered based on pipe material selection.</p> <p>If stainless steel pipe, carbon steel, cvc, pvc material is selected, the following pipe schedules are also available as applicable:</p> <p>SCHEDULE STD SCHEDULE 80 SCHEDULE 5 SCHEDULE 100 *SCHEDULE 10 SCHEDULE 120 SCHEDULE 20 SCHEDULE 140 SCHEDULE 30 SCHEDULE 160 SCHEDULE 40 SCHEDULE 180 SCHEDULE 60 SCHEDULE STG</p> <p>If copper material is selected, the following types are also available:</p> <p>TYPE K TYPE M TYPE L PIPE SIZE</p> <p>If cast iron pipe material is selected, the following classes are also available:</p> <p>CLASS A CLASS E CLASS B CLASS F CLASS C CLASS G CLASS D CLASS H</p> <p>If ductile iron pipe material is selected, the following classes are also available:</p> <p>CLASS 50 CLASS 54 CLASS 51 CLASS 55 CLASS 52 CLASS 56 CLASS 53</p> <p>If aluminum or brass naval material is selected, the following is also available:</p> <p>PIPE SIZE (in inches)</p>
PIPE SIZE	Available only when <i>PIPE TYPE</i> is <i>MANUAL</i> ; Numeric entry; min. 0.5 in (15 mm), max. 300 in (7500 mm)
PIPE SIZE NOMINAL	<i>PIPE SIZE NOMINAL</i> is substituted for <i>PIPE SIZE</i> when a schedule/tubing/class is selected. Enumeration based on schedule; min. 0.5 in. (15 mm), max. 24 in. (610 mm) 1/2, 3/4, 1, 1-1/4, 1-1/2, 2, 2-1/2, 3, 3-1/2, 4, 6, 8, 10, 12, 14, 16, 18, 20, 24
WALL THICKNESS	Numeric entry; *min. 0.00, max. 5 in. (125 mm); <i>WALL THICKNESS</i> is only useful for <i>MANUAL METRIC</i> and <i>MANUAL INCHES</i> ; It can be skipped for pipe schedule, tubing and classes
LINER MATERIAL	NONE HD POLYETHYLENE TAR EPOXY ACRYLIC LD POLYETHYLENE PFE TEFLON ASBESTOS CEMENT POLYPROPYLENE GLASS PYREX EBONITE POLYSTYRENE FIBERGLASS EPOXY MORTAR RUBBER
LINER THICKNESS	Numeric entry; min. 0.00, max. 5 in. (125 mm)
I.D. SIZE	Numeric display in inches or millimeters, based on <i>PIPE TYPE</i>

Setup > Meter > Fluid

Fluid Submenus	Options/Descriptions					
FLUID	Water - Tap	Acetone	Ethylene Glycol 30%	Kerosene	Propylene Glycol 30%	
	Raw Sewage	Ammonia	Gasoline	Methanol	Stoddard Solvent	
	Water - Distilled	Benzene	Glycerin	Oil Diesel #1	Sulfuric Acid 96%	
	Water - Sea 3.5%	Ethanol	Isopropanol	Oil Diesel #2	Hydrochloric Acid 36%	
	Brine - 3.5%	Ethylene Glycol 100%	Jet Fuel A1/JP8	Propylene Glycol 100%	Hydrofluoric Acid 49%	
	Brine - 10%	Ethylene Glycol 50%	Jet Fuel B/JP4	Propylene Glycol 50%	Custom	
CUSTOM FLUID	SOUND SPEED	Numeric entry; Units ft/s or m/s based on velocity units.				
	SPEED UNITS	Ft/s or m/s				
	SPECIFIC GRAVITY	Numeric entry; Specific gravity (density relative to water), pipe size and viscosity are used to calculate the Reynolds number. The Reynolds number indicates whether the fluid is in turbulent, transition or laminar flow and the flow profile.				
	VISCOSITY	Numeric entry; Units centipoise (cP) or mPa-s. Dynamic viscosity of the fluid.				
	VISCOSITY UNITS	Units centipoise (cP) or mPa-s				
	REFERENCE TEMP	Numeric entry, F or C. Default 15° C. Reference temperature of viscosity and specific gravity.				
	REF TEMP UNITS	F or C				
	SPECIFIC HEAT	Numeric entry; Units: joule/gram °C; min. 0.01, max. 65.0; Specific heat capacity is the heat capacity per unit mass of a material.				

Setup > Meter > Spacing

An asterisk (*) indicates the parameter default.

Spacing Submenus	Options/Descriptions
CALIBRATED SPACING	*Numeric display 0...300 units in inches or millimeters, based PIPE settings.
	The spacing required between two transducers based on the pipe parameters. Take this measurement between the lines scribed into the side of the transducers or use the scale on the rails, if used. See the transducer user manual. For Cx transducers with fixed spacing, the parameter will not be shown.

Setup > Meter > Flow Setup

An asterisk (*) indicates the parameter default.

Flow Setup Submenus	Options/Descriptions
DIRECTION	*FORWARD REVERSE
BIDIRECTIONAL	*ENABLED DISABLED
LOW FLOW CUTOFF	Numeric entry. Units and decimals are based on FLOW RATE UNITS. Zero and positive values. *0.0
SIGNAL CUTOFF	*30 The low threshold when the meter will stop reading flow and display a F10 Low Signal message (see "Troubleshooting" on page 46 for causes of a low signal).
SIGNAL HIGH	*90% The high threshold when the meter will stop reading flow and display a F11 High Signal message (see "Troubleshooting" on page 46 for causes of a high signal).
MINIMUM FLOW	-10000 (default); min. -2,000,000. Number of decimals points depends on Home Screen settings.
MAXIMUM FLOW	10000 (default); max. 2,000,000

Setup > Meter > Advanced

An asterisk (*) indicates the parameter default.

<i>HEAT CALCULATION</i> (Energy meter only)	Dynasonics Calculation EN1434 TYPE $Rate\ of\ Heat\ Delivery = Q \times (T_{in} - T_{out}) \times C \times \rho$ Where Q = Volumetric flow rate T _{in} = Temperature at the inlet T _{out} = Temperature at the outlet C = Heat capacity ρ = Density of fluid	
<i>DAMPING</i>	*40 seconds	For detailed information on these parameters, see the paragraphs following this table.
<i>SENSITIVITY</i>	*60%	
<i>HYSTERESIS</i>	*5%	
<i>BAD DATA REJECTION</i>	*3	
<i>FILTER METHOD</i>	*Adaptive	
<i>WAVE</i>	<ul style="list-style-type: none"> *AUTO automatically selects waveform based on flow speed and signal quality. SIN CARROT TOP is best for low speed flow. BEST BARKER is best for high speed flow. 	
<i>TEMP COMPENSATION</i>	*MANUAL TEMP #1 TEMP #2	Selection is only available for Energy meter. For the Flow meter, manual temperature compensation is always on. Temperature compensation adjusts the viscosity of the fluid used in Reynolds number compensation and the fluid speed of sound.
<i>MANUAL REF TEMP</i>	Numeric entry -40...350° F (-40...176° C)	
<i>REF TEMP UNITS</i>	° F ° C K	Select the units for the manual reference temperature.
<i>REYNOLDS</i>	*ENABLED DISABLED	Flow rate compensation based on fluid Reynolds number as the fluid changes from laminar to transitional to turbulent flow.

Filter Parameters

Filter Method (Default: Adaptive)

The TFX-5000 flow meter offers three levels of signal filtering:

- *None* imposes no filtering on the signal from the transducers.
- *Simple with Rejection* uses *Damping* and *Bad Data Rejection* to filter the flow data.
- **Adaptive* filtering allows the meter's software routines to alter the filtering, depending on the variability of the transducer's signal. The *Adaptive* filter uses a combination of *Damping*, *Bad Data Rejection*, *Sensitivity* and *Hysteresis* to modify the flow input data.

Damping (Range 0...100 Seconds; Default: 40 Seconds)

Damping is the approximate amount of time the filtering routines use to attain a 99% stable rate value. Generally, the higher the damping value, the more stable the rate readings are—but at the expense of response time.

Sensitivity (Range 0...100%; Default: 60%)

Sensitivity determines how fast the adaptive filtering responds to a change in rate. Increasing the sensitivity decreases the filtering, which allows the display to respond to rate changes more rapidly.

Hysteresis (Range 0...25%; Default: 5%)

Hysteresis creates a window around the average flow measurement reading, defining the limits at which the automatic damping increases occur. If the rate varies within the hysteresis window, greater damping occurs up to the maximum values set by the flow filter *Damping* entry. The filter also establishes a flow rate window where measurements outside of the window are captured by the *Bad Data Rejection* window. Enter the value as a percentage of actual flow rate.

For instance, a *Hysteresis* setting of 5% allows the flow to vary ± 5% from the currently established flow rate without automatically decreasing the value of the *Damping*.

For example, if the average flow rate is 100 gpm and the *Hysteresis* is set to 10%, a filter window of 90...110 gpm is established. Successive flow measurements that reside within that window are recorded and averaged in accordance with the *Damping* setting. Flow readings outside of the window are rejected or accepted in accordance with the *Bad Data Rejection* setting.

Filter settings for this example:

Filter Method	Adaptive
Damping	40 seconds
Sensitivity	60%
Hysteresis	10%
Bad Data Rejection	3

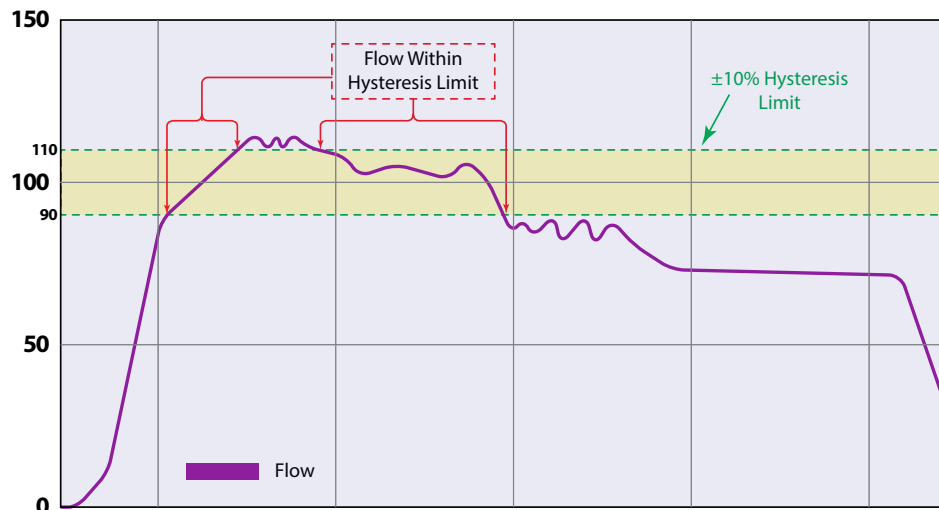

Figure 40: Hysteresis window

Bad Data Rejection (Range 0...10 Samples; Default: 3)

The *Bad Data Rejection* setting is related to the number of successive **readings** that must be measured outside of a the *Hysteresis* value before the flow meter considers the new flow value valid. In this example, a *Hysteresis* setting of 10% produces a $\pm 10\%$ band centered on the current valid flow rate of 100 gpm.

The *Bad Data Rejection* setting is the number of successive **samples** that must be outside of the *Hysteresis* window before the flow meter considers the change in flow as real. Larger values are entered into the *Bad Data Rejection* window when measuring liquids that contain gas bubbles, as the gas bubbles tend to disturb the ultrasonic signals and cause more extraneous flow readings to occur. Larger *Bad Data Rejection* values tend to make the flow meter less responsive to rapid changes in actual flow rate.

In [Figure 42 on page 30](#), flow data falls outside the flow *Hysteresis* window but does not reach the minimum time specified in the *Bad Data Rejection* window. When data appears that is outside the *Hysteresis* band and shorter than the *Bad Data Rejection* window time, the data is rejected.

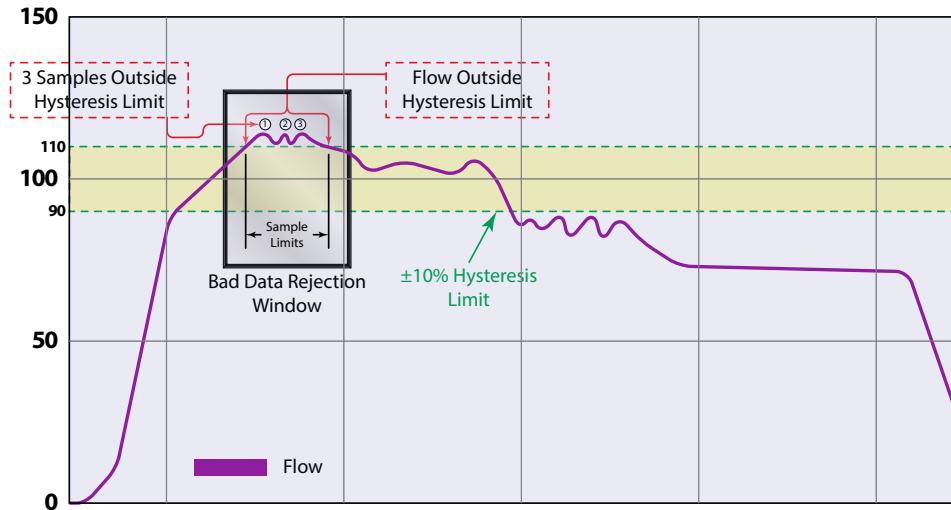

Figure 41: Bad data (rejection)

The flow rate is again outside the original $\pm 10\%$ Hysteresis window, but the data exists for a time period greater than the *Bad Data Rejection* window. In this instance, the meter interprets the data as a new valid flow rate and moves the *Hysteresis* window to correspond with the new established flow rate.

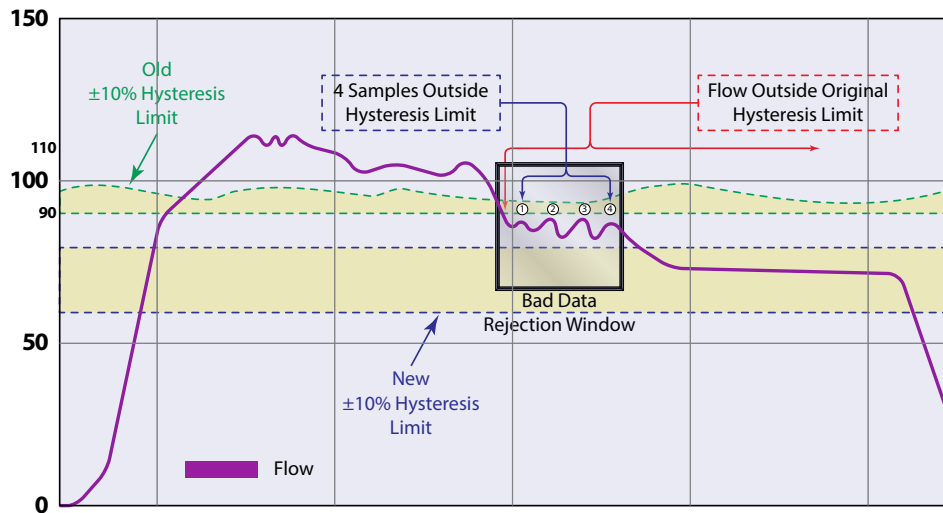

Figure 42: New valid flow data

Setup > Meter > Calibration

An asterisk (*) indicates the parameter default.

Calibration Submenus	Options/Descriptions	
<i>FACTOR MODE</i>	FACTORY *FIELD	Select <i>FIELD</i> to set the zero and use the sensor and scale factors of the transducers. Only selectable in firmware versions prior to 02.02.480.
<i>FACTORY SETTINGS</i>	ZERO	The zero offset entered during factory calibration. <i>ZERO</i> is for reference only and most likely the <i>ZERO VALUE</i> for your installation will be different from the factory <i>ZERO</i> . Numeric display; *0.000 ns
	CAL FACTOR	One of two calibration factors unique to each transducer pair if the transmitter was used during factory calibration. Numeric display #.###
	SENSOR FACTOR	One of two calibration factors unique to each transducer pair if the transmitter was used during factory calibration. Numeric display #.###
<i>ZERO MODE</i>	MANUAL *NO FLOW STEADY FLOW	Due to different pipe characteristics, the meter must be zeroed in order to maintain accuracy. The recommended method is to stop flow and make sure there is no flow before zeroing the meter. In situations in which that is not feasible, you may zero the meter while the flow is steady or enter the zero manually. Select the method to zero the meter.
<i>SET ZERO - NO FLOW</i>	SET ZERO AT NO FLOW in process and confirmation screen	Check that the pipe is full of liquid and not flowing. Flow must be absolutely zero. Securely close any valves and allow time for settling to occur.
<i>SET ZERO - FLOW</i>	SET ZERO AT FLOW in process and confirmation screen	Stabilize the flow to a steady level before zeroing the meter. In situations where it is not possible to stop flow, use this method to zero the meter. When selected, the meter will calculate the zero typically in 5...10 seconds and will indicate if the meter was successful or not in determining the flow.
<i>MANUAL ZERO</i>	Numeric entry ## ### ns	Allows for manual entry of the zero value when <i>ZERO MODE</i> is <i>MANUAL</i> .
<i>ZERO VALUE</i>	Numeric display ## ### ns	The zero offset used to calculate the flow rate. If the meter is not zeroed after installation, this value will match the factory <i>ZERO</i> setting.
<i>SENSOR FACTOR</i>	Numeric entry ## ### ns	The value used in calculating the zero value when zeroing the meter at steady flow. This value can be found on the transducer label.
<i>SCALE FACTOR</i>	Numeric entry	The factor used for linearizing the flow rate calculation when <i>FIELD</i> is selected for <i>FACTOR MODE</i> . Enter the <i>CAL FACTOR</i> from the transducer.

Factory Calibrated Procedure

Each transducer pair has a *CAL FACTOR* and *SENSOR FACTOR* on the label. Verify *FACTOR MODE* is set to *FIELD* and enter the factors from the transducer into the *CAL FACTOR* and *SENSOR FACTOR* settings.

Zero the meter after entering the *CAL FACTOR* and *SENSOR FACTOR*.

Field Calibration Procedure

To calibrate the TFX-5000 flow meter, use a master meter or gravimetric test stand.

- (Skip this step if firmware is 02.02.480 or higher.) Verify that *FACTOR MODE* is set to **FIELD** and the transducer sensor factor is entered into the *SENSOR FACTOR* setting.
- Set *SCALE FACTOR* set to **1**.
- Run calibration test.
- Calculate the *SCALE FACTOR*.
 $SCALE FACTOR = (\text{actual flow}) / (\text{meter flow rate})$ or $(\text{actual total}) / (\text{meter total})$
- Enter the *SCALE FACTOR*.

Setup > Input/Output > Current #1 (or Current #2)

Requires service level passcode or higher if security is enabled. The current output, reset input and frequency/pulse/status output can be set up through the *SETUP > INPUT/OUTPUT* menus.

An asterisk (*) indicates the parameter default.

Current #1 Submenus	Options/Descriptions	
<i>OUTPUT SOURCE</i>	*FLOW RATE TEMPERATURE #1 TEMPERATURE #2 ENERGY FLOW VELOCITY SIGNAL STRENGTH TEST MODE DISABLED	Select the reading to be assigned to the 4...20 mA output. Temperature and energy options only available with energy meter.
<i>RANGE</i>	*4-20 mA 4-20 mA NAMUR 0-20 mA	Current range is NAMUR 43 compliant with lower measuring limit at 3.8 mA and upper limit at 20.5 mA and minimum alarm 3.5 mA and maximum alarm 22.6 mA.
<i>MIN VALUE</i>	Enter the value of the reading at 4 mA. Can also be the setting for the 0 mA setpoint when 4-20 mA <i>RANGE</i> is selected. Units and decimal places based on parameter selected. Negative numbers accepted.	
<i>MAX VALUE</i>	Enter the value of the reading at 20 mA. Units and decimal places based on parameter selected. Negative numbers accepted.	
<i>FAILURE MODE</i>	*MIN CURRENT MAX CURRENT LAST VALUE TEST CURRENT	When an Fxx error occurs, such as low signal strength, the transmitter will set the current output the selected value.
<i>FIXED VALUE</i>	Enter the value for the current output when there is a failure mode. This parameter is only displayed with <i>FAILURE MODE</i> is set to <i>FIXED VALUE</i> .	
<i>TEST CURRENT</i>	Available only when <i>OUTPUT SOURCE</i> is in <i>TEST MODE</i> . Default 12.00 mA. To check the wiring to the control system or gauge, you can override the current output with a fixed current. Numeric entry mA. 0...22 mA.	
<i>TRIM 4 mA</i>	Available only when <i>OUTPUT SOURCE</i> is in <i>TEST MODE</i> . Set the test current to 4 mA or 0 mA, depending on the current range selected. Adjusts output until PLC/DCS/BAS reads the desired value.	
<i>TRIM 20 mA</i>	Available only when <i>OUTPUT SOURCE</i> is in <i>TEST MODE</i> . Set the test current to 20 mA. Adjusts output until PLC/DCS/BAS reads 20 mA.	

Setup > Inputs/Output > Output #1 (or Output #2 or Output #3)

Output #1, Output #2 or Output #3 can operate independently as a frequency, totalizer pulse, direction status or alarm status output. In the *SETUP > INPUT/OUTPUTS > OUTPUT #1 (OR OUTPUT #2 OR OUTPUT #3) > MODE* menu, select the *MODE* of operation. Then go to the *PARAMETERS* menu to set up the operation for that *MODE*.

Output #3 is available on the energy unit only.

An asterisk (*) indicates the parameter default.

Output #1 Submenus	Options/Descriptions												
<i>MODE</i>	*FREQUENCY PULSE TOTAL FLOW DIRECTION ALARM DISABLED	FREQUENCY and PULSE TOTAL modes are not available with AUX OUTPUT #1 and #2 dry contact output.											
<i>PARAMETERS</i> (Frequency Mode)	OUTPUT SOURCE	*FLOW RATE VELOCITY ENERGY FLOW (Energy meter only) TEST FREQUENCY	Select the reading to assign to the frequency output.										
	VALUE AT 0 HZ	Numeric entry. Units and decimal place based on parameter selected. Negative numbers accepted. Default -5000.	Enter the maximum flow rate or velocity frequency that corresponds to maximum frequency flow rate or velocity. Can be negative to indicate reverse flow. The units of <i>Maximum</i> match the units in <i>SETUP > MEASUREMENTS > FLOW UNITS</i> .										
	MAX VALUE	Numeric entry. Units and decimal place based on source selected. Negative numbers accepted. Default 5000.	Example 1: For a system that only has flow in one direction, the maximum flow rate is 100 gal/min, and the corresponding maximum frequency is 2000 Hz, set up the parameters to:										
			<table border="1"> <thead> <tr> <th>Parameter</th> <th>Value</th> </tr> </thead> <tbody> <tr> <td>Output Source</td> <td>Flow Rate</td> </tr> <tr> <td>Minimum</td> <td>0 gal/min</td> </tr> <tr> <td>Maximum</td> <td>100 gal/min</td> </tr> <tr> <td>Maximum Frequency</td> <td>2000 Hz</td> </tr> </tbody> </table>	Parameter	Value	Output Source	Flow Rate	Minimum	0 gal/min	Maximum	100 gal/min	Maximum Frequency	2000 Hz
	Parameter	Value											
Output Source	Flow Rate												
Minimum	0 gal/min												
Maximum	100 gal/min												
Maximum Frequency	2000 Hz												
MAX FREQUENCY	Numeric entry. Units in Hz. Default 1 kHz.	Example 2: For a system that flow is bidirectional, the flow rate ranges from -100 gal/min to 100 gal/min and the frequency at 100 gal/min is 2000 Hz, set up the parameters to:											
		<table border="1"> <thead> <tr> <th>Parameter</th> <th>Value</th> </tr> </thead> <tbody> <tr> <td>Output Source</td> <td>Flow Rate</td> </tr> <tr> <td>Minimum</td> <td>-100 gal/min</td> </tr> <tr> <td>Maximum</td> <td>100 gal/min</td> </tr> <tr> <td>Maximum Frequency</td> <td>2000 Hz</td> </tr> </tbody> </table> <p>With this setup at <i>no flow</i>, the frequency output is 1000 Hz.</p>	Parameter	Value	Output Source	Flow Rate	Minimum	-100 gal/min	Maximum	100 gal/min	Maximum Frequency	2000 Hz	
Parameter	Value												
Output Source	Flow Rate												
Minimum	-100 gal/min												
Maximum	100 gal/min												
Maximum Frequency	2000 Hz												
TEST FREQUENCY	Available when <i>TEST MODE</i> is selected for <i>OUTPUT SOURCE</i> . To check the wiring to the control system or device, you can override the frequency output with a fixed frequency.												

Output #1 Submenus	Options/Descriptions			
PARAMETERS (Pulse Total Mode)	OUTPUT SOURCE	*POSITIVE FLOW NEGATIVE FLOW BIDIRECTIONAL FLOW Also available for energy meters: POSITIVE ENERGY NEGATIVE ENERGY BIDIRECTIONAL ENERGY	Select whether the pulse output accumulates only on positive (forward) flow, only on negative (reverse) flow or anytime flow occurs regardless of the flow direction (bidirectional). For bidirectional, assign the direction status to the other output, if desired.	
	SCALING FACTOR	Numeric entry. Units and decimal place based on flow rate selection. Default is 1 unit per pulse. Enter the number of totalizer units per pulse. The totalizer unit is in the <i>SETUP > MEASUREMENTS</i> menu. For example, if the totalizer unit is gallons, setting the <i>PULSES/UNIT</i> to 10 transmits 1 pulse every 10 gallons. Setting the <i>SCALING FACTOR</i> to 0.1 transmits 1 pulse every 0.1 gallons.		
	PULSE WIDTH	Numeric entry 1...2000 ms. Default 50 ms. Enter the pulse width in milliseconds.		
	PULSE STATE	*PULSE LOW PULSE HIGH	<i>PULSE LOW</i> , the pulse totalizer output remains in the off state and the voltage floats at the source voltage level. When the pulse is triggered, the output turns on and the voltage drops to the low voltage level. This setup uses the least power. If the pulse needs to be at the high voltage level, use the <i>PULSE HIGH</i> option.	
PARAMETERS (Flow Direction Mode)	OUTPUT SOURCE	*FLOW RATE ENERGY FLOW		
	DIRECTION	FORWARD ON *REVERSE ON For energy meters only: ENERGY FORWARD ENERGY REVERSE	Select whether the output is active when the flow is forward or reverse. When the absolute value of the flow rate is below the cutoff, the output will not be active.	
	OUTPUT STATE	OUTPUT LOW	The output remains in the off state and the voltage floats at the source voltage level. When the output turns on, the voltage drops to the low voltage level.	
		OUTPUT HIGH	Use if the output needs to be at the high voltage when the direction is detected.	

Output #1 Submenus	Options/Descriptions		
PARAMETERS (Alarm Mode)	ALARM	*ERRORS ONLY HIGH FLOW LOW FLOW HI/LO FLOW For energy meters only: HIGH ENERGY LOW ENERGY HI/LO ENERGY HIGH TEMP1 HIGH TEMP2 LOW TEMP1 LOW TEMP2	Select the flow condition or meter condition to trigger the alarm and turn on the output.
	SET HIGH	Numeric entry. Units and decimal place based on FLOW RATE selected. Negative numbers accepted. Default is 10000.	Enter the value that the flow rate must be greater than in order to trigger an alarm. <i>SET HIGH</i> is only visible/settable when <i>ALARM</i> is set to <i>HIGH FLOW</i> , <i>OUT OF RANGE</i> or <i>ALL</i> .
	SET LOW	Numeric entry. Units and decimal place based on FLOW RATE selected. Negative numbers accepted. Default is 0.	Enter the value that the flow rate must be less than in order to trigger an alarm. <i>SET LOW</i> is only visible/settable when <i>ALARM</i> is set to <i>LOW FLOW</i> , <i>OUT OF RANGE</i> or <i>ALL</i> .
	LATCHING	*DISABLED ENABLED	When <i>ENABLED</i> , the output remains on after the alarm condition clears. Resetting alarm latch turns off the output.
	ANTI-CHATTER	SET DELAY	Enter how long the alarm condition must occur before activating the output to prevent nuisance trips. Numeric entry. Units: Milliseconds. Default is 100 ms.
		HYSTERESIS	Enter how long the alarm condition is cleared before resetting the output to prevent the output from chattering. The parameter is only valid if <i>LATCHING</i> is <i>DISABLED</i> . Numeric entry. Default is 100 ms.
		MIN ON-TIME	Numeric entry. Units: Milliseconds. Default is 200 ms.
	OUTPUT STATE	OUTPUT LOW	The output remains in the off state and the voltage floats at the source voltage level. When the output turns on, the voltage drops to the low voltage level.
OUTPUT HIGH		Use if the output needs to be at the high voltage when the direction is detected.	
PULL UP RESISTOR	INTERNAL *EXTERNAL	See "Digital Outputs Wiring" on page 18.	

Power Indication

The transmitter has a 24V DC power output (ISO 24V OUT) for the 4...20 mA outputs and can be used for power indication of the transmitter. For externally powered indication, use either an open collector or an optional auxiliary dry contact. Program an alarm condition that will always be on when the meter is powered, such as a low flow alarm threshold set above the maximum flow rate. For an open collector output, set the *Output State* to *Output Low* to energize the output.

Setup > Inputs/Output > Aux Output #1 (or Aux Output #2)

This menu shows only with card installed for *AUTODETECT* or *CARD TYPE* is set to *AUX OUTPUT*.

An asterisk (*) indicates the parameter default.

Output #1 Submenus	Options/Descriptions			
<i>MODE</i>	FLOW DIRECTION FREQUENCY and PULSE TOTAL modes are not available with AUX OUTPUT card. ALARM DISABLED			
<i>PARAMETERS</i> (Flow Direction Mode)	OUTPUT SOURCE	*FLOW RATE ENERGY FLOW		
	DIRECTION	FORWARD ON *REVERSE ON For energy meters only: ENERGY FORWARD ENERGY REVERSE	Select whether the output is active when the flow is forward or reverse. When the absolute value of the flow rate is below the cutoff, the output will not be active.	
	OUTPUT STATE	OUTPUT HIGH OUTPUT LOW	Select <i>OUTPUT HIGH</i> to close the contact when the condition is met. Select <i>OUTPUT LOW</i> to close the contact when the transmitter is powered and open the contact when the condition is met.	
<i>PARAMETERS</i> (Alarm Mode)	ALARM	*ERRORS ONLY HIGH FLOW LOW FLOW HI/LO FLOW For energy meters only: HIGH ENERGY LOW ENERGY HI/LO ENERGY HIGH TEMP1 HIGH TEMP2 LOW TEMP1 LOW TEMP2	Select the flow condition or meter condition to trigger the alarm and turn on the output.	
	SET HIGH	Numeric entry. Units and decimal place based on FLOW RATE selected. Negative numbers accepted. Default is 10000.	Enter the value that the flow rate must be greater than in order to trigger an alarm. <i>SET HIGH</i> is only visible/settable when <i>ALARM</i> is set to <i>HIGH FLOW</i> , <i>OUT OF RANGE</i> or <i>ALL</i> .	
	SET LOW	Numeric entry. Units and decimal place based on FLOW RATE selected. Negative numbers accepted. Default is 0.	Enter the value that the flow rate must be less than in order to trigger an alarm. <i>SET LOW</i> is only visible/settable when <i>ALARM</i> is set to <i>LOW FLOW</i> , <i>OUT OF RANGE</i> or <i>ALL</i> .	
	LATCHING	*DISABLED ENABLED	When <i>ENABLED</i> , the output remains on after the alarm condition clears. Resetting alarm latch turns off the output.	
	ANTI-CHATTER	SET DELAY	Enter how long the alarm condition must occur before activating the output to prevent nuisance trips. Numeric entry. Units: Milliseconds. Default is 100 ms.	
		HYSTERESIS	Enter how long the alarm condition is cleared before resetting the output to prevent the output from chattering. The parameter is only valid if <i>LATCHING</i> is <i>DISABLED</i> . Numeric entry. Default is 100 ms.	
		MIN ON-TIME	Numeric entry. Units: Milliseconds. Default is 200 ms.	
OUTPUT STATE	OUTPUT HIGH OUTPUT LOW	Select <i>OUTPUT HIGH</i> to close the contact when the condition is met. Select <i>OUTPUT LOW</i> to close the contact when the transmitter is powered and open the contact when the condition is met.		

Power Indication

To use an auxiliary output for power indication, program an alarm condition that will always be on when the meter is powered, such as a low flow alarm threshold set above the maximum flow rate. Set the *OUTPUT STATE* to *OUTPUT HIGH* to close the contact when the transmitter is powered up.

Setup > Inputs/Output > Input

An asterisk (*) indicates the parameter default.

Input Submenus	Options/Descriptions
MODE	DISABLED
	*RESET TOTAL
	UNLATCH ALARM
STATE	*ACTIVE ON HIGH
	ACTIVE ON LOW

Select the action to take when the input is active (based on the state).

Select the voltage level to make the input active.

Setup > Inputs/Output > RTD (Energy Models Only)

An asterisk (*) indicates the parameter default.

RTD Submenus	Options/Descriptions
TEMP SENSOR TYPE	Pt1000 2-WIRE
	Pt1000 3-WIRE
	Pt1000 4-WIRE
	Pt100 2-WIRE
	Pt100 3-WIRE
	Pt100 4-WIRE
RANGE	32...122° F (0...50° C)
	32...212° F (0...100° C)
	-40...392° F (-40...200° C)
	4...86° F (-20...30° C)
DELTA TEMP	TEMP #1-TEMP #2 TEMP #2-TEMP #1
TRIM RTD #1	Adjust the offset for the temperature reading for RTD #1.
TRIM RTD #2	Adjust the offset for the temperature reading for RTD #2.

Select the temperature sensor type.

Select the temperature range.

Select the order for positive and negative energy calculations.

See ["Troubleshooting" on page 46](#) before adjusting the RTD input.

Trimming the RTDs

1. Change the *Home Screen* on the transmitter to read the temperature of the RTDs.
2. Connect a computer with SoloCUE Flow Device Manager software to the TFX-5000 transmitter. In the *Setup > Input* tab, check the *Temp Sensor Type* and *Range*.
3. With a constant temperature controlled heat source at the midpoint of the operating range, heat RTD 1. Allow time for the RTD to heat thoroughly.
4. Compare the temperature of the heat source with the temperature reading of *Temp 1* on the display. In SoloCUE, adjust the *Trim RTD 1* until *Temp 1* matches the heat source temperature.
5. Repeat steps #3 and #4 for RTD 2.

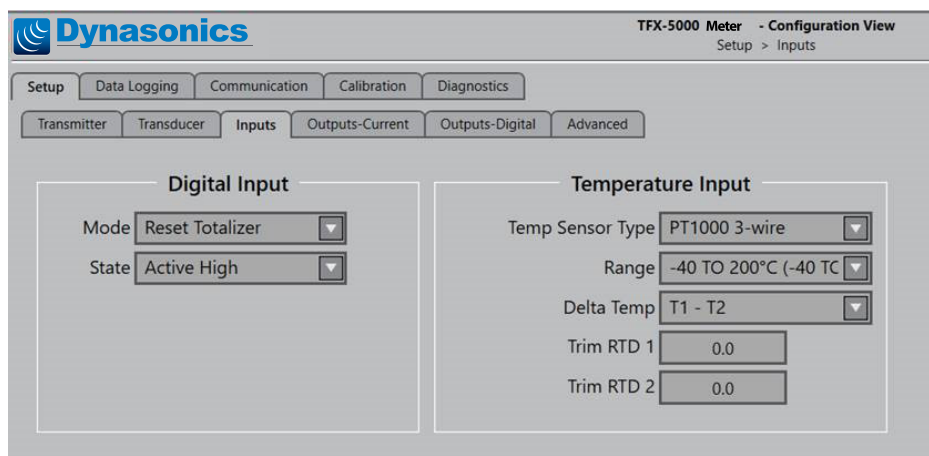

Figure 43: Trimming the RTDs

Setup > Communications

Requires service level passcode or higher if security is enabled. For addressing information, see the "[TFX-5000 Meter Modbus RTU Protocol](#)" user manual or the "[TFX-5000 Meter BACnet MS/TP Protocol](#)" user manual, available at www.badgermeter.com.

An asterisk (*) indicates the parameter default.

Communication Submenus	Options/Descriptions	
EIA-485 TYPE	DISABLE	Either disable this feature or select a network type.
	*MODBUS RTU	
	BACNET MS/TP	
MODBUS RTU SETTINGS (Displayed when MODBUS RTU is selected as the option for EIA-485 TYPE.)	ADDRESS	Numeric entry 1...254
	BAUD RATE	*AUTO, 9600, 19200, 38400, 57600, 76800, 115200
	ACCESS	WRITE/READ allows full access. RESET/READ allows you to read any, but only write to <i>Flow Total Reset</i> (cannot set up meter). READ ONLY allows read only.
	PARITY	*NONE ODD PARITY EVEN PARITY
	STOP BIT	*1 STOP BIT 2 STOP BITS
	RESISTOR	*DISABLED ENABLED
	WORD ORDER	BIG ENDIAN *LITTLE ENDIAN For 32-bit numbers or data types spanning over multiple registers, select the order of the 16-bit word or register to match the Modbus RTU master.
TIMEOUT	Numeric entry 0... 10000 ms Enter 0 ms to disable the timeout option. For networks with a predictable poll rate by the master device, this parameter is an option to record and display an S60 code when the meter does not receive a message from the master device. Enter the time that the TFX-5000 meter should record and display a loss of communication timeout.	
BACNET MS/TP SETTINGS	MAC ADDRESS	Numeric entry 0...127
	BACNET ID	Numeric entry 0...4194303
	BAUD RATE	*9600, 19200, 38400, 57600, 76800, 115200
	ACCESS	WRITE/READ allows full access. RESET/READ allows you to read any, but only write to <i>Flow Total Reset</i> (cannot set up meter). READ ONLY allows read only.
	MAX MASTER	Numeric entry 1...127
	PARITY	*NONE ODD PARITY EVEN PARITY
	STOP BIT	*1 STOP BIT 2 STOP BITS
RESISTOR	DISABLED *ENABLED	
ENDPOINT	Select the settings to match the BEACON/AquaCUE settings. Only the flow total selected for the <i>Home Screen</i> will be sent. Energy totals are not supported.	
	DIAL COUNT	7, *8, 9, 10
	RESOLUTION	*OFF, 1, 10, 100, 1000, 10000, 0.1, 0.01, 0.001, 0.0001
	PROTOCOL	*DISABLED V1 V2 V3 When an ORION endpoint is connected to the transmitter, select the settings to match the BEACON/AquaCUE settings. Only the flow total selected for the <i>Home Screen</i> will be sent. V1 protocol does not support dial counts above 7.

Communication Submenus	Options/Descriptions	
<i>BACNET/IP</i> (Shows only with card installed for AUTODETECT or CARD TYPE is set to BACNET/IP.)	WEBSERVER	Note: WEBSERVER is READ ONLY. *ENABLED DISABLED
	CLIENT TIMEOUT	0...65,535 ms
	DEVICE INSTANCE	BACnet ID range: 0...99,999,999
	DHCP	*DISABLED ENABLED
	IP ADDRESS	Numeric entry ###.###.###.###. Enter a value from 1...255 for the first value and 0...255 for the remaining values. Option not available if DHCP is enabled.
	SUBNET MASK	Numeric entry ###.###.###.###. Enter each value from 0...255. Option not available if DHCP is enabled.
	GATEWAY	Numeric entry ###.###.###.###. Enter a value from 1...255 for the first value and 0...255 for the remaining values. Option not available if DHCP is enabled.
	DNS PRIMARY	###.###.###.### Enter a value from 1...255 for the first value and 0-255 for the remaining values. It is not recommended to use static IP address in the range of 169.254.0.0 to 169.254.255.255 because clients may not be able to locate the DNS server.
	DNS SECONDARY	###.###.###.### Enter a value from 1...255 for the first value and 0...255 for the remaining values. It is not recommended to use static IP address in the range of 169.254.0.0 to 169.254.255.255 because clients may not be able to locate the DNS server.
	PORT	Use SoloCUE if you need to change the UDP port from the default setting: *AUTO NEGOTIATION 10 Mbit HALF DUPLEX 10 Mbit FULL DUPLEX 100 Mbit HALF DUPLEX 100 Mbit FULL DUPLEX
	ACCESS	WRITE/READ allows full access RESET/READ allows you to read any, but only write to <i>Flow Total Reset</i> (cannot set up meter) *READ ONLY allows read only
<i>MODBUS TCP/IP</i>	WEBSERVER	Note: WEBSERVER is READ ONLY. *ENABLED DISABLED
	CLIENT TIMEOUT	0...65,535 ms
	WORD ORDER	BIG ENDIAN *LITTLE ENDIAN
	DHCP	*DISABLED ENABLED
	IP ADDRESS	Numeric entry ###.###.###.###. Enter a value from 1...255 for the first value and 0...255 for the remaining values. Option not available if DHCP is enabled.
	SUBNET MASK	Numeric entry ###.###.###.###. Enter each value from 0...255. Option not available if DHCP is enabled.
	GATEWAY	Numeric entry ###.###.###.###. Enter a value from 1...255 for the first value and 0...255 for the remaining values. Option not available if DHCP is enabled.
	DNS PRIMARY	###.###.###.### Enter a value from 1...255 for the first value and 0...255 for the remaining values. It is not recommended to use static IP address in the range of 169.254.0.0 to 169.254.255.255 because clients may not be able to locate the DNS server.
	DNS SECONDARY	###.###.###.### Enter a value from 1...255 for the first value and 0...255 for the remaining values. It is not recommended to use static IP address in the range of 169.254.0.0 to 169.254.255.255 because clients may not be able to locate the DNS server.
	PORT	*AUTO NEGOTIATION 10 Mbit HALF DUPLEX 10 Mbit FULL DUPLEX 100 Mbit HALF DUPLEX 100 Mbit FULL DUPLEX
	ACCESS	WRITE/READ allows full access RESET/READ allows you to read any, but only write to <i>Flow Total Reset</i> (cannot set up meter) *READ ONLY allows read only

Communication Submenus	Options/Descriptions	
ETHERNET/IP (Shows only with card installed for AUTODETECT or CARD TYPE is set to ETHERNET/IP.)	WEBSERVER	Note: WEBSERVER is READ ONLY. *DISABLED ENABLED
	DHCP	*DISABLED ENABLED
	IP ADDRESS	Numeric entry ###.###.###.###. Enter a value from 1...255 for the first value and 0...255 for the remaining values. Option not available if DHCP is enabled.
	SUBNET MASK	Numeric entry ###.###.###.###. Enter each value from 0...255. Option not available if DHCP is enabled.
	GATEWAY	Numeric entry ###.###.###.###. Enter a value from 1...255 for the first value and 0...255 for the remaining values. Option not available if DHCP is enabled.
	DNS PRIMARY	###.###.###.### Enter a value from 1...255 for the first value and 0...255 for the remaining values. It is not recommended to use static IP address in the range of 169.254.0.0 to 169.254.255.255 because clients may not be able to locate the DNS server.
	DNS SECONDARY	###.###.###.### Enter a value from 1...255 for the first value and 0...255 for the remaining values. It is not recommended to use static IP address in the range of 169.254.0.0 to 169.254.255.255 because clients may not be able to locate the DNS server.
	PORT	Use SoloCUE if you need to change the TCP or UDP port from the default setting: *AUTO NEGOTIATION 10 Mbit HALF DUPLEX 10 Mbit FULL DUPLEX 100 Mbit HALF DUPLEX 100 Mbit FULL DUPLEX
	ACCESS	WRITE/READ allows full access RESET/READ allows you to read any, but only write to <i>Flow Total Reset</i> (cannot set up meter) *READ ONLY allows read only

Setup > Data Logging (Service Level Access)

Requires service level passcode or higher if security is enabled.

Due to FAT32 limitation on the microSD card, if the file size exceeds 4 GB, the log file will be closed and a new file started. Both files will be accessible. The name of the files are FILE0001.txt, FILE0002.txt, and so on. Log files are automatically saved as .txt files to the microSD card. Before removing the microSD card, change the LOG MODE to DISABLED. With an 8 GB microSD card installed, the card will have enough memory to last about 1-1/2 years when logging 8 parameters at a 1 second time interval.

Data Logging Submenus	Options/Descriptions		
LOG MODE	New log file created when parameters are added or removed from data log. *DISABLED CONTINUOUS Logs when transmitter is on and operating. THRESHOLD Logs when the threshold value is between the minimum and maximum values. For example, only log when process equipment is operational and flow is above cutoff.		
TIME INTERVAL	1 SECOND 2 SECONDS 5 SECONDS 10 SECONDS 20 SECONDS 30 SECONDS	1 MINUTE 2 MINUTES 5 MINUTES 10 MINUTES 30 MINUTES	1 HOUR 2 HOURS 4 HOURS 6 HOURS 12 HOURS 24 HOURS
PARAMETER #1 PARAMETER #8	NOTE: For error/alarm codes, the last 10 codes in the history are logged with commas separating the values. FLOW RATE DELTA TRANSIT TIME ENERGY TOTAL FORWARD FLOW TOTAL GROSS TEMPERATURE #1 ENERGY TOTAL REVERSE FLOW TOTAL FORWARD TEMPERATURE #2 ENERGY TOTAL NET FLOW TOTAL REVERSE TEMP#1 - TEMP#2 SIGNAL STRENGTH FLOW TOTAL NET TEMP#2 - TEMP#1 SOUND SPEED VELOCITY ENERGY RATE ERROR/ALARM CODE REYNOLDS ENERGY TOTAL GROSS NONE		
THRESHOLD	If THRESHOLD control is selected, this setting will be active. FLOW RATE FLOW TOTAL TEMPERATURE #1 TEMPERATURE #2 DELTA TEMPERATURE ENERGY RATE ENERGY TOTAL VELOCITY		
MIN THRESHOLD	Numeric entry (plus or minus)	If THRESHOLD log model is selected, this setting will be active.	
MAX THRESHOLD	Numeric entry (plus or minus)	If THRESHOLD log model is selected, this setting will be active.	
DELETE LOG	Will stop recording and delete all records. Prompt with a confirmation screen.		

Setup > Options

Options Submenu	Options/Descriptions
CARD TYPE	If CARD TYPE is set to AUTODETECT, the transmitter will automatically detect when a new card is installed and display menu for the card settings. If CARD TYPE is set to a specific communication/contact card, the card settings will remain for that card type even if it is not installed. If a different card is installed or no card is installed, a warning will be displayed on the Home Screen and the card will be inactive. If CARD TYPE is set to DISABLED, then the card connection will be disabled and the Ethernet and contact menus will not be displayed. DISABLED AUTODETECT BACNET/IP MODBUS TCP/IP ETHERNET/IP AUX OUTPUT

Setup > Passcode Setup > Security

If *SECURITY* is enabled and you exit the *MAIN MENU*, you must re-enter your passcode to access the *MAIN MENU* again.

The passcodes are the same for the display/keypad access and SoloCUE Flow Device Manager access. Each time the menus are accessed either through the display/keypad interface or through SoloCUE, a valid passcode must be entered to change parameters. The logged in security level of the display/keypad and SoloCUE are independent. For example, a person can log in at the Service level through the display/keypad, while another person logs in at the Admin level through SoloCUE.

Passcode Setup offers three levels of access. Read-Only access does not require a passcode:

- ADMIN—You must enter the fault *ADMIN* passcode 000000 to change Security between *DISABLE* and *ENABLE* or to set any passcode or the *Logout Timeout*.
- OPERATOR
- SERVICE

Security Submenus	Options/Descriptions	
<i>SET ADMIN</i>	6-digit passcode	Numeric entry
<i>SET OPERATOR</i>	6-digit passcode	Numeric entry
<i>SET SERVICE</i>	6-digit passcode	Numeric entry
<i>LOGOUT TIMEOUT</i>	1 MINUTE 5 MINUTES *10 MINUTES 20 MINUTES 30 MINUTES 60 MINUTES	When logout occurs, the display returns to the <i>Home Screen</i> .

Setup > Passcode Setup > Passcode Recovery

An asterisk (*) indicates the parameter default.

Passcode Setup Submenus	Options/Descriptions	
<i>PASSCODE RECOVERY</i>	Passcode recovery screen	
<i>TEMPORARY PASSCODE</i>	Numeric entry	After 20 attempts to enter the temporary passcode, you will be prompted to generate a new <i>RECOVERY CODE</i> .
<i>SECURITY</i>	*DISABLED ENABLED	When <i>SECURITY</i> is enabled, you are prompted to set the service and operator passwords. If you do not, the defaults remain in place.

Only the *ADMIN* level can reset passcodes. If the *ADMIN* passcode is lost and the passcodes need to be reset, you can contact Badger Meter, provide a recovery code to the representative and request a temporary passcode.

To generate a recovery code:

1. Select **PASSCODE RECOVERY**.
2. The next screen prompts you to generate a recovery code or cancel the request. When you request the code, it displays on the screen. Write the number in a safe place. No one will be able to view the recovery code if you exit the screen or reboot the meter.
3. Press **MENU/BACK** and continue to operate the meter in read-only mode.

You will not be prompted to enter a passcode when you navigate the menus. You have the option of canceling the recovery process and continue to use the existing passcodes by entering the *ADMIN* passcode. The *PASSCODE LEVEL* in the *DIAGNOSTIC* menu will be set to *RECOVERY* until you successfully enter a new *ADMIN* passcode or cancel the recovery.

When you receive your temporary passcode, select **SETUP > PASSCODE SETUP > TEMPORARY PASSCODE** and enter your temporary passcode. You will automatically be prompted to enter a new *ADMIN* passcode (prompt will be either in the SoloCUE software utility or the front panel, depending on where the temporary passcode was entered). If you do not enter a new *ADMIN* passcode within 15 minutes, the recovery mode is canceled and you must request a new recovery code to reset the passcodes. *TEMPORARY PASSCODE* can be entered from the SoloCUE software utility or the front panel, regardless of what was used to start it.

Display Menu

Requires operator level passcode or higher if security is enabled. An asterisk (*) indicates the parameter default.

Display Submenus	Options/Descriptions	
LANGUAGE	*ENGLISH	English
	DEUTSCHE	German
	ESPAÑOL	Spanish
	FRANÇAIS	French
	ITALIANO	Italian
DECIMAL	## #,#	Select whether the decimal indicator is a period or a comma.
DISPLAY TAG ID	*DISABLED ENABLED	Displays the TAG ID on the Home Screen. Default is TFX-5000. Use SoloCUE to change the TAG ID.
BRIGHTNESS	Select the display brightness 10...100% in increments of 10. Default is 70%.	
CONTRAST	Adjust the screen contrast 12...37. Default is 24.	
DIMMER	*ENABLED DISABLED	Enable the DIMMER to reduce the display BRIGHTNESS after the buttons are not pressed for the TIMEOUT period. Select the BRIGHTNESS level. Default is 10%. Press any button to awaken the transmitter and return to normal BRIGHTNESS. The buttons pressed will not be active for one second after the transmitter is awakened.
DIMMER LEVEL	OFF	
	10%	
	20%	
	30%	
	40%	
	50%	
	60%	
70%		
80%		
90%		
100%		
TIMEOUT	5 MINUTES	
	*10 MINUTES	
	20 MINUTES	
	30 MINUTES	
	60 MINUTES	
SET TIME	Numeric entry for 24 hour clock HH:MM	
SET DATE	Numeric entry for date YYYY-MM-DD	
DISPLAY TIME	24 HOUR AM / PM	Select format of the time to display on the Home Screen and on the SoloCUE dashboard.
DISPLAY DATE	YYYY-MM-DD MM-DD-YYYY DD-MM-YYYY	Select format of the date to display on the Home Screen and on the SoloCUE dashboard.

Information Menu

An asterisk (*) indicates the parameter default.

Information Submenus	Options/Descriptions
VENDOR	BADGER METER
MODEL	TFX-5000
P.N.:	Badger Meter part number
S.N.	Serial Number
FW VERSION	Firmware Version xx.xx.xxx
CAL. DATE	Calibration Date YYYY-MM-DD
DATE CODE	Manufacture Date YYYY-MM-DD
TAG ID	16 characters

Diagnosics Menu

The *DIAGNOSTICS* menu displays system status and allows you to clear the history, reset to factory defaults and reboot the system. An asterisk (*) indicates the parameter default.

Diagnosics Submenus	Options/Descriptions			
READINGS	SIGNAL STRENGTH	Read-only numeric with message to indicate the quality of the ultrasonic signal.		
	HISTORY	Chronological list of 120 past errors, alarms and warning messages.		
	DELTA TIME FILTERED	Read-only ##.## ns		
	FLOW RATE RAW	Read-only unfiltered flow rate		
	FLUID SOUND SPEED	Read-only; Units are the same as <i>VELOCITY</i> ; Measured ultrasound speed of the fluid.		
	DELTA TIME RAW	Read-only ns		
	REYNOLDS NUMBER	Read-only; unitless; the Reynolds Number based on the fluid viscosity, density, velocity and pipe diameter		
	REYNOLDS FACTOR	Read-only; unitless; the factor applied to the measured flow rate based on the Reynolds Number.		
	TEMPERATURE #1	Read-only; Energy meters only; Units are the same as the <i>Home Screen</i> .		
	TEMPERATURE #2	Read-only; Energy meters only; Units are the same as the <i>Home Screen</i> .		
	DELTA TEMPERATURE	The temperature difference between the two RTDs, either T1 - T2 or T2 - T1, according to the setting in <i>INPUT/OUTPUT > RTD > DELTA TEMP</i> .		
	TOTAL OVERFLOW COUNT	Numeric integer	The <i>TOTAL OVERFLOW COUNT</i> increments each time the flow total exceeds the digits in the display.	
	ENERGY OVERFLOW	Numeric integer	The <i>ENERGY OVERFLOW</i> is a counter that increments each time the energy total exceeds the digits in the display	
INPUT/OUTPUT STATUS	CURRENT #1 OUTPUT	Read-only mA		
	CURRENT #2 OUTPUT	Read-only mA; Energy meters only		
	OUTPUT #1 STATUS	*ON	Status of digital output. If the output mode is <i>ALARM</i> or <i>FLOW DIRECTION</i> , then the output status <i>ON</i> or <i>OFF</i> is indicated. Frequency and Pulse modes can operate too fast to view the <i>ON</i> and <i>OFF</i> state, so the mode is shown for the status.	
		OFF		
		FREQUENCY		
		PULSE		
		DISABLED		
	OUTPUT #2 STATUS	ON	Energy meters only	
		OFF		
		FREQUENCY		
		PULSE		
		DISABLED		
	OUTPUT #3 STATUS	ON	Only with auxiliary contact output option.	
OFF				
FREQUENCY				
PULSE				
DISABLED				
AUX OUTPUT #1 STATUS	ON	Only with auxiliary contact output option.		
	OFF			
	PULSE			
	DISABLED			
	INPUT STATUS			ON OFF
HARDWARE OPTIONS	CARD HARDWARE	NONE BACNET/IP MODBUS TCP/IP ETHERNET/IP DRY CONTACTS	Identifies the hardware type of communication card or contact card installed regardless of the settings	
	MAC ADDRESS	xx:xx:xx:xx:xx:xx	Read only. Ethernet card must be installed and cable must be connected for the <i>MAC Address</i> to display.	
	LINK STATUS	CONNECTED DISCONNECTED	Read only. Ethernet link status if Ethernet card is installed and enabled.	

Diagnosics Submenus	Options/Descriptions		
SYSTEM (Requires service level passcode or higher if security is enabled.)	TIME	HH:MM:SS (24 hour clock)	Displays the time.
	DATE	YYYY-MM-DD	Displays the date.
	POWER ON TIME	In seconds	
	SIMULATION MODE	OFF 100% 90% 80% 70% 60% 50% 40% 30% 20% 10% 0%	<p><i>Flow Simulation</i> provides output and display simulation based on a percentage of the full scale flow. Simulation will not accumulate the totalizers and any digital outputs set to pulse totalizer will not be active. The range of simulation includes 0...100% of the full scale flow.</p> <p>Use the <i>Flow Simulation</i> parameter to set the range of simulation in 10% increments.</p> <p>To change the <i>Flow Simulation</i>, from the <i>INPUTS/OUTPUTS</i> menu:</p> <ol style="list-style-type: none"> 1. Select FLOW SIMULATION to view the <i>Flow Simulation</i> display. 2. Click RIGHT ARROW to increment the percentage by 10, or click DOWN ARROW to decrement the percentage by 10.
	PASSCODE LEVEL	READ ONLY OPERATOR SERVICE ADMIN RECOVERY	Defines the parameters, screens and actions available to a user.
	CLEAR HISTORY	CLEAR HISTORY confirmation screen	Clears all alarms, warnings, errors and informational messages from the <i>ALARM HISTORY</i> buffer. This is typically done after startup or maintenance on the flow system is successfully completed.
	FACTORY RESET	FACTORY RESET confirmation screen	Resets all parameters to the values on the device when it was shipped from the factory. Any settings made will be reset.
REBOOT	REBOOT confirmation screen	Reboots the device. The TFX-5000 meter does not require this manual <i>REBOOT</i> for any procedure, but it may be useful for system troubleshooting.	

Reset Menu

Reset Submenus	Options/Descriptions
RESET FLOW TOTAL	Reset the <i>FLOW TOTAL</i> . See the " Reset Flow Totalizer Procedure " below.
UNLATCH ALARMS	Only available if alarm latch is enabled. Unlatches output if alarm condition occurred and cleared. See " Setup > Inputs/Output > Output #1 (or Output #2 or Output #3) " on page 33.

Reset Flow Totalizer Procedure

The flow meter accumulates the amount of flow passing through the meter into a flow totalizer. To reset the flow total:

1. Press **MENU/BACK**.
2. Select **RESET** from the *Main Menu*.
(Press **DOWN** to scroll through the list of options. When *RESET* is the top item, press **ENTER**.)
3. Select **RESET FLOW TOTAL** from the *Reset menu*.
(With *RESET FLOW TOTAL* as the top item, press **ENTER**.)
4. Select **OK** to confirm reset.

After selecting *RESET FLOW TOTAL*, you are prompted to confirm the reset of the flow total. Press **ENTER** to confirm or press **MENU/BACK** to cancel.

TROUBLESHOOTING

Warning and alarm messages are classified according to NAMUR 107 standards.

Out of Specification Messages

Warning and alarm messages occur when the flow meter is operational, but the readings might be out of specification or an operator might need to take action. If a warning or alarm condition occurs, a warning/alarm icon with code will appear in the at the bottom of the *Home Screen*. The flow rate and flow total will continue to be displayed.

Error Messages

An error condition occurs when the flow rate cannot be determined, such as when the signal strength is too low. If an error condition occurs, the flow rate will be replaced with the "failed" icon, code and description.

If conditions cause multiple messages to occur, all messages will be saved to the history, but some messages may not be displayed. If an error condition occurs, warning and alarm messages will not be displayed. If multiple errors occur, each error message will cycle through and be viewable for 5 seconds. Similarly, if multiple warning or alarm conditions occur (but no error conditions), each message will cycle through and be viewable for 5 seconds.

Warning, Alarm and Error Messages automatically clear when the issue clears.

Check Function Codes

When the meter or outputs are in a test mode, a check function message appears at the bottom of the *Home Screen*.

View Alarm and Message Buffer

Up to 30 alarm or warning message codes are buffered on a first-in-first-out basis. To view the buffer, go to *DIAGNOSTICS > HISTORY*.

Warning and Alarm Message Codes

Failure Codes

Code	Description	Correction
F02 ELECTRONIC ERROR	Multiple watchdog timeouts occurred.	Contact factory
F03 ELECTRONIC ERROR	Voltage levels are out of specification.	Reboot transmitter; If error repeats, repair or replace transmitter.
F10 LOW SIGNAL	Signal strength is below cutoff.	Check for empty pipe, transducer spacing and parameter settings. Check for flow disturbances such as gas/air bubbles, foaming or debris in the liquid. Check for significant scale build in the pipe or detached pipe liners.
F11 HIGH SIGNAL	Signal strength is oversaturated.	Change transducer mounting for more paths.
F20 RTD #1 ERROR	Unable to detect RTD #1.	Check wiring to RTD #1 connector.
F21 RTD #2 ERROR	Unable to detect RTD #2.	Check wiring to RTD #2 connector.

Check Function Codes

Code	Description	Correction
C01 CURRENT TEST	Current output is in test mode.	Change Current Output from Test Mode.
C10 OUTPUT #1 FREQUENCY TEST	Output #1 is in frequency test mode.	Change Output #1 from Test Mode.
C20 OUTPUT #2 FREQUENCY TEST	Output #2 is in frequency test mode.	Change Output #2 from Test Mode.
C30 OUTPUT #3 FREQUENCY TEST	Output #3 is in frequency test mode.	Change Output #3 from Test Mode.
C60 SIMULATION MODE	Meter is running flow simulation.	Deactivate Simulation Mode.

Out-of-Specification Codes

Code	Description	Correction
S01 ELECTRONIC WARNING	Fault detected and meter rebooted.	Contact factory, update firmware, or repair or replace transmitter.
S02 DEFAULT FAILED	Reset to factory defaults failed.	Check calibration. If it does not match the calibration settings on the transducer serial tag, enter field calibration settings. Return to the <i>Home Screen</i> and continue to operate (if the reset to factory defaults is through the transmitter).
S03 LANGUAGE FILE CORRUPT	English only.	Update firmware.

Code	Description	Correction
S10 mA TOO HIGH	Flow or energy rate higher than flow rate at 20 mA output.	Check the scaling of the Current #1 output.
S11 mA TOO HIGH	Flow or energy rate higher than 20 mA.	Check the scaling of the Current #2 output.
S19 mA SUPPLY VOLTAGE ERR	Supply voltage out of range for 4-20 mA outputs.	Check wiring. If the TFX-5000 meter should supply the power to the current output, check that the ISO 24V OUT is jumpered to 4-20 LOOP (TB600 pins 1 & 2).
S20 FREQ HIGH	Value higher than max. frequency output.	Check the scaling of the frequency on Output #1.
S21 FREQ HIGH	Value higher than max. frequency output.	Check the scaling of the frequency on Output #2.
S22 FREQ HIGH	Value higher than max. frequency output.	Check the scaling of the frequency on Output #3.
S30 PULSE HIGH	Pulse output is too fast for the pulse width.	Check the scaling factor, units and pulse width of the pulse on Output #1.
S31 PULSE HIGH	Pulse output is too fast for the pulse width.	Check the scaling factor, units and pulse width of the pulse on Output #2.
S32 PULSE HIGH	Pulse output is too fast for the pulse width.	Check the scaling factor, units and pulse width of the pulse on Output #3.
S33 PULSE HIGH	Pulse output is too fast for the pulse width.	Check the scaling factor, units and pulse width of the pulse on Aux Output #1 dry contact.
S34 PULSE HIGH	Pulse output is too fast for the pulse width.	Check the scaling factor, units and pulse width of the pulse on Aux Output #2 dry contact.
S40 HIGH FLOW	Flow rate is above high flow alarm setting.	Check flow rate and Set High setting for Output #1.
S41 HIGH FLOW	Flow rate is above high flow alarm setting.	Check flow rate and Set High setting for Output #2.
S42 HIGH FLOW	Flow rate is above high flow alarm setting.	Check flow rate and Set High setting for Output #3.
S43 HIGH FLOW	Flow rate is above high flow alarm setting.	Check flow rate and Set High setting for Aux Output #1.
S44 HIGH FLOW	Flow rate is above high flow alarm setting.	Check flow rate and Set High setting for Aux Output #2.
S45 LOW FLOW	Flow rate is below low flow alarm setting.	Check flow rate and Set Low setting for Output #1.
S46 LOW FLOW	Flow rate is below low flow alarm setting.	Check flow rate and Set Low setting for Output #2.
S47 LOW FLOW	Flow rate is below low flow alarm setting.	Check flow rate and Set Low setting for Output #3.
S48 LOW FLOW	Flow rate is below low flow alarm setting.	Check flow rate and Set Low setting for Aux Output #1.
S49 LOW FLOW	Flow rate is below low flow alarm setting.	Check flow rate and Set Low setting for Aux Output #2.
S50 TOTAL OVERFLOW	Accumulated flow total is greater than viewable digits.	Check the totalizer units or reset the flow total to clear the overflow counter.
S60 COMM TIMEOUT	Modbus master or BACnet device communication packet.	Check master device poll rate and offline status. Check wiring and termination resistor setting. Check Setup > Communication > Modbus RTU Config (or BACnet MS/TP Config) > Timeout parameter setting.
S61 MODULE TIMEOUT	Network timeout.	Check communication settings and wiring of the Ethernet card.
S62 DISCONNECTED	Bluetooth connection timed out.	—
S63 BLUETOOTH FAIL	Unable to initialize Bluetooth.	Update firmware. If error repeats, repair or replace transmitter.
S64 MODULE FAILED	Unable to initialize module.	Reseat module and reboot transmitter. Check card type detection matches the installed card or is set to autodetect. If error repeats, replace module.
S65 MODULE MISMATCH	Module installed does not match settings.	Replace module with correct module. Check card type settings.
S67 DATA LOG ERROR	microSD card is missing or full.	Check microSD card. If data logging is not required, disable data logging.
S70 TEMP #1 LOW	Temp. #1 is below low alarm setting.	Check fluid temperature and RTD #1. Check alarm settings for Output #1.
S71 TEMP #1 LOW	Temp. #1 is below low alarm setting.	Check fluid temperature and RTD #1. Check alarm settings for Output #2.
S72 TEMP #1 LOW	Temp. #1 is below low alarm setting.	Check fluid temperature and RTD #1. Check alarm settings for Output #3.
S73 TEMP #1 LOW	Temp. #1 is below low alarm setting.	Check fluid temperature and RTD #1. Check alarm settings for Aux Output #1.
S74 TEMP #1 LOW	Temp. #1 is below low alarm setting.	Check fluid temperature and RTD #1. Check alarm settings for Aux Output #2.
S75 TEMP #1 HIGH	Temp. #1 is above high alarm setting.	Check fluid temperature and RTD #1. Check alarm settings for Output #1.
S76 TEMP #1 HIGH	Temp. #1 is above high alarm setting.	Check fluid temperature and RTD #1. Check alarm settings for Output #2.
S77 TEMP #1 HIGH	Temp. #1 is above high alarm setting.	Check fluid temperature and RTD #1. Check alarm settings for Output #3.
S78 TEMP #1 HIGH	Temp. #1 is above high alarm setting.	Check fluid temperature and RTD #1. Check alarm settings for Aux Output #1.
S79 TEMP #1 HIGH	Temp. #1 is above high alarm setting.	Check fluid temperature and RTD #1. Check alarm settings for Aux Output #2.
S80 HIGH ENERGY RATE	Flow rate is above high flow alarm setting.	Check energy flow rate and Set High setting for Output #1.
S81 HIGH ENERGY RATE	Flow rate is above high flow alarm setting.	Check energy flow rate and Set High setting for Output #2.
S82 HIGH ENERGY RATE	Flow rate is above high flow alarm setting.	Check energy flow rate and Set High setting for Output #3.
S83 HIGH ENERGY RATE	Flow rate is above high flow alarm setting.	Check energy flow rate and Set High setting for Aux Output #1.
S84 HIGH ENERGY RATE	Flow rate is above high flow alarm setting.	Check energy flow rate and Set High setting for Aux Output #2.
S85 LOW ENERGY RATE	Flow rate is above low flow alarm setting.	Check energy flow rate and Set Low setting for Output #1.
S86 LOW ENERGY RATE	Flow rate is above low flow alarm setting.	Check energy flow rate and Set Low setting for Output #2.
S87 LOW ENERGY RATE	Flow rate is above low flow alarm setting.	Check energy flow rate and Set Low setting for Output #3.
S88 LOW ENERGY RATE	Flow rate is above low flow alarm setting.	Check energy flow rate and Set Low setting for Aux Output #1.
S89 LOW ENERGY RATE	Flow rate is above low flow alarm setting.	Check energy flow rate and Set Low setting for Aux Output #2.
S90 TEMP #2 LOW	Temp. #2 is below low alarm setting.	Check fluid temperature and RTD #2. Check alarm settings for Output #1.
S91 TEMP #2 LOW	Temp. #2 is below low alarm setting.	Check fluid temperature and RTD #2. Check alarm settings for Output #2.
S92 TEMP #2 LOW	Temp. #2 is below low alarm setting.	Check fluid temperature and RTD #2. Check alarm settings for Output #3.
S93 TEMP #2 LOW	Temp. #2 is below low alarm setting.	Check fluid temperature and RTD #2. Check alarm settings for Aux Output #1.
S94 TEMP #2 LOW	Temp. #2 is below low alarm setting.	Check fluid temperature and RTD #2. Check alarm settings for Aux Output #2.
S95 TEMP #2 HIGH	Temp. #2 is above high alarm setting.	Check fluid temperature and RTD #2. Check alarm settings for Output #1.
S96 TEMP #2 HIGH	Temp. #2 is above high alarm setting.	Check fluid temperature and RTD #2. Check alarm settings for Output #2.
S97 TEMP #2 HIGH	Temp. #2 is above high alarm setting.	Check fluid temperature and RTD #2. Check alarm settings for Output #3.
S98 TEMP #2 HIGH	Temp. #2 is above high alarm setting.	Check fluid temperature and RTD #2. Check alarm settings for Aux Output #1.
S99 TEMP #2 HIGH	Temp. #2 is above high alarm setting.	Check fluid temperature and RTD #2. Check alarm settings for Aux Output #2.

Informational Events Codes

Information events are only displayed in the ALARM HISTORY and not on the *Home Screen*.

Code	Description
I01 POWER ON	Power on or rebooted.
I11 ZERO	Meter zeroed.
I12 FACTORY CALIBRATION	Calibration changed from Field to Factory.
I13 FIELD CALIBRATION	Calibration changed from Factory to Field.
I21 FIRMWARE CHANGED	Firmware updated or parameters set to factory defaults.
I31 FLOW TOTAL RESET	Flow total reset to zero.
I41 NO SD CARD	MicroSD card not installed.

Symptoms

Symptom: Transmitter does not power up.

Possible Causes	Recommended Action
<ul style="list-style-type: none"> No power or inadequate power Blown fuse (AC Model only) Display ribbon cable not seated properly 	<ul style="list-style-type: none"> Measure voltage at the power terminals and check that the voltage matches the labels by the power terminals. Check the fuse near the power terminals. If fuse is blown, verify the voltage and polarity is correct and reset the fuse. Inspect ribbon cable connections. LEDs on power board will light up with no LCD display. Replace the transmitter if the above actions do not resolve the issue.

Symptom: Flow reading appears to be incorrect.

Possible Causes	Recommended Action
<ul style="list-style-type: none"> Incorrect positioning of transducers Poor contact between transducers and pipe Poor placement of transducers Low signal strength Process loop issues Incorrect pipe settings Meter not calibrated Display not set up correctly 	<p>Refer to the Transducer Mounting Configuration section for details on proper installation.</p> <p>At the transducer:</p> <ul style="list-style-type: none"> Verify that the spacing of the transducers is set correctly. On most transducers, a scribe mark on the side of the transducers indicates the point of measurement—NOT from the end points of the transducers. Verify that the transducers are aligned correctly. For Z-Mount, verify the transducers are 180° from each other. Make sure there is a good contact between the transducers and pipe and a thin coat of acoustic coupling is applied. For integral mount, check for over-tightening of the transducers. <p>Process loop and general location:</p> <ul style="list-style-type: none"> Make sure the transducers are on the sides of the pipe and NOT on the top of the pipe. Check that the transducers are NOT located at the highest point in the loop where air may accumulate. Check that the transducers are NOT on a downward flowing pipe unless adequate downstream head pressure is present to overcome partial filling or cavitation. Check that the transducers have adequate straight pipe upstream and downstream. Check process loop for entrained air or particulates which will impact the flow readings. Pipes may develop scale, product build-up or corrosion over time. As a result, the effective wall thickness may be different than a new pipe and wall thickness or liner parameters may need to be adjusted. <p>At the transmitter:</p> <ul style="list-style-type: none"> Verify that pipe parameters match the installation.

Symptom: Unstable flow.

Possible Causes	Recommended Action
<ul style="list-style-type: none"> Installation issues Flow instability Transducer mounting is loose Transducers are moved Incorrect flow settings 	<ul style="list-style-type: none"> Check process loop for variations of entrained air which will impact the flow Check for pump induced flow instability. Check that the transducers are secure and are in area where the transducers will not be inadvertently bumped or disturbed. Check low flow cutoff, minimum flow or maximum flow settings.

Symptom: Flow readout is opposite of the flow direction.

Possible Causes	Recommended Action
<ul style="list-style-type: none"> • Integral mount transmitter is mounted in reverse flow direction so display is properly oriented • Up and down transducers wiring is reversed • Flow direction parameter is reversed 	<ul style="list-style-type: none"> • Change the transducer flow direction parameter. • Rewire the up and down transducers to the transmitter.

Symptoms: Current, frequency or pulse outputs do not match the readings.

Possible Causes	Recommended Action
<ul style="list-style-type: none"> • Incorrect parameter settings • Wiring or control system configuration issues 	<p>Verify that the parameters for the output are set properly.</p>

REPLACEMENT PROCEDURES

⚠ WARNING

DISCONNECT POWER BEFORE OPENING THE ENCLOSURE.

Tools Required

- A Phillips #2 screwdriver
- A flat blade screwdriver
- Tweezers for electronics
- A workbench that prevents ESD damage to the electronics

⚠ CAUTION

CONTAINS PARTS AND ASSEMBLIES SUSCEPTIBLE TO DAMAGE BY ELECTROSTATIC DISCHARGE (ESD). BEFORE PICKING UP AN ESD-SENSITIVE ELECTRONIC COMPONENT, DISCHARGE YOURSELF BY TOUCHING A GROUNDED BARE METAL SURFACE OR APPROVED ANTI-STATIC MAT.



OBSERVE PRECAUTIONS FOR HANDLING ELECTROSTATIC-SENSITIVE DEVICES.

Replacing an AC Module

1. Turn off the power.
2. Open the enclosure.
3. Unplug the DC power wire connector from the terminal block on the main board.
4. Remove (2) M3 pan head phillips screws that secure the cover over the AC power terminal block.
5. Unplug the wire connector from the terminal block on the AC module.
6. Remove the remaining (4) M3 pan head phillips screws and lock washers that secure the AC module to the enclosure base.
7. Remove the AC module.

Installation is in the reverse order.

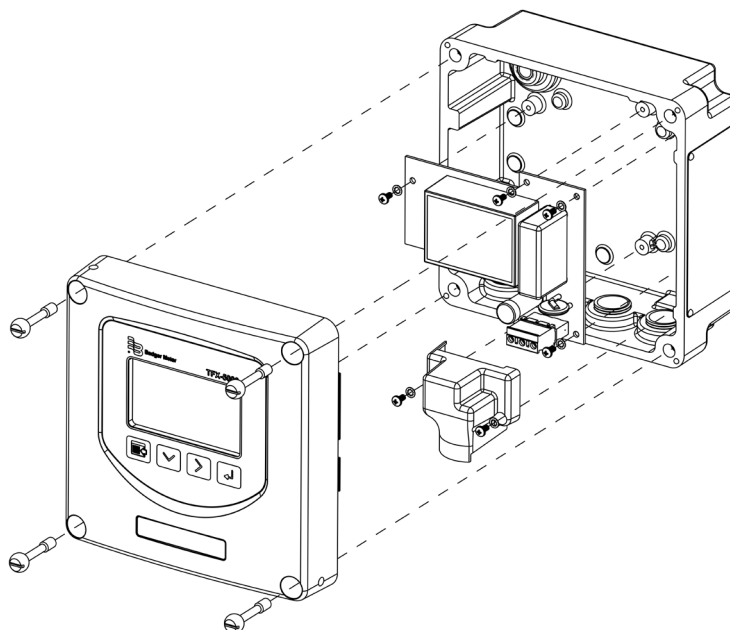

Figure 44: Replacing an AC module

Replacing the Communication or Dry Contact Board

1. Turn off the power.
2. Open the enclosure.
3. Disconnect the wires from the communication board.
4. Remove (2) M3 pan head phillips screws that secure the cover over the communication board.
5. Remove the cover.
6. Remove the remaining (2) M3 pan head phillips screws that secure the communications board.
7. Lift the communications board straight out to unplug from the main board.

Installation is in reverse order, noting the following. To install a new communications board, align the pins with the header on the main board and gently press straight down. Do not misalign the pins. Do not use excessive force.

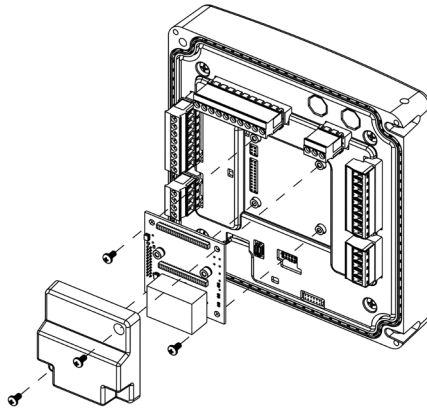

Figure 45: Replacing the Communication or Dry Contact Board

Replacing the Main Board

1. Turn off the power.
2. Open the enclosure.
3. Remove the terminal blocks from the header on the main board.
4. If a communications board is present, remove it.
5. Remove the (4) M4 pan head phillips screws that secure the main board and shield.
6. Lift the shield off the main board.
7. Gently pull the main board straight out to disengage it from the display header and remove it from the enclosure lid.

Installation is in reverse order, noting the following. To install a new main board, align the pins on the display header with the socket on the main board and gently press straight down. Be careful not to misalign the pins. Do not use excessive force.

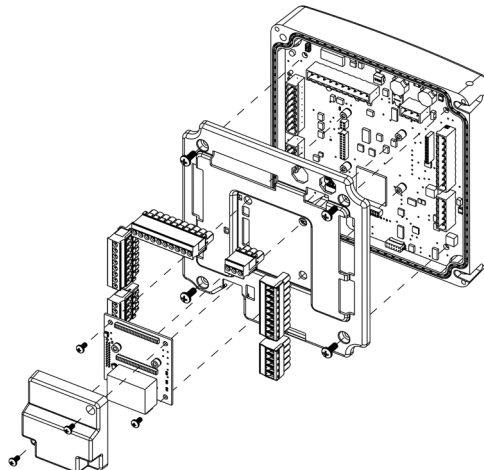

Figure 46: Replacing the Communication or Dry Contact Board

Firmware Update

Firmware can be updated using SoloCUE Flow Device Manager software. Parameter and calibration settings will not be overwritten unless there is a conflict with the new parameters. Back up the device configuration prior to updating the firmware. See "TFX-5000 Firmware Update" (available at www.badgermeter.com) for more information.

SPECIFICATIONS

System

Liquid Types	Most clean liquids or liquids containing small amounts of suspended solids or gas bubbles	
Flow Accuracy	Medium Pipes (JZ, KZ, NZ, RZ, WZ, HZ)	$\pm 0.5\% \pm 0.025$ ft/s (0.008 m/s) of reading
	Large Pipes (LZ, YZ)	$\pm 0.5\% \pm 0.049$ ft/s (0.015 m/s) of reading
	Small Pipes (CA-CT, UZ)	1 in. (25 mm) and larger = $\pm 1\% \pm 0.03$ ft/s (0.009 m/s) of reading 3/4 in. (20 mm) and smaller = $\pm 1\%$ of full scale
Repeatability	0.2% above 1.5 ft/s	
Velocity	Medium and Large Pipes	Up to 40 ft/s, depending on pipe and fluid
	Small Pipes	Up to 20 ft/s, depending on pipe and fluid
Straight Run Requirements	10 diameters upstream, 5 diameters downstream from single elbow	
Certification and Compliance	<p>General Safety (all models): cCSAus; CE, Pollution Degree 2, CE compliance to Low Voltage Directive, 2014/35/EU; UKCA, Pollution Degree 2, UKCA compliance to Low Voltage Statutory Instrument 2016/1101</p> <p>U.S./Canada Hazardous Location transmitter and transducers: Transmitter and transducers (certification option B): cCSAus Class I Division 2 Groups ABCD T4 Requires flexible conduit Not available with UZ, HZ or JZ and KZ (Easy Rail) transducers, Auxiliary Dry Contact card or units with AquaCUE/BEACON endpoints</p> <p>Transmitter (certification option R): cCSAus Ex ec ic nC IIC T4 Gc; Ex tc IIIB T100° C Dc; Class I, Zone 2, AEx ec ic nC IIC T4 Gc; Zone 22, AEx tc IIIB T100° C Dc; Class II, Division 2, Groups FG; Class III Not available with Auxiliary Dry Contact card or units with AquaCUE/BEACON endpoints</p> <p>Transducers RZ LZ, NZ, RZ, WZ, YZ (certification option R): cCSAus Ex ec IIC T6 Gc; Ex tc IIIB T60° C Dc; Class I, Zone 2, AEx ec IIC T6 Gc; Zone 22, AEx tc IIIB T60° C Dc; Class II, Division 2, Groups FG; Class III Requires flexible conduit Not available with CA-CT, UZ, HZ or JZ and KZ (Easy Rail) transducers</p> <p>ATEX Hazardous Location: Transmitter (certification option V): II 3 G D Ex ec ic nC IIC T4 Gc, Ex tc IIIB T100° C Dc; Tamb: -25...60° C JZ (DTTJ), KZ (DTTK), LZ (DTTL), NZ (DTTN) and RZ (DTTR) Transducers: II 3 G D Ex ec IIC T6 Gc; Ex tc IIIB T60° C Dc; Tamb: -25...60° C Not available with UZ, CA to CT, or HZ transducers; flexible conduit, Auxiliary Dry Contact card or AquaCUE/BEACON endpoints</p> <p>UKEX Hazardous Location: Transmitter (certification option V): II 3 G D Ex ec ic nC IIC T4 Gc, Ex tc IIIB T100° C Dc; Tamb: -25...60° C JZ (DTTJ), KZ (DTTK), LZ (DTTL), NZ (DTTN) and RZ (DTTR) Transducers: II 3 G D Ex ec IIC T6 Gc; Ex tc IIIB T60° C Dc; Tamb: -25...60° C Not available with UZ, CA to CT, or HZ transducers; flexible conduit, Auxiliary Dry Contact card or AquaCUE/BEACON endpoints</p> <p>IECEx Hazardous Location: Transmitter (certification option V): Ex ec nC ic IIC T4 Gc; Ex tc IIIC T100° C Dc; Tamb: -25°C...60° C JZ, KZ, LZ, NZ and RZ Transducers: Ex ec IIC T6 Gc; Ex tc IIIB T60° C Dc; Tamb: -25...60° C Not available with UZ, CA to CT, or HZ transducers; flexible conduit, Auxiliary Dry Contact card or AquaCUE/BEACON endpoints</p>	

Transmitter

Power Options	24V DC/AC	9...28V DC @ 8 W max. or 20...26 AC 47...63 Hz @ 0.5 A max., 2 Amp slow-blow fuse, not field replaceable
	Mains AC	85...264V AC 47...63 Hz @ 24VA max. 1 Amp slow-blow fuse, manually field replaceable Over-Voltage Rating Category II (CAT II)
Display	Options	Display with keypad or no display/keypad
	Keypad	4-button navigation, keypad with tactile feedback; polyester film
	Display	128 × 64 pixel LED backlit graphical display; adjustable brightness and timeout; polycarbonate window
	Flow rate/total	8-digit
Enclosure	NEMA Type 4X, IP67	
Construction	Aluminum construction; painted; wall, panel or pipe mounting; stainless steel fasteners and mounting hardware; EPDM gasket	
	Conduit Holes	(4) 1/2 in. NPT, M20 × 1.5 or 1/2 BSPP; cable glands available for NPT and M20
Environmental Ratings	Pollution Degree	2
	Altitude Restriction	Up to 2000 m (6561 ft)
	Ambient Temperature Range	-4...140° F (-20...60° C)
	Storage Temperature Range	-40...176° F (-40...80° C)
	Humidity	0...85%, non-condensing
Configuration	Via optional keypad or SoloCUE configuration software; SoloCUE available on DVD or download	
Units (Field-Selectable)	Velocity	feet/second, meters/second
	Volumetric total	US Gallons, Million Gallons, Imperial Gallons, Million Imperial Gallons, Acre-Feet, Liters, Hectoliters, Cubic Meters, Cubic Feet, Oil Barrels (42 gallons), Fluid Barrels (31.5 gallons), Imperial Fluid Barrels (36 imperial gallons), Pounds (Kilograms) and custom units
	Flow rate	Acre Feet/Day, Liters/Second, Liters/Minute, Liters/Hour, Cubic Meters/Second, Cubic Meters/Minute, Cubic Meters/Hour, Cubic Feet/Minute, Cubic Feet/Hour, Gallons/Second, Gallons/Minute, Gallons/Hour, Million Gallons/Day, Imperial Gallons/Second, Imperial Gallons/Minute, Imperial Gallons/Hour, Million Imperial Gallons/Day, Oil Barrels/Day, Fluid Barrels/Day, Imperial Fluid Barrels/Day and custom units
	Energy total (energy meters)	British Thermal Unit (Btu), Thousand Btu, Millions Btu, Kilocalories, Mega calories, Kilowatt-hour, Megawatt hour, Kilojoules, Mega joules, Ton-hour (Refrigeration)
	Heat/cooling rate (energy meters)	Btu/hour, Thousand Btu/hour, Millions Btu/hour, Ton (Refrigeration), Watts, Kilowatts, Megawatts, Kilojoules/hour, Mega joules/hour, Kilocalories/hour, Mega calories/hour
	Temperature (energy meters)	Fahrenheit, Celcius, Kelvin

		Flow Meter	Energy Meter
Inputs and Outputs	0/4...20 mA output	One 16-bit, isolated, max 800 Ohms, internal or external power	Two 16-bit, isolated, max 800 Ohms, internal or external power
	Digital input	One 5...30V DC, isolated, externally or internally sourced, reset totalizer or alarm output	
	Digital output	Two selectable pulse, alarm, flow direction, sink isolated open collector, 5...30V DC, max. 50 mA externally or internally sourced, leakage current 1uA max.	
		Frequency output: 50% duty cycle, 63...10k Hz maximum frequency	
		Pulse (totalizer) output: Open collector, pulse width 1...500 ms programmable	
		Optional: Two dry contact output for alarm or flow direction 30V DC max., 5A max. (Ethernet not available with this option)	
RTD (energy only)	None	Two 2-wire, 3-wire or 4-wire Pt100/Pt1000 RTD 12-bit inputs; Range of -40...200° C; Clamp-on resistor kits available	
Ports	Programming	USB 2.0 mini B connector for connection to a device with SoloCUE configuration software	
	EIA-485	Modbus RTU command set or BACnet MS/TP; Baud rates 9600, 14400, 19200, 38400, 57600, 76800, 115k; terminating resistor selectable	
	Ethernet	Optional 10/100 Base T RJ45, communication via Modbus TCP/IP, BACnet/IP or EtherNet/IP	
	AquaCUE/BEACON	Connectivity to AquaCUE/BEACON endpoint (LTE cellular)	
Data Logging	Number of points	Up to 8 parameters per record. Selectable 1 second to 1 day Transfer logs via memory card	
	Real Time Clock	Backed up with a super capacitor, minimum of 32 days of data retention without power; Requires no servicing	
	MicroSD card slot	8 GB card, included with transmitter	
Alarms	Records 150 previous alarms, warnings or errors		
Languages	English, French, German, Italian, Spanish		
Security	Four levels: Read-only, Operator, Service and Admin; 6-digit passcode number; selectable auto logout		

Transducers

Model	Construction	Cable Length Max.	Pipe/Tubing Sizes ¹	Flow Rate Max. GPM (LPM)	Pipe/Tubing Materials
CA-CT ⁵ fixed small pipe	CPVC, Ultem®, Nylon cord grip, PVC cable jacket; -40...194° F	100 ft	0.5...2 in.	190	See ²
UZ adjustable small pipe	CPVC, Ultem, and anodized aluminum track system; Nickel-plated brass connector with Teflon insulation; PVC cable jacket; -40...194° F (-40...90° C)	100 ft (30 m)	0.5...2 in. (12...50 mm)	190 (720)	
NZ (IP67) standard pipe	CPVC, Ultem®, Nylon cord grip, PVC cable jacket; -40...194° F (-40...90° C)	300 ft (90 m)	2.5...12 in. (DN65...DN300)	4000 (15,000)	
RZ (IP54) standard pipe	PBT glass filled, Ultem®, Nylon cord grip; PVC cable jacket; -40...250° F (-40...121° C)	300 ft (90 m)	2.5...12 in. (DN65...DN300)	4000 (15,000)	
JZ, KZ (IP54) standard pipe, integrated rail	PBT glass filled, Ultem, Nylon cord grip; PVC cable jacket; -40...250° F (-40...121° C)	300 ft (90 m)	2.5...6 in. (DN65...DN150) 2.5...12 in. (DN65...DN300)	4000 (15,000)	
WZ (IP68) ⁷ standard pipe, submersible	CPVC, Ultem, Nylon cord grip; Polyethylene cable jacket; -40...194° F (-40...90° C)	300 ft (90 m)	2.5...12 in. (DN65...DN300)	4000 (15,000)	
HZ high temperature	PTFE, Vespel, Nickel-plated brass cord grip; FEP cable jacket; -40...350° F (-40...176° C)	300 ft (90 m)	2.5...12 in. (DN65...DN300)	4000 (15,000)	
LZ (IP67) large pipe	CPVC, Ultem, Nylon cord grip PVC cable jacket; -40...194° F (-40...90° C)	300 ft (90 m) ⁶	8...48 in. (DN200...DN1200) ^{3,4}	33,000 (125,000)	
YZ (IP68) ⁷ large pipe, submersible	CPVC, Ultem, Nylon cord grip; Polyethylene cable jacket; -40...194° F (-40...90° C)	300 ft (90 m) ⁶	8...48 in. (DN200...DN1200) ^{3,4}	33,000 (125,000)	

¹ Recommendations based on unlined, new pipes with water. Recommended pipe or tubing sizes vary with pipe conditions and fluid.

² PVC, CPVC, HDPE, PTFE, PDVF, stainless steel, ductile iron, aluminum, brass naval, carbon steel copper.

³ Large pipe transducers are recommended for 8...12 in. pipes if normal velocity is expected to be greater than 12 ft/s (3.6 m/s).

⁴ Consult factory for larger pipe sizes.

⁵ Not for metric pipes.

⁶ Cable lengths up to 600 ft are available. Consult factory for lead times.

⁷ IP68 tested at 1 meter for 24 hours.

RTD Kits

Part Number	Description	Installation	RTD Type	Construction	Temperature Range
68996-001	RTD pair; 15 ft (4.5 m) cable	Pipe clamp, surface mount, IP54	Pt 1000, Class A $\pm (0.15 + 0.002 * t)$ with t as temperature °C	Aluminum body, silicone cable jacket	-58...356° F (-50...180° C)
68996-002	RTD pair; 50 ft (15 m) cable				
68996-003	RTD pair; 100 ft (30 m) cable				

SoloCUE Flow Device Manager Software

The flow meter *may* be programmed through the keypad or with SoloCUE software. If the meter is ordered without a display/keypad, the flow meter *must* be programmed with SoloCUE software. The software is used to configure, calibrate and communicate with TFX-5000 meters with English, French, German, Italian and Spanish menus. Additionally, it has numerous troubleshooting tools to make diagnosing and correcting installation problems easier.

SoloCUE	Used to configure, calibrate and troubleshoot flow meters and control valves; Software is compatible with Windows 7, 8, 10
USB Cable	RC820648 USB 2.0 mini B connector to A connector, shielded

PART NUMBER CONSTRUCTION

TFX-5000 Flow Meters for Pipes 2 in. and Smaller

[DQ] - [G] - [] - [] - [] - [] - [] - [] - [XX] - [] - [] - []

Model

TFX-5000 Ultrasonic Clamp-On Meter

DQ

Certification

General Area US/Canada, CE

G

Transducer Type¹

1/2 inch ANSI Pipe

CA

3/4 inch ANSI Pipe

CB

1 inch ANSI Pipe

CC

1-1/4 inch ANSI Pipe

CD

1-1/2 inch ANSI Pipe

CE

2 inch ANSI Pipe

CF

1/2 inch Copper Tube

CG

3/4 inch Copper Tube

CH

1 inch Copper Tube

CT

1-1/4 inch Copper Tube

CJ

1-1/2 inch Copper Tube

CK

2 inch Copper Tube

CL

Small pipe, universal, DTTSU (not available with conduit) UZ

Transmitter Type

110/220V AC Remote Mounted

R

24V DC/AC Remote Mounted

B

Display

Display and Keypad

S

No Display/Keypad

W

Remote Cable Length

15 feet (4.5 m)

AC

30 feet (9 m)

AF

50 feet (15 m)

AK

75 feet (23 m)

AR

100 feet (30 m)

BW

Conduit Type and Length (Conduit length is less than or equal to cable length)

None

WW

5 feet (1.5 m)

AA

15 feet (4.5 m)

AC

30 feet (9 m)

AF

50 feet (15 m)

AK

75 feet (23 m)

AR

100 feet (30 m)

BW

Hardware

1/2 in. NPT Threads, Poly cable glands

S

1/2 in. NPT Threads, Nickel Plated Brass cable glands

T

1/2 in. NPT Threads, no cable glands

N

M20 Threads, Poly cable glands

C

M20 Threads, Nickel Plated Brass cable glands

D

M20 Threads, no cable glands

A

Endpoint Wiring Method

None

XX

Communication/Output

Standard Output (Modbus RTU or BACnet MS/TP field selectable)

S

Standard Output plus Modbus TCP Ethernet

T

Standard Output plus BACnet/IP Ethernet

V

Standard Output plus EtherNet/IP

U

Standard Output plus Aux Output

9

Units of Measure Totalizer/Flow Rate²

Gallons/gallons per minute

G

Liters/liters per minute

P

Testing & Tagging

Factory Calibrated

F

Factory Calibrated/Stainless Steel Tag

S

¹ Stainless steel tube 1/2...2 in. options are available.

² Field selectable, additional options available.

TFX-5000 Flow Meters for Pipes 2 in. and Smaller for Class I, Div 2 Hazardous Locations

	DQ	B							XX			
Model	TFX-5000 Ultrasonic Clamp-On Meter	DQ										
Certification	Hazardous Location, Class I, Division 2	B										
Transducer Type¹	1/2 inch ANSI Pipe	CA										
	3/4 inch ANSI Pipe	CB										
	1 inch ANSI Pipe	CC										
	1-1/4 inch ANSI Pipe	CD										
	1-1/2 inch ANSI Pipe	CE										
	2 inch ANSI Pipe	CF										
	1/2 inch Copper Tube	CG										
	3/4 inch Copper Tube	CH										
	1 inch Copper Tube	CT										
	1-1/4 inch Copper Tube	CJ										
	1-1/2 inch Copper Tube	CK										
	2 inch Copper Tube	CL										
Transmitter Type	110/220V AC Remote Mounted											R
	24V DC/AC Remote Mounted											B
Display	Display and Keypad											S
	No Display/Keypad											W
Remote Cable/Conduit Length²	15 feet (4.5 m)											AC
	30 feet (9 m)											AF
	50 feet (15 m)											AK
	75 feet (23 m)											AR
	100 feet (30 m)											BW
Hardware	1/2 in. NPT Threads, Poly cable glands											S
	1/2 in. NPT Threads, Nickel Plated Brass cable glands											T
	1/2 in. NPT Threads, no cable glands											N
	M20 Threads, Poly cable glands											C
	M20 Threads, Nickel Plated Brass cable glands											D
	M20 Threads, no cable glands											A
Endpoint Wiring Method	None											XX
Communication/Output	Standard Output (Modbus RTU or BACnet MS/TP field selectable)											S
	Standard Output plus Modbus TCP Ethernet											T
	Standard Output plus BACnet/IP Ethernet											V
	Standard Output plus EtherNet/IP											U
Units of Measure Totalizer/Flow Rate³	Gallons/gallons per minute											G
	Liters/liters per minute											P
Testing & Tagging	Factory Calibrated											F
	Factory Calibrated/Stainless Steel Tag											S

¹Stainless steel tube 1/2...2 in. options are available.

²For hazardous location units, Remote Cable and Conduit Length codes must match.

³Field selectable, additional options available.

TFX-5000 Flow Meters for Pipes 2.5 in. and Larger

	DQ	G								XX			
Model	TFX-5000 Ultrasonic Clamp-On Meter												
Certification	General Area US/Canada, CE												
Transducer Type	Medium pipe, DTTR, 2.5 in. (65 mm) or larger RZ Medium pipe, submersible DTTN, 2.5 in. (65 mm) or larger ¹ WZ 2.5...6 inches (65...150 mm) Easy Rail (not available with conduit) JZ 2.5...12 inches (65...300 mm) Easy Rail (not available with conduit) KZ Medium pipe, high temperature (not available with conduit) HZ Large pipe, DTTL, 8 in. (200 mm) or larger LZ Large pipe, submersible DTTL, 8 in. (200 mm) or larger ¹ YZ												
Transmitter Type	110/220V AC Remote Mounted R 24V DC/AC Remote Mounted B												
Display	Display and Keypad S No Display/Keypad W												
Remote Cable Length	15 feet (4.5 m) AC 30 feet (9 m) AF 50 feet (15 m) AK 75 feet (23 m) AR 100 feet (30 m) BW 150 feet (46 m) BK 200 feet (61 m) DW 250 feet (76 m) DK 300 feet (90 m) EW 350 feet (107 m) (DTTL "LZ" and "YZ" only) EK 400 feet (122 m) (DTTL "LZ" and "YZ" only) FW 450 feet (137) (DTTL "LZ" and "YZ" only) FK 500 feet (152 m) (DTTL "LZ" and "YZ" only) GW 550 feet (168) (DTTL "LZ" and "YZ" only) GK 600 feet (183 m) (DTTL "LZ" and "YZ" only) HW												
Conduit Type and Length (Conduit length is less than or equal to cable length)	None WW 5 feet (1.5 m) AA 15 feet (4.5 m) AC 30 feet (9 m) AF 50 feet (15 m) AK 75 feet (23 m) AR 100 feet (30 m) BW 150 feet (46 m) BK 200 feet (61 m) DW 250 feet (76 m) DK 300 feet (90 m) EW												
Hardware	1/2 in. NPT Threads, Poly cable glands S 1/2 in. NPT Threads, Nickel Plated Brass cable glands T 1/2 in. NPT Threads, no cable glands N M20 Threads, Poly cable glands C M20 Threads, Nickel Plated Brass cable glands D M20 Threads, no cable glands A												
Endpoint Wiring Method	None XX												
Communication/Output	Standard Output (Modbus RTU or BACnet MS/TP field selectable) S Standard Output plus Modbus TCP Ethernet T Standard Output plus BACnet/IP Ethernet V Standard Output plus EtherNet/IP U Standard Output plus Aux Output 9												
Units of Measure Totalizer/Flow Rate²	Gallons/gallons per minute G Liters/liters per minute P												
Testing & Tagging	Factory Calibrated F Factory Calibrated/Stainless Steel Tag S												

¹ Submersible transducer cables use two conduit openings.

² Field selectable, additional options available.

TFX-5000 Flow Meters for Pipes 2.5 in. and Larger for U.S./Canada Hazardous Locations

	DQ								XX			
Model												
TFX-5000 Ultrasonic Clamp-On Meter	DQ											
Certification												
Hazardous Location, Class I, Division 2		B										
Hazardous Location Class I, Div 2, Zone 2/22; Class		R										
Transducer Type												
Medium pipe, DTTR, 2.5 in. (65 mm) or larger											RZ	
Medium pipe, submersible DTTN, 2.5 in. (65 mm) or larger ¹											WZ	
Large pipe, DTTL, 8 in. (200 mm) or larger											LZ	
Large pipe, submersible DTTL, 8 in. (200 mm) or larger ¹											YZ	
Transmitter Type												
110/220V AC Remote Mounted											R	
24V DC/AC Remote Mounted											B	
Display												
Standard											S	
No Display/Keypad											W	
Remote Cable/Conduit Length												
15 feet (4.5 m)											AC	AC
30 feet (9 m)											AF	AF
50 feet (15 m)											AK	AK
75 feet (23 m)											AR	AR
100 feet (30 m)											BW	BW
150 feet (46 m)											BK	BK
200 feet (61 m)											DW	DW
250 feet (76 m)											DK	DK
300 feet (90 m)											EW	EW
Hardware												
1/2 in. NPT Threads, Poly cable glands											S	
1/2 in. NPT Threads, Nickel Plated Brass cable glands											T	
1/2 in. NPT Threads, no cable glands											N	
M20 Threads, Poly cable glands											C	
M20 Threads, Nickel Plated Brass cable glands											D	
M20 Threads, no cable glands											A	
Endpoint Wiring Method												
None											XX	
Communication/Output												
Standard Output (Modbus RTU or BACnet MS/TP field selectable)											S	
Standard Output plus Modbus TCP Ethernet											T	
Standard Output plus BACnet/IP Ethernet											V	
Standard Output plus EtherNet/IP											U	
Units of Measure Totalizer/Flow Rate ²												
Gallons/gallons per minute											G	
Liters/liters per minute											P	
Testing & Tagging												
Factory Calibrated											F	
Factory Calibrated/Stainless Steel Tag											S	

¹ Submersible transducer cables use two conduit openings.

² Field selectable, additional options available.

TFX-5000 Flow Meters for Pipes Larger than 2 in. for ATEX/IECEx Hazardous Locations

DQ - [] - [] - [] - [] - [] - [] - [] - XX - [] - [] - []

Model		DQ											
TFX-5000 Ultrasonic Clamp-On Meter		DQ											
Certification													
Hazardous Location, ATEX Zone 2/22, IECEx Zone 2, UKEX V													
Transducer Type													
Medium pipe, DTRR, 2.5 in. (65 mm) or larger													RZ
Medium pipe, submersible DTTN, 2.5 in. (65 mm) or larger ¹													WZ
2.5...6 inches (65...150 mm) Easy Rail (not available with conduit)													JZ
2.5...12 inches (65...300 mm) Easy Rail (not available with conduit)													KZ
Large pipe, DTTL, 8 in. (200 mm) or larger													LZ
Large pipe, submersible DTTL, 8 in. (200 mm) or larger ¹													YZ
Transmitter Type													
110/220V AC Remote Mounted													R
24V DC/AC Remote Mounted													B
Display													
Display and Keypad													S
No Display/Keypad													W
Remote Cable Length													
15 feet (4.5 m)													AC
30 feet (9 m)													AF
50 feet (15 m)													AK
75 feet (23 m)													AR
100 feet (30 m)													BW
150 feet (46 m)													BK
200 feet (61 m)													DW
250 feet (76 m)													DK
Conduit Type and Length (Conduit length is less than or equal to cable length)													
None													WW
Hardware													
1/2 in. NPT Threads, Poly cable glands													S
1/2 in. NPT Threads, Nickel Plated Brass cable glands													T
1/2 in. NPT Threads, no cable glands													N
M20 Threads, Poly cable glands													C
M20 Threads, Nickel Plated Brass cable glands													D
M20 Threads, no cable glands													A
Endpoint Wiring Method													
None													XX
Communication/Output													
Standard Output (Modbus RTU or BACnet MS/TP field selectable)													S
Standard Output plus Modbus TCP Ethernet													T
Standard Output plus BACnet/IP Ethernet													V
Standard Output plus EtherNet/IP													U
Units of Measure Totalizer/Flow Rate ²													
Gallons/gallons per minute													G
Liters/liters per minute													P
Testing & Tagging													
Factory Calibrated													F
Factory Calibrated/Stainless Steel Tag													S

¹ Submersible transducer cables use two conduit openings.

² Field selectable, additional options available.

TFX-5000 Energy Meters for Pipes 2 in. and Smaller

	DR	G											XX				
Model	TFX-5000 Ultrasonic Clamp-On Meter																
Certification	General Area US/Canada, CE																
Transducer Type ¹	1/2 inch ANSI Pipe CA 3/4 inch ANSI Pipe CB 1 inch ANSI Pipe CC 1-1/4 inch ANSI Pipe CD 1-1/2 inch ANSI Pipe CE 2 inch ANSI Pipe CF 1/2 inch Copper Tube CG 3/4 inch Copper Tube CH 1 inch Copper Tube CT 1-1/4 inch Copper Tube CJ 1-1/2 inch Copper Tube CK 2 inch Copper Tube CL Small pipe, universal, DTTSU (not available with conduit) UZ																
Transmitter Type	110/220V AC Remote Mounted R 24V DC/AC Remote Mounted B																
Display	Display and Keypad S No Display/Keypad W																
Remote Cable Length	15 feet (4.5 m) AC 30 feet (9 m) AF 50 feet (15 m) AK 75 feet (23 m) AR 100 feet (30 m) BW																
Conduit Type and Length (Conduit length is less than or equal to cable length)	None WW 5 feet (1.5 m) AA 15 feet (4.5 m) AC 30 feet (9 m) AF 50 feet (15 m) AK 75 feet (23 m) AR 100 feet (30 m) BW																
RTD Type	Surface, Commercial C None (user provided) X																
RTD Cable Length	15 feet AC 50 feet AK 100 feet BW None (user provided) WW																
Hardware	1/2 in. NPT Threads, Poly cable glands S 1/2 in. NPT Threads, Nickel Plated Brass cable glands T 1/2 in. NPT Threads, no cable glands N																
Endpoint Wiring Method	None XX																
Communication/Output	Standard Output (Modbus RTU or BACnet MS/TP field selectable) S Standard Output plus Modbus TCP Ethernet T Standard Output plus BACnet/IP Ethernet U Standard Output plus EtherNet/IP V Standard Output plus Auxiliary Dry Contact Output 9																
Units of Measure Totalizer/Flow Rate ²	Gallons/gallons per minute G Liters/liters per minute P																
Units of Measure Energy Totalizer/Rate	Kilowatt-hour/Watt (field selectable, additional options available) R																
Testing & Tagging	Factory Calibrated F Factory Calibrated/Stainless Steel Tag S																

¹ Stainless steel tube 1/2...2 in. options are available.

² Field selectable, additional options available.

TFX-5000 Energy Meters for Pipes 2.5 in. and Larger

	DR	G									XX			
Model	DR													
TFX-5000 Ultrasonic Clamp-On Meter														
Certification		G												
General Area US/Canada, CE														
Transducer Type														
Medium pipe, DTTR, 2.5 in. (65 mm) or larger														RZ
Medium pipe, submersible DTTN, 2.5 in. (65 mm) or larger ¹														WZ
2.5...6 inches (65...150 mm) Easy Rail (not available with conduit)														JZ
2.5...12 inches (65...300 mm) Easy Rail (not available with conduit)														KZ
Medium pipe, high temperature (not available with conduit)														HZ
Large pipe, DTTL, 8 in. (200 mm) or larger														LZ
Large pipe, submersible DTTL, 8 in. (200 mm) or larger ¹														YZ
Transmitter Type														
110/220V AC Remote Mounted														R
24V DC/AC Remote Mounted														B
Display														
Standard														S
No Display/Keypad														W
Remote Cable Length ²														
15 feet (4.5 m)														AC
30 feet (9 m)														AF
50 feet (15 m)														AK
75 feet (23 m)														AR
100 feet (30 m)														BW
150 feet (46 m)														BK
200 feet (61 m)														DW
250 feet (76 m)														DK
300 feet (90 m)														EW
Conduit Type and Length (Conduit length is less than or equal to cable length)														
None														WW
5 feet (1.5 m)														AA
15 feet (4.5 m)														AC
30 feet (9 m)														AF
50 feet (15 m)														AK
75 feet (23 m)														AR
100 feet (30 m)														BW
150 feet (46 m)														BK
200 feet (61 m)														DW
250 feet (76 m)														DK
300 feet (90 m)														EW
RTD Type														
Surface, Commercial														C
None (user provided)														X
RTD Length														
15 feet (4.5 m)														AC
50 feet (15 m)														AK
100 feet (30 m)														BW
None (user provided)														WW
Hardware														
1/2 in. NPT Threads, Poly cable glands														S
1/2 in. NPT Threads, Nickel Plated Brass cable glands														T
1/2 in. NPT Threads, no cable glands														N
M20 Threads, Poly cable glands														C
M20 Threads, Nickel Plated Brass cable glands														D
M20 Threads, no cable glands														A
Endpoint Wiring Method														
None														XX
Communication/Output														
Standard Output (Modbus RTU or BACnet MS/TP field selectable)														S
Standard Output plus Modbus TCP Ethernet														T
Standard Output plus BACnet/IP Ethernet														V
Standard Output plus EtherNet/IP														U
Standard Output plus Aux Output														9
Units of Measure Totalizer/Flow Rate ³														
Gallons/gallons per minute														G
Liters/liters per minute														P
Units of Measure Energy Totalizer/Rate														
Kilowatt-hour/Kilowatt (field selectable, additional options available)														R
Testing & Tagging														
Factory Calibrated														F
Factory Calibrated/Stainless Steel Tag														S

¹ Contact factory for DTTL cable lengths longer than 300 ft.

² Submersible transducer cables use two conduit openings.

³ Field selectable, additional options available.

NORTH AMERICAN PIPE SCHEDULES

Cast Iron Pipe, Standard Classes, 3... 10 inch

Size in.		Class in.							
		A	B	C	D	E	F	G	H
3	OD	3.80	3.96	3.96	3.96	—	—	—	—
	Wall	0.39	0.42	0.45	0.48				
	ID	3.02	3.12	3.06	3.00				
4	OD	4.80	5.00	5.00	5.00	—	—	—	—
	Wall	0.42	0.45	0.48	0.52				
	ID	3.96	4.10	4.04	3.96				
6	OD	6.90	7.10	7.10	7.10	7.22	7.22	7.38	7.38
	Wall	0.44	0.48	0.51	0.55	0.58	0.61	0.65	0.69
	ID	6.02	6.14	6.08	6.00	6.06	6.00	6.08	6.00
8	OD	9.05	9.05	9.30	9.30	9.42	9.42	9.60	9.60
	Wall	0.46	0.51	0.56	0.60	0.66	0.66	0.75	0.80
	ID	8.13	8.03	8.18	8.10	8.10	8.10	8.10	8.00
10	OD	11.10	11.10	11.40	11.40	11.60	11.60	11.84	11.84
	Wall	0.50	0.57	0.62	0.68	0.74	0.80	0.86	0.92
	ID	10.10	9.96	10.16	10.04	10.12	10.00	10.12	10.00

Table 8: Cast iron pipe, standard classes, 3... 10 inch

Steel, Stainless Steel, PVC Pipe, Standard Classes

NPS in.	OD in.	SCH 60		X STG.		SCH 80		SCH 100		SCH 120/140		SCH 180					
		ID in.	Wall in.	ID in.	Wall in.	ID in.	Wall in.	ID in.	Wall in.	ID in.	Wall in.	ID in.	Wall in.				
1	1.315	—	—	0.957	0.179	0.957	0.179	—	—	—	—	0.815	0.250				
1.25	1.660			1.278	0.191	1.278	0.191					1.160	0.250				
1.5	1.900			1.500	0.200	1.500	0.200					1.338	0.281				
2	2.375			1.939	0.218	1.939	0.218					1.687	0.344				
2.5	2.875			2.323	0.276	2.323	0.276					2.125	0.375				
3	3.500			2.900	0.300	2.900	0.300					2.624	0.438				
3.5	4.000	—	—	3.364	0.318	3.364	0.318	—	—	—	—	—	—				
4	4.500			3.826	0.337	3.826	0.337							3.624	0.438	3.438	0.531
5	5.563			4.813	0.375	4.813	0.375							4.563	0.500	4.313	0.625
6	6.625			5.761	0.432	5.761	0.432							5.501	0.562	5.187	0.719
8	8.625	7.813	0.406	7.625	0.500	7.625	0.500	7.437	0.594	7.178	0.719	6.183	1.221				
10	10.75	9.750	0.500	9.75	0.500	9.562	0.594	9.312	0.719	9.062	0.844	8.500	1.125				

Table 9: Steel, stainless steel, PVC pipe, standard classes

Steel, Stainless Steel, PVC Pipe, Standard Classes (continued)

NPS in.	OD in.	SCH 5		SCH 10 (Lt Wall)		SCH 20		SCH 30		STD		SCH 40		
		ID in.	Wall in.	ID in.	Wall in.	ID in.	Wall in.	ID in.	Wall in.	ID in.	Wall in.	ID in.	Wall in.	
1	1.315	1.185	0.065	1.097	0.109	—	—	—	—	1.049	—	1.049	0.133	
1.25	1.660	1.53	0.065	1.442	0.109					1.380		1.380	0.140	
1.5	1.900	1.77	0.065	1.682	0.109					1.610		1.610	0.145	
2	2.375	2.245	0.065	2.157	0.109					2.067		2.067	0.154	
2.5	2.875	2.709	0.083	2.635	0.120					2.469		2.469	0.203	
3	3.500	3.334	0.083	3.260	0.120					3.068		3.068	0.216	
3.5	4.000	3.834	0.083	3.760	0.120					3.548		—	3.548	0.226
4	4.500	4.334	0.083	4.260	0.120					4.026		0.237	4.026	0.237
5	5.563	5.345	0.109	5.295	0.134					5.047		0.258	5.047	0.258
6	6.625	6.407	0.109	6.357	0.134					6.065		0.280	6.065	0.280
8	8.625	8.407	0.109	8.329	0.148	8.125	0.250	8.071	0.277	7.981	0.322	7.981	0.322	
10	10.75	10.482	0.134	10.42	0.165	10.25	0.250	10.13	0.310	10.02	0.365	10.02	0.365	

Table 10: Steel, stainless steel, PVC pipe, standard classes (continued)

Copper Tubing, Copper and Brass Pipe, Aluminum

Nominal Diameter in.		Copper Tubing in.			Copper & Brass Pipe in.	Alum. in.	Nominal Diameter in.	Copper Tubing in.			Copper & Brass Pipe in.	Alum. in.		
		Type						Type						
		K	L	M				K	L	M				
0.5	OD	0.625	0.625	0.625	0.840	—	3-1/2	OD	3.625	3.625	3.625	4.000	—	
	Wall	0.049	0.040	0.028	0.108			Wall	0.120	0.100	0.083	0.250		
	ID	0.527	0.545	0.569	0.625			ID	3.385	3.425	3.459	3.500		
0.6250	OD	0.750	0.750	0.750	—	—	4	OD	4.125	4.125	4.125	4.500	4.000	
	Wall	0.049	0.042	0.030				Wall	0.134	0.110	0.095	0.095	0.250	
	ID	0.652	0.666	0.690				ID	3.857	3.905	3.935	3.935	4.000	
0.75	OD	0.875	0.875	0.875	1.050	—	4-1/2	OD	—	—	—	—	5.000	
	Wall	0.065	0.045	0.032	0.114			0.250						
	ID	0.745	0.785	0.811	0.822			4.500						
1	OD	1.125	1.125	1.125	1.315	—	5	OD	5.125	5.125	5.125	5.563	5.000	
	Wall	0.065	0.050	0.035	0.127			Wall	0.160	0.125	0.109	0.250	0.063	
	ID	0.995	1.025	1.055	1.062			ID	4.805	4.875	4.907	5.063	4.874	
1.25	OD	1.375	1.375	1.375	1.660	—	6	OD	6.125	6.125	6.125	6.625	6.000	
	Wall	0.065	0.055	0.042	0.146			Wall	0.192	0.140	0.122	0.250	0.063	
	ID	1.245	1.265	1.291	1.368			ID	5.741	5.845	5.881	6.125	5.874	
1.5.	OD	1.625	1.625	1.625	1.900	—	7	OD	—	—	—	—	7.625	7.000
	Wall	0.072	0.060	0.049	0.150			0.282					0.078	
	ID	1.481	1.505	1.527	1.600			7.062					6.844	
2	OD	2.125	2.125	2.125	2.375	—	8	OD	8.125	8.125	8.125	8.625	8.000	
	Wall	0.083	0.070	0.058	0.157			Wall	0.271	0.200	0.170	0.313	0.094	
	ID	1.959	1.985	2.009	2.062			ID	7.583	7.725	7.785	8.000	7.812	
2.5	OD	2.625	2.625	2.625	2.875	2.500	10	OD	10.125	10.125	10.125	10.000	—	
	Wall	0.095	0.080	0.065	0.188	0.050		Wall	0.338	0.250	0.212	0.094	—	
	ID	2.435	2.465	2.495	2.500	2.400		ID	9.449	9.625	9.701	9.812	—	
3	OD	3.125	3.125	3.125	3.500	3.000	—	—	—	—	—	—	—	
	Wall	0.109	0.090	0.072	0.219	0.050		—	—	—	—	—	—	
	ID	2.907	2.945	2.981	3.062	2.900		—	—	—	—	—	—	

Table 11: Copper tubing, copper and brass pipe, aluminum

Control. Manage. Optimize.

Dynasonics, AquaCUE and SoloCUE are registered trademarks of Badger Meter, Inc. Other trademarks appearing in this document are the property of their respective entities. Due to continuous research, product improvements and enhancements, Badger Meter reserves the right to change product or system specifications without notice, except to the extent an outstanding contractual obligation exists. © 2022 Badger Meter, Inc. All rights reserved.

www.badgermeter.com