

Wall Mount Oxygen Analyzer



Online Trace Oxygen Analyzer, IP66 / NEMA 4X Wall Mount Enclosure

Trace, Percent, or Purity Configuration

Precision Fuel Cell Oxygen Sensor Technology

Measure Oxygen from 0.01 ppm to 100%

Large Easy-to-Read Display

Intuitive User Friendly Menu Interface

Compact Indoor or Outdoor Enclosure

Cost Effective and Low Maintenance

Integral USB Data Logging

Specifications:

Accuracy:	+/- 1% Full Scale Range*
Display:	LCD with Backlight
Dimensions:	9.5 x 6.5 x 3.8 Inches
Enclosure:	Wall Mount IP66 / NEMA4X
Classification:	General Purpose
Temperature:	0 - 50°C
Alarms:	2 Adjustable w/ delay mode
Power:	100 - 240 VAC or 10 - 28 VDC
Data Logging:	Removable USB Stick
Signal Output (analog):	4 - 20mA
Communication	Bi-Directional MODBUS RS485 ASCII
Range ID:	1 - 5 VDC (Optional 4 -20mA)
Calibration:	Periodically
Pressure:	0.1 - 50 PSIG
Temperature Compensation:	Integral
Flow Sensitivity:	0.5 - 5 SCFH
Warranty:	12 Months Sensor 12 Months Electronics

*Accuracy at constant conditions

Applications:

- Nitrogen and O2 PSA Generators
- Laboratories & Universities
- Beverage Grade CO2 Monitoring
- Welding & 3D Printers
- Air Separation Plants
& Many Others

"Inquiry for Application Expertise"

The OMD-525X offers the unique ability to log data in real time via a removable USB drive. Data is logged in an Excel compatible .csv file by date with an interval between 1 and 120 minutes.

Logging at intervals of 1 minute you can store up to approximately 50 years worth of data before filling up an 8GB USB flash drive.

The analyzer can be configured for trace (parts-per-million), percent, or purity applications by the user by selecting the desired ranges in the built-in menu and using the appropriate sensor.

Oxygen Analyzer:

The model OMD-525X oxygen analyzer combines a rugged in-line design with SSO2's precision oxygen sensors. The result is a highly reliable and cost effective compact design with an easy-to-use user interface.

The analyzer can be configured for either 10-28 VDC or 100-240 VAC power to fit a variety of applications. It can also be configured for trace, (parts-per-million) percent, or purity analysis using the on-board menu and correct sensor.

The auto-range feature allows the user to read O2 throughout all relevant ranges on the local display in large font.

The output can be range selected through the on-board menu allowing easy interface with a PLC, DCS or other control system.

Gas connections are made with compression tube fittings (1/8", 1/4" or 6mm).

Optional Alarms:

2-non latching fully configurable Form C relay contact alarms.

Oxygen Sensor Technology:

The oxygen sensor used in the OMD-525X is based on the galvanic electrochemical fuel cell principal. All oxygen sensors are manufactured in house by Southland Sensing Ltd. under a strict quality program.

The standard cells are unaffected by other background gases such as H2, He or Hydrocarbons. The acidic cells work well when acid gases such as CO2 or Natural Gas are present.

The sensors are self-contained and minimal maintenance is required - no need to clean electrodes or add electrolyte.

The SSO2 precision oxygen sensors offer excellent performance, accuracy and stability while maximizing the expected life.

Oxygen Sensors:

- TO2-1x PPM Oxygen Sensor: Trace Analysis, Standard
- TO2-2x PPM Oxygen Sensor: Trace Analysis, Acidic
- PO2-160 Percent Oxygen Sensor: Percent Analysis, Standard
- PO2-24 Percent Oxygen Sensor: Percent Analysis, Acidic
- PO2-1120 Purity Oxygen Sensor: Percent Analysis, Standard
- TO2-19 Hybrid Oxygen Sensor: Percent or Trace Analysis

Oxygen sensors should be periodically calibrated. Factory recommendation is every 2 - 3 months or as the application dictates. Sensors offer excellent linearity with an air calibration, or calibrate to a certified span gas to maximize accuracy.

Order Information:

Record Part Number with selected options in Blank Indicated Area of Form

Model Number:

OMD-525X Oxygen Analyzer

Selected Range & Sensor:

- 1 Trace Analysis Standard (TO2-1x): 0 - 10ppm, 0 - 100ppm, 0 - 1000ppm, 0 - 1%, 0 - 25%
- 2 Trace Analysis Acidic (TO2-2x): 0 - 10ppm, 0 - 100ppm, 0 - 1000ppm, 0 - 1%, 0 - 25%
- 5 Percent Analysis Standard (PO2-160): 0 - 1%, 0 - 5%, 0 - 10%, 0 - 25%, 0 - 100%
- 6 Percent Analysis Acidic (PO2-24): 0 - 1%, 0 - 5%, 0 - 10%, 0 - 25%, 0 - 100%
- 7 Purity Analysis Standard (PO2-1120): 0 - 1%, 0 - 5%, 0 - 10%, 0 - 25%, 0 - 100%

Power Option:

- A 100 - 240 VAC Analyzer, 4-20 mA Analog Output, Integral Alarms, MODBUS RS485 ASCII
- D 10 - 28 VDC Analyzer, 4-20 mA Analog Output, Integral Alarms, MODBUS RS485 ASCII

Gas Connections:

- 8 1/8" Compression Tube Fittings
- 4 1/4" Compression Tube Fittings
- 6 6 mm Compression Tube Fittings

OMD-525X - _____ - _____ - _____ Use This Part Number When Ordering

1.4.1 General Safety & Installation (VAC)

This section is for AC powered analyzers, if your analyzer is DC powered proceed to the next page.

This section summarizes the precautions applicable to the OMD-525X Oxygen Analyzer. Additional precautions specific to this analyzer are contained in the following sections of the manual. To operate the analyzer safely and to obtain the best performance, follow the basic guidelines outlines in this owner's manual.



CAUTION: This symbol is used throughout the owner's manual to caution and alert the user that this device is operated on AC Voltage (VAC)



CAUTION: This symbol is used throughout the owner's manual to caution and alert the user to recommended safety and / or operating guidelines.



WARNING: This symbol is used throughout the owner's manual to warn and alert the user of the presence of electrostatic discharge.

READ INSTRUCTIONS: Before operating the oxygen analyzer, read the instructions.

RETAIN INSTRUCTIONS: The safety precautions and operating instructions found in the owner's manual should be retained for future reference.

FOLLOW INSTRUCTIONS: Observe all precautions and operating instructions. Failure to do so may result in personal injury or damage to the transmitter.

OXYGEN ANALYZER LABEL:

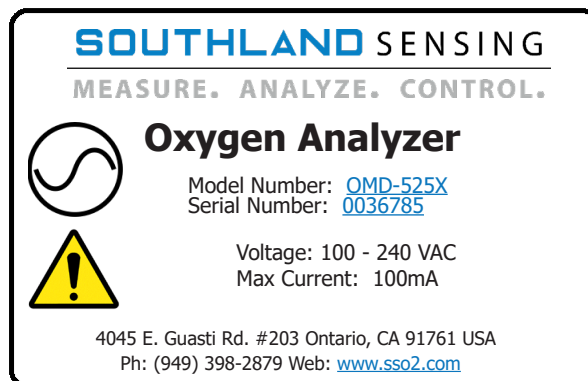

1.4.2 General Safety & Installation (VDC)

This section is for DC powered analyzers, if your analyzer is AC powered see the previous page.

This section summarizes the precautions applicable to the OMD-525X Oxygen Analyzer. Additional precautions specific to this analyzer are contained in the following sections of the manual. To operate the analyzer safely and to obtain the best performance, follow the basic guidelines outlines in this owner's manual.

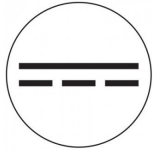

CAUTION: This symbol is used throughout the owner's manual to caution and alert the user that this device is operated on DC Voltage (VDC)



CAUTION: This symbol is used throughout the owner's manual to caution and alert the user to recommended safety and / or operating guidelines.



WARNING: This symbol is used throughout the owner's manual to warn and alert the user of the presence of electrostatic discharge.

READ INSTRUCTIONS: Before operating the oxygen analyzer, read the instructions.

RETAIN INSTRUCTIONS: The safety precautions and operating instructions found in the owner's manual should be retained for future reference.

FOLLOW INSTRUCTIONS: Observe all precautions and operating instructions. Failure to do so may result in personal injury or damage to the transmitter.

OXYGEN ANALYZER LABEL:

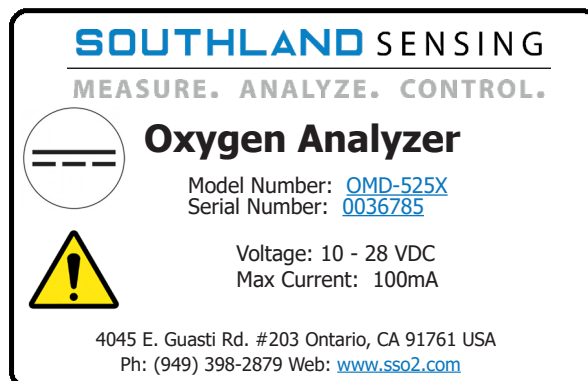

1.5 Location Installation Considerations

The Southland Sensing OMD-525X Oxygen Analyzer is designed to be wall mounted in a general purpose area and uses a NEMA4X / IP66 Enclosure. When installed outdoors in cold areas an optional heater is recommended as well. Consider also giving the analyzer a sun shield if it is going to be mounted in the direct sunlight.

Reference your local electrical authority for the proper installation.

The analyzer is EMI / RFI protected, however it is good practice not to mount it too close to sources of electrical interference such as large transformers, motor start contactors, relays, large pumps, etc. Also avoid subjecting the analyzer to significant vibration.

Mount the unit at a suitable eye level to easily read the local display. Gas connections are located on the top right side of the analyzer, ensure there is adequate room to hook up your gas lines.

1.6 Safety Considerations

The oxygen analyzer is designed for installation into a general purpose area. Please follow your local electrical code.

2.1 Receiving Your New Oxygen Analyzer

As soon as you receive your new oxygen analyzer carefully unpack the unit and accessories and inspect the interior and exterior of the analyzer for damage, and also verify the oxygen sensor is present.

CAUTION: Do not open the oxygen sensor packaging at this time. It is packed in a nitrogen purged bag and will be damaged if left exposed to ambient air for a prolonged period of time. It is recommended that you read through the instruction manual installation and operation sections before attempting to open the bag the oxygen sensor is packed in. For questions, please contact the factory.

If damage to any portion of the new analyzer is present, stop and report damage to the shipping company as well as the factory.

The analyzer is shipped with all materials needed to install and prepare the system for operation. In some instances, added sample system components are necessary to condition the gas sample before entering the sensor housing. Southland Sensing offers free application consultation and we encourage you to take advantage of our engineers and their expertise.

It is also important to be mindful of EMI / RFI noise interference. Protection from EMI / RFI noise is important for accurate readings.

2.2 Mounting the Oxygen Analyzer

The OMD-525X is designed for general purpose installations. If mounting in extreme temperature consider a secondary heated enclosure.

Refer to Part 3: Operation section of this instruction manual for more information on how to operate the controls of this oxygen analyzer.

Refer to Part 4: Maintenance section for an overview on how to calibrate the device using a certified span gas or ambient air.

A precision electrochemical oxygen sensor is included as a separate item and must be installed prior to instrument use.

CAUTION: Do not open the nitrogen filled oxygen sensor bag until you have thoroughly read the instruction manual and have made all gas and electrical connections. Please refer to section 2.5 to reference installing the oxygen sensor into the sensor housing as well as section 4.1 and 4.2 on SPAN Calibration.

When installing the analyzer, it is important to make sure the unit is wall mounted standing upright. This ensures the sensor is always facing down (sensing surface down, circuit board up) to allow any air bubbles to not interfere with the sensing membrane.

Oxygen Sensor Front and Rear View

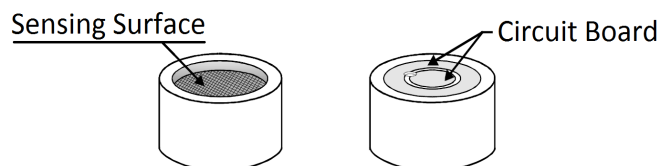

The sensor housing has 4 wires and should arrive wired to the circuit board, into the green terminal block as follows:

Sensor (+) red wire = Sensor (+) Pin
Sensor (-) black wire = Sensor (-) Pin
Temp Comp white wire = Sensor TH Pin
Temp Comp green wire = Sensor TH Pin

2.2 (Cont) Mounting the Oxygen Analyzer

OMD-525X Mounting Dimensions.

Sizes are in mm and inches

Front View

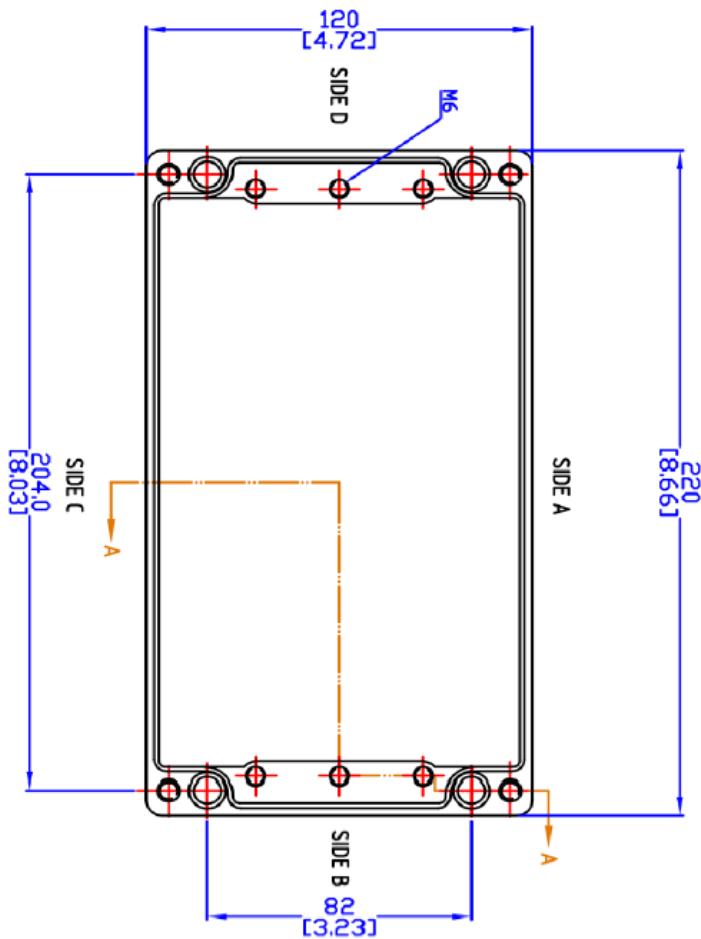

Top View

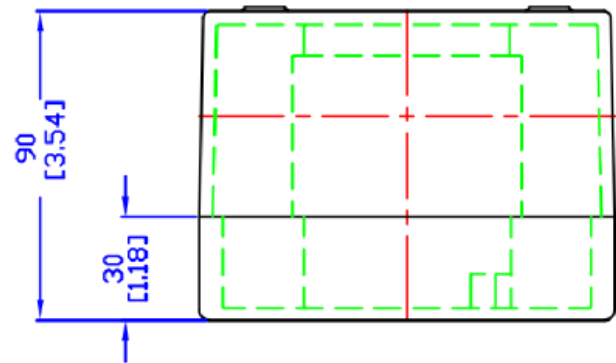

2.3.1 Electrical Connections (VAC)

This section is for AC powered analyzers, if your analyzer is DC powered proceed to the next page.



Incoming power/signal output connections are made to the green terminal block located on the Back of the unit.

Do not supply voltage more than specified in this manual and noted on the analyzer label inside of the unit.

Shielded cable is recommended when connecting power and signal output.

- Relay 1 NC
- Relay 1 Common
- Relay 1 NO
- Relay 2 NC
- Relay 2 Common
- Relay 2 NO

- 4-20 mA Negative
- 4-20 mA Positive
- 0-1 VDC Negative
- 0-1 VDC Positive



Voltage: 100 - 240 VAC
Max Current: 100 mA



Avoid electrostatic discharge



Follow your local electrical authority for proper procedure.

It is also recommended to make sure you have the proper seals for your conduit to meet your required installation consideration. Check with your local electrical authority.

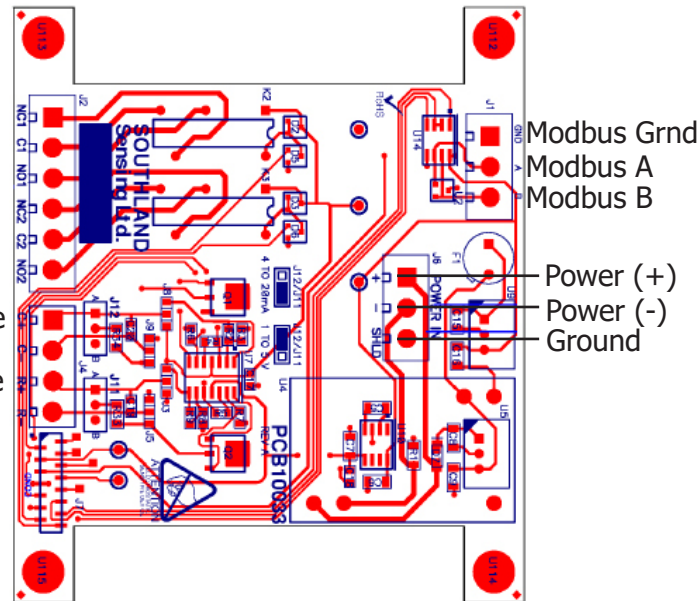

** Note: This device is designed to be integrated with a PLC or DCS system. The power input should be 100 - 240 VAC. The electronics self generate a 4 - 20mA analog output.

DO NOT hook up power to either the ANALOG OUTPUT or RANGE ID as the circuit will be damaged.

2.3.2 Electrical Connections (VDC)

This section is for DC powered analyzers, if your analyzer is AC powered go to the previous page.



Incoming power/signal output connections are made to the green terminal block located on the Back of the unit.

Do not supply voltage more than specified in this manual and noted on the analyzer label inside of the unit.

Shielded cable is recommended when connecting power and signal output.

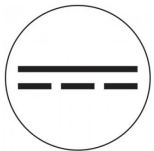

Voltage: 10 - 28 VDC
Max Current: 100 mA

- Relay 1 NC
- Relay 1 Common
- Relay 1 NO
- Relay 2 NC
- Relay 2 Common
- Relay 2 NO

- 4-20 mA Negative
- 4-20 mA Positive
- 0-1 VDC Negative
- 0-1 VDC Positive

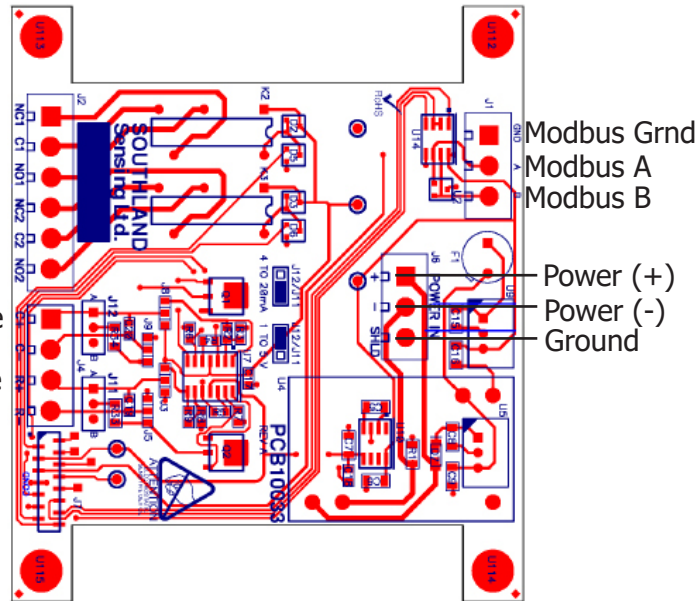

Avoid electrostatic discharge



Follow your local electrical authority for proper procedure.

It is also recommended to make sure you have the proper seals for your conduit to meet your required installation consideration. Check with your local electrical authority.

** Note: This device is designed to be integrated with a PLC or DCS system. The power input should be 10 - 28 VDC. The electronics self generate a 4 - 20mA analog output.

DO NOT hook up power to either the ANALOG OUTPUT or RANGE ID as the circuit will be damaged.

2.4 Gas Connections

Gas Connections are made via compression tube fittings directly on the analyzer, inlet / outlet can flow in either direction. Various tube fittings sizes are available, check with the build sheet for specific gas connection sizes.

2.5 Installing the Oxygen Sensor

CAUTION: Prior to installing the oxygen sensor read section 4.1 on performing a span calibration.

The OMD-525X can accept either a TO2-1x or TO2-2x (for CO₂ applications, i.e. natural gas) oxygen sensor for trace oxygen analysis. For percent measurement, the OMD-525X can accept either a PO2-160 or PO2-24 (for CO₂ applications) oxygen sensor. For high purity percentage levels of oxygen the PO2-1120 sensor should be used. For a hybrid application where the user is monitoring oxygen from 50 ppm up to 21.0% with regular exposure to ambient air, consider the TO2-19 Hybrid Oxygen Sensor. For help selecting a sensor, contact your local sales rep or the factory.

Prior to installing the sensor, it is important to make sure that the analyzer gas lines are hooked up and the unit is ready to purge with a zero or process gas. Connect the zero gas line and set your flow between 0.50 - 5.0 SCFH.

To Install the Sensor:

- Remove the four screws and open the front of the analyzer.
- Remove the cell holder cap by unscrewing the stainless steel collar.
- Lift up on the top of the sensor housing and set it to the side.
- Inspect O-ring for cracking, replace if necessary. Always lube your O-rings!
- Remove the sensor from its box. With scissors, open nitrogen purged packaging and remove the sensor.
- Visually inspect sensor for damage, if damaged notify the factory immediately.
- Remove the shorting tab across the back of the sensor circuit board (red tape).
- Place the sensor inside the housing with the metal mesh screen facing down and the circuit board contacts facing up.
- Return upper portion of the sensor housing to the stainless steel bottom. Tighten collar. Hand tight is acceptable to create an airtight seal.
- Immediately start purge of zero gas.
- If the analyzer has not been calibrated, refer to section 4.1 for more information.

**** Sensor should not be exposed to ambient air for more than 2 minutes. Extended periods of exposure can damage the low end sensitivity and response time.**

Oxygen Sensor Front and Rear View

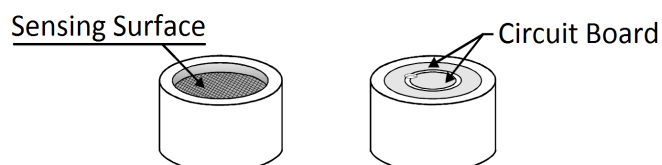

3.1 Understanding the Controls and their Operation

The OMD-525X Oxygen Analyzer is a feature packed unit with an easy-to-use menu interface. The key attributes within the menu are the ability to select a measurement range manually or using the auto-range mode, to calibrate the unit with a known gas, also referred to as a SPAN Calibration or SPAN CAL, and to perform a zero calibration (if necessary, most applications it is not required).

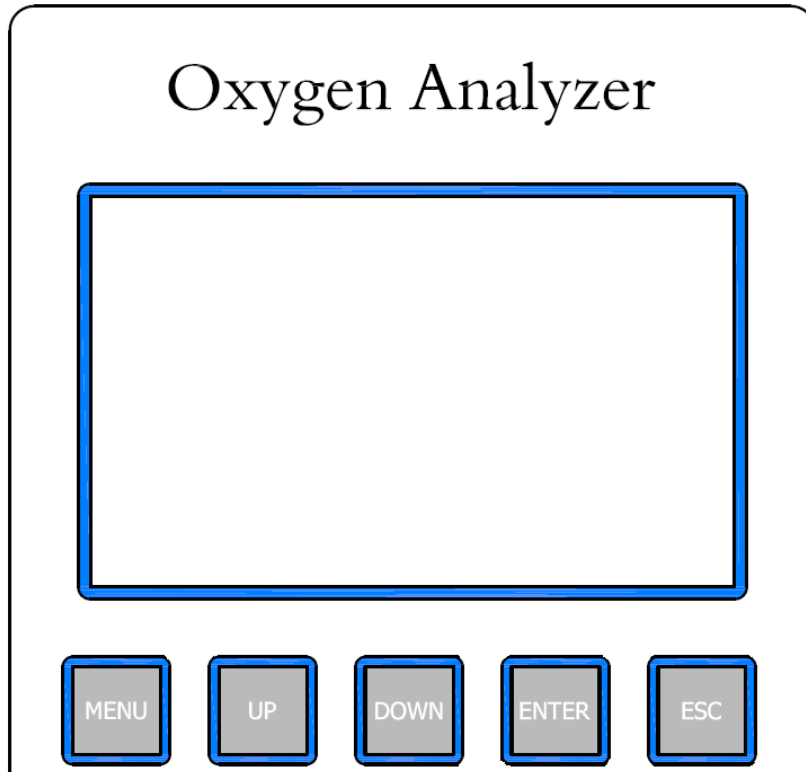

All features are programmable / selectable through the MENU button. The UP / DOWN buttons will allow you to select your set points and the ENTER button saves the data. If you want to cancel your selection, or return to the previous screen the escape key ESC will allow you to do this. Once the unit starts up, the following home screen will appear:

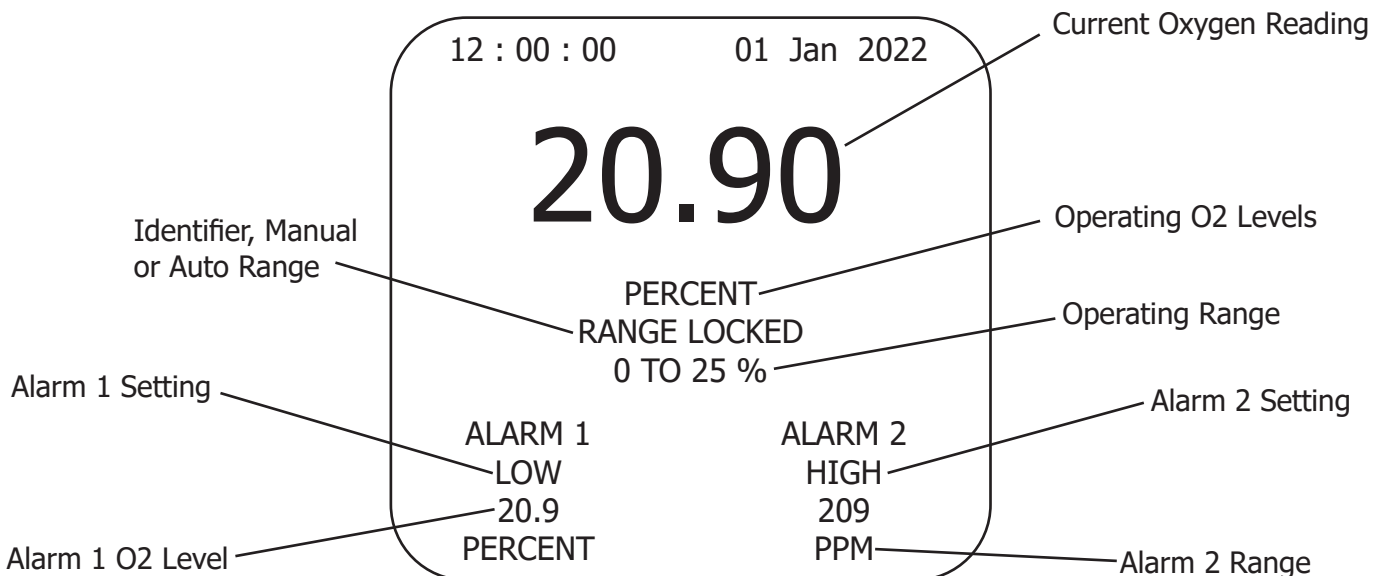

3.2 Setting the Date and Time

The OMD-525X oxygen analyzer is equipped with an onboard time and date stamp on the main screen. This function is important to keep accurate if you are going to be taking advantage of the integral USB data logging.

The time is set to Pacific Standard Time, if you are located outside of that time zone it is suggested that you adjust the time to your local standard time. The date may also need to be adjusted.

To set the time or date, start by pressing the MENU key to open up the onboard menu.

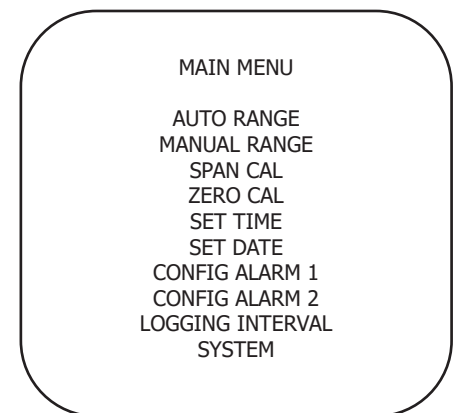

To set the time, select the SET TIME function. From here it will allow you to adjust the hours, minutes, and seconds using the UP and DOWN keys. The number being changed will be highlighted, press ENTER to proceed to the next one.

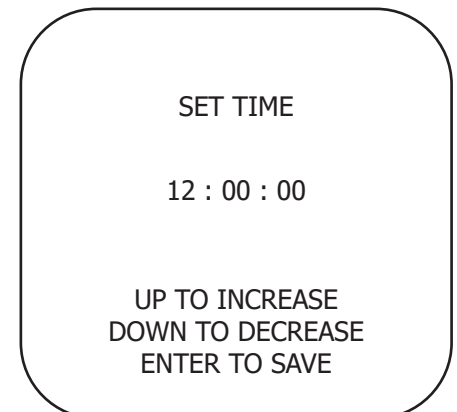

To set the date, select the SET DATE function. This will allow you to adjust the day, month, and year using the UP and DOWN keys, the process being nearly identical to setting the time.

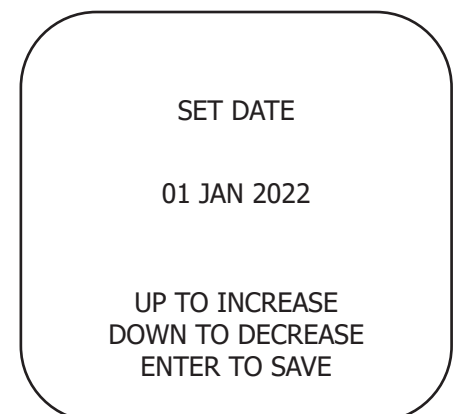

3.3 Measurement Range Overview

The OMD-525X oxygen analyzer allows the user to field select 5 available ranges - custom ranges can be programmed in the built-in menu, see Section 3.7. These ranges can be selected in manual mode, meaning they are locked into that range by the user, or they can be set to auto-range so the analyzer will adjust to give you the best full scale resolution.

When using the Manual-Range mode the Manual Range locks the 4 - 20mA output to a single range, and the display will continue to operate in auto-range mode giving the user the full spectrum of analysis ranges. Other manufactures lock the display as well - the problem is if you over-range and the display is locked you have no idea what your oxygen value is. The OMD-525X solves this issue with a display that auto-ranges and the ability to manually lock the analog outputs.

To select Auto-Range or Manual-Range Mode, from the HOME screen, press the MENU key and the display will indicate:

Using the UP / DOWN keys to change which option is highlighted will allow the user to select AUTO-RANGE, which will allow the unit to cycle through all five ranges, or MANUAL RANGE which will allow the user to select a specific range.

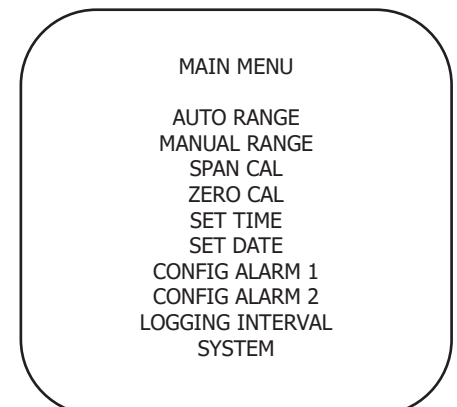

Decide which option will work best for your application. Highlight the selection and press the ENTER key. If you have selected the AUTO RANGE option, it will blink for a second indicating this was selected. If you selected the MANUAL RANGE option, the following screen will be brought up:

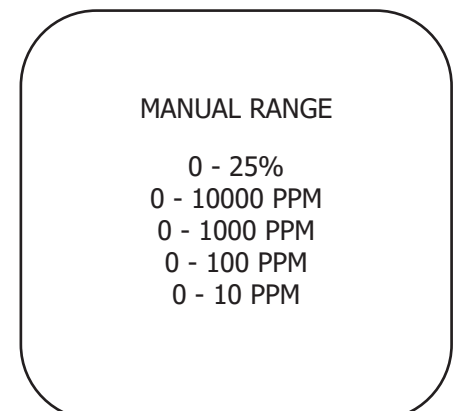

****Note: Analyzers can be configured for Trace, Percent and Purity Analysis so your ranges might be different.**

Trace: 0 - 10ppm, 0 - 100ppm, 0 - 1000ppm, 0 - 10000ppm, 0 - 25%

Percent: 0 - 1%, 0 - 5%, 0 - 10%, 0 - 25%, 0 - 100%

If a custom range has been set, it will appear below the 0 - 10 ppm range.

Use the UP / DOWN keys to highlight the range to be selected and press the ENTER key. The selected range will blink for a second indicating the range has been selected.

Press the ESC key to move back to the previous screen.

3.4 Analog Output

**** Caution: Integral 4 - 20mA converters are internally powered and do not require external power. DO NOT supply any voltage across these terminals as the 4 - 20mA output will be damaged. It is also important to assure proper grounding of the external recording device such as a PLC, DCS prior to connecting the 4 - 20mA.**

The OMD-525X is equipped with a 4 - 20mA analog output. When physically connecting the analog output, refer to the circuit board pinout in section 2.3

To verify the signal output of the 4 - 20mA circuit is working properly, connect an ammeter across the (+) and (-) pins. With no oxygen sensor connected, it should read approximately 4 mA. If a sensor is installed you can verify the signal matches with the following formula:

$$\text{Signal Output (mA)} = [(\text{Reading} / \text{Full Scale Range}) \times 16] + 4$$

For example, if we are reading 500ppm on the 1000 ppm range:

$$\text{Signal Output (mA)} = [(500/1000) \times 16] + 4$$

$$\text{Signal Output (mA)} = 12\text{mA}$$

The OMD-525X has a menu feature that allows the analog output to be adjusted to compensate for any internal resistance in the connection. To adjust the 4 - 20mA enter the MENU and select SYSTEM, then select OUTPUT CAL. Push the UP or DOWN buttons to adjust the 4mA zero setting, continue to push UP and DOWN as needed. Once complete, you will be prompted to adjust the upper 20mA output in the same fashion with the UP and DOWN buttons.

3.5 Advanced Integral Alarms

The OMD-525X Oxygen Analyzer is equipped with 2 advanced relay contact alarms. These alarms can be configured as normally open or normally closed, have a delay mode built-in, and can be enabled or disabled when necessary.

The alarms are rated at 5A @ 230VAC. If you are connecting to solenoid valves or a pump whose current can fluctuate greatly, it is advisable to use a slave relay to ensure no damage occurs to the electronics.

The procedure for setting Alarm 1 and Alarm 2 is identical. To begin, highlight the alarm configuration you want to adjust using the UP / DOWN keys in the analyzer MENU and press ENTER.

To adjust the value setpoint of ALARM 1 simply highlight ALARM 1 and press ENTER. Select the ADJUST ALARM option, where you will be able to adjust the levels using the UP / DOWN buttons. To set a PPM level alarm simply hold the DOWN button until you get below 1%. To set the alarm press ENTER.

The alarm function allows the user to set the alarm to trigger the relay contacts as a HIGH alarm or a LOW alarm. Simply open the ALARM 1 menu and UP or DOWN to meet your requirements.

The alarm has a built in DELAY TIME. This is ideal to use when you are working on your process and do not want to have the alarm relay contacts trip. You will set this in a similar fashion to setting the alarm. The DELAY TIME is in minutes, so adjust the value accordingly.

The alarm can also be enabled / disabled should it be hooked up but not required. Highlight ALARM ON/OFF using the UP / Down keys to and press the ENTER key.

The alarms can function as normally open or normally closed. This selection will be chosen when hooking up the rear wiring, it is not completed through the software. See the wiring diagram in section 2.4 for more information.

If you any questions about the ALARM functions should arise, please contact the factory for assistance or technical questions.

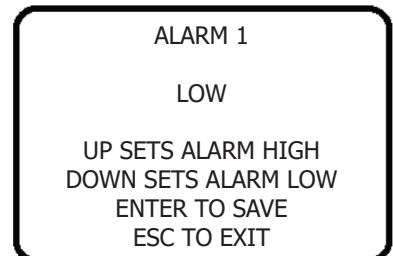
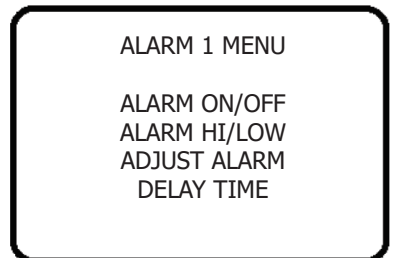
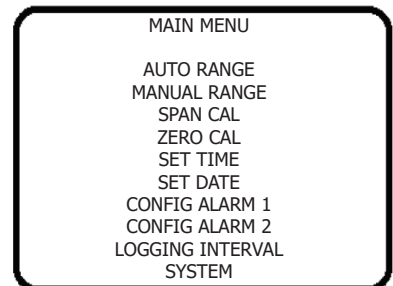

Alarm adjustment screen

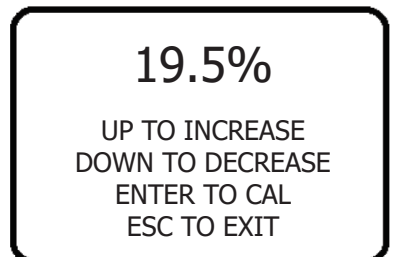

Alarm delay screen

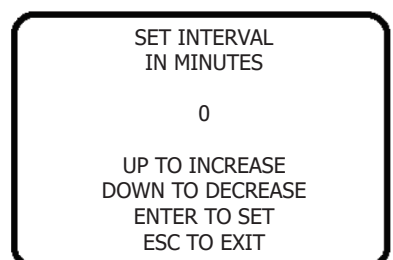

3.6 Range ID

**** Caution: RANGE ID converters are internally powered and do not require external power. DO NOT supply any voltage across these terminals as the output will be damaged. It is also important to assure proper grounding of the external recording device.**

Refer to section 2.3 for electrical wiring diagram.

When connecting the RANGE ID, connect to the (+) positive and (-) negative sides of the RANGE output on the rear of the analyzer. To verify the signal output of the RANGE ID is working properly, connect a voltmeter across the terminals to verify. You can change the range manually in MANUAL RANGE mode to verify:

	PPM Config.	Percent Config.	Output
Range 1	0 - 10 ppm	0 - 1%	1 VDC
Range 2	0 - 100 ppm	0 - 5%	2 VDC
Range 3	0 - 1000 ppm	0 - 10%	3 VDC
Range 4	0 - 10000 ppm	0 - 25%	4 VDC
Range 5	0 - 25%	0 - 100%	5 VDC

3.7 Selecting Sensor Type

The OMD-525X Oxygen Analyzer is designed to be field-configurable for use with either trace, percent, or hybrid sensors. This allows you to use one analyzer for a variety of applications by simply switching out which sensor is in the housing and changing a setting in the menu, which provides a lot of flexibility in one analyzer.

To change the analysis ranges, perform the following steps:

Press the MENU button to go into the onboard menu. Use the UP/DOWN buttons to scroll down to SYSTEM and press the ENTER button.

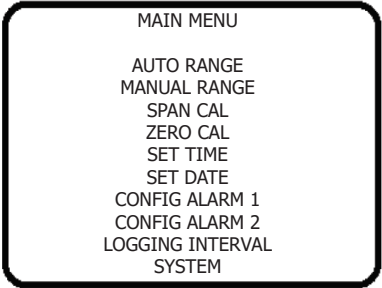

Scroll down to highlight SENSOR TYPE and press ENTER.

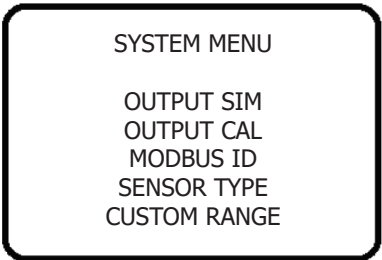

Select either PPM or PERCENT and press ENTER to set the range. PPM configuration will correspond to use with a TO2-1x, TO2-2x, or TO2-19 sensor. Percent configuration will correspond to use with the PO2-160, PO2-24, or PO2-1120 sensor.

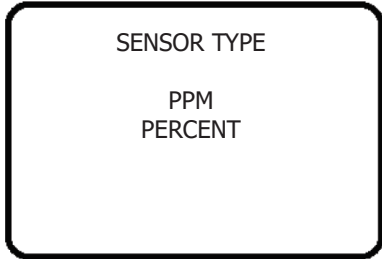

Note: Ensure that you are putting the correct sensor into the housing for the ranges you are measuring. For example, if you have a TO2-1x sensor installed and set the analyzer to percent analysis it will give you an incorrect O2 reading. This feature works by adjusting which output the analyzer is looking for, as trace and percent sensors have very different outputs at different O2 levels.

Sensor Model Number	Sensor Type
TO2-1x	PPM
TO2-2x	PPM
TO2-19	PPM
PO2-160	Percent
PO2-24	Percent
PO2-1120	Percent

3.8 Setting a Custom Range

The OMD-525X Oxygen Analyzer can have a custom range programmed into it in case you need a specific non-standard range. Once you have set your custom range, you can select it in the Manual Range menu to lock the 4-20 mA output to that range.

To set a custom range, perform the following steps:

Press the MENU button to go into the onboard menu. Use the UP/DOWN buttons to scroll down to SYSTEM and press the ENTER button.

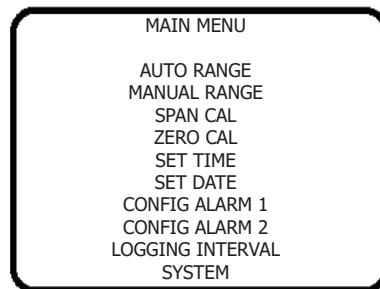

Scroll down to highlight CUSTOM RANGE and press ENTER.

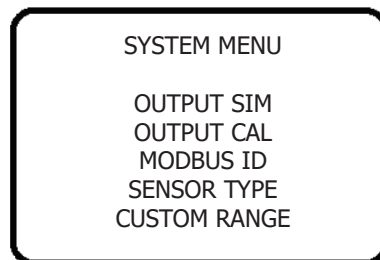

The value shown will be the upper value of the range, in this case the custom range is going to be 0-995 PPM. Use the UP button to increase the value, and the DOWN button to decrease it. Press ENTER to lock in the value, or ESC to return to the menu.

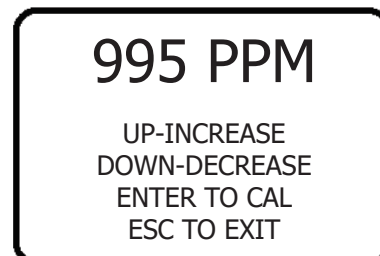

3.9 USB Data Logging

Note: We have tested 100s of USB flash drives and 99% of them work just fine. Prior to data logging important data, make sure to test your USB thumb drive and verify it is logging. The USB Icon should appear or disappear as the USB stick is installed or removed. If for some reason the electronics don't recognize the USB stick, consider restarting the analyzer to see if the USB Icon appears.

To install a USB flash drive, simply plug it into the left side of the display panel. This port will allow the electronics to talk to your USB flash drive and save the stored data in an .csv file (excel compatible).

The data is stored in files by date and can be configured to save data at 1 minute intervals up to 120 minutes.

To select your data logging interval, simply go into the MENU screen and select LOGGING INTERVAL. this will prompt you to a screen where you can set the value by minutes. Once selected, press enter and your interval will be saved.

For data logging purposes, it is important to correctly set the date and time so that the time stamp will be saved along with the recorded oxygen value. To set the time and date, refer to section 3.2.

3.10 Output Simulation

Contact the factory for more detail about simulating the output on the OMD-525X.

3.101 Output Calibration

Contact the factory for more detail about calibrating the output on the OMD-525X.

4.1 Span Calibration using Ambient Air

Calibration involves using a known span gas to match and adjust the oxygen sensor / analyzer combo to a known value. This can be as simple as using ambient air, which tends to be a constant 20.9%, which is what we will focus on for section 4.1. For calibrating with a certified SPAN Gas, please proceed to section 4.2. For a recommendation on which type of calibration is best for your process consult the factory.

Calibration using Ambient Air:

If using ambient air to calibrate the sensor, it is recommended to read through the calibration procedure prior to performing an air calibration to make sure all instructions are understood. Consult the factory if any questions arise.

If the sensor is already installed in the sensor housing, you will need to connect the gas sample line as noted in section 2.4 or expose the sensor to ambient air which is typically 20.9%. With the flow through sensor housing you can open up the housing and with two fingers hold the sensor to the top portion of the housing, making sure the sensor contacts are firmly touching the gold pogo pins in the housing. Make sure the sensor screen of the oxygen sensor is facing the ground for optimum results.

Let the reading stabilize for about 30 - 45 seconds and then proceed to the following steps in the OMD-525X menu:

SPAN CALIBRATION: To calibrate the transmitter, press the MENU key then use the UP/DOWN keys to highlight the SPAN CAL option and press the ENTER key.

Use the UP / DOWN keys to adjust the reading on the display until it matches the value of your SPAN Gas. For example if your SPAN gas is 20.9% adjust the display UP or DOWN until it reads 20.9%.

Press the ENTER key and the display will show "PASSED" or "FAILED." If passed, promptly put the sensor in a zero or low oxygen gas. This will help extend the life of the sensor and speed of response. If failed, repeat calibration steps or consult the factory.

Trace Oxygen Sensor Caution: The sensor should not be exposed to ambient air for more than 2 minutes. This will help speed of response, sensor life, and low end sensitivity.

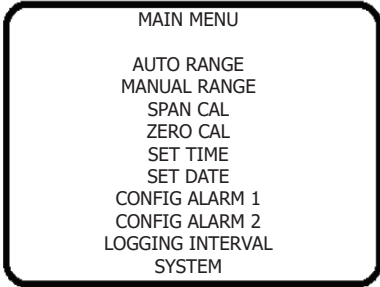

MAIN MENU
AUTO RANGE
MANUAL RANGE
SPAN CAL
ZERO CAL
SET TIME
SET DATE
CONFIG ALARM 1
CONFIG ALARM 2
LOGGING INTERVAL
SYSTEM



20.9%

UP TO INCREASE
DOWN TO DECREASE
ENTER TO CAL
ESC TO EXIT

4.2 Span Calibration using a Certified Span Gas

Calibration involves using a known span gas to match and adjust the oxygen sensor / analyzer combo to a known value. This can be as simple as using ambient air that tends to be a constant 20.9% or a bottle of certified span gas from your local air separation company. For this section, we will focus on using a certified span gas from your local air separation company. When using a certified bottle, it is recommended to get a span gas equal to 90% or higher of the range you want to use. If you are measuring in the 0 - 1000ppm range, a 900 ppm nitrogen with a balance of oxygen would be ideal.

For a recommendation on which type of calibration is best for your process consult the factory.

Calibration using Certified Span Gas:

It is recommended to read through the calibration prior to performing an air calibration to ensure all instructions are understood. Consult the factory if any questions arise.

Note: For a new trace oxygen sensor (TO2-1x or TO2-2x), purging with a zero gas for 4 - 6 hours will help the low end stability and response. This is not necessary on a percent or purity sensor.

Connect the gas sample line and set the pressure / flow per section 2.4 of the users manual.

Once the gas is flowing, let the reading stabilize for about 5 - 10 minutes and then proceed (consider longer if sensor is still trending down, very important when trying to calibrate with a low span gas such as 5 ppm o₂ / balance nitrogen).

SPAN CALIBRATION: To calibrate the indicator, press the MENU key and use the UP/DOWN keys to highlight the SPAN CAL option and press the ENTER key.

Use the UP / DOWN key until the reading on the display matches the value of your SPAN gas. For example, if your SPAN gas is 8.09 ppm adjust the display UP or DOWN until it reads 8.09 ppm.

Press the ENTER key and the display will show "PASSED" or "FAILED." If passed, promptly put the sensor in a zero or low oxygen gas. This will help extend the life of the sensor and speed of response. If failed, repeat calibration steps or consult the factory.

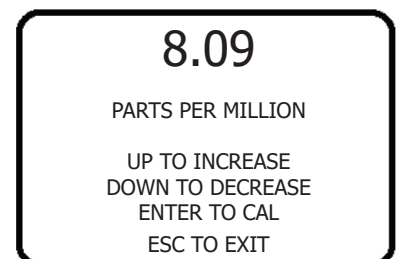
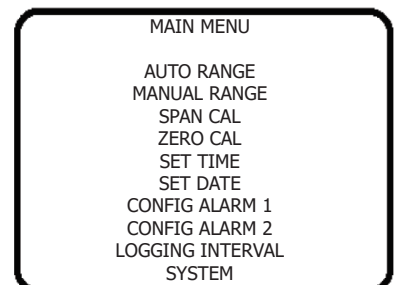

Trace Oxygen Sensor Caution: The sensor should not be exposed to ambient air for more than 2 minutes. This will help speed of response, sensor life, and low end sensitivity.

4.3 Procedure for Replacing the Oxygen Sensor

The characteristics of a precision electrochemical fuel cell are similar to those of a battery. They both provide an output that is nearly constant throughout their useful life and simply fall off sharply towards zero at the end.

If the process sample that is being analyzed is in the low range (0 - 10 ppm) of oxygen concentration, cell failure will be indicated by the inability to properly calibrate the analyzer. The user will also find that very little adjustment of the span calibration feature will be necessary to keep the analyzer in calibration during the sensors useful life. If a large adjustment is needed to calibrate the unit, or calibration cannot be reached, the sensor should immediately be replaced.

**** Note, make sure to read section 2.5 "Installing the Oxygen Sensor" before replacing the sensor.**

No tools are required to replace the sensor. Simply unscrew (counter-clockwise) the collar. Once free, open the top portion of the sensor housing (electronics module) exposing the old oxygen sensor. Remove the old oxygen sensor, disposing of it like you would a lead-acid battery in accordance with your local regulations.

Remove the new sensor from its package and remove the red shorting strip. Place the sensor screen side down in the sensor housing with the copper circuit board pointed up. Proceed to re-connect the collar.

After the sensor has been replaced, proceed to the Span Calibration section and purge with inert gas.

**** Trace oxygen sensors should not be exposed to ambient air for more than a few minutes or their response time and expected life will be adversely affected.**

4.4 Troubleshooting

For troubleshooting and advanced maintenance techniques, please contact your factory representative for assistance.

Email: sales@sso2.com
Ph: 1-949-398-2879

4.5 Zero Calibration

In theory, the oxygen sensor is linear over its measurement range and has no signal output when exposed to an oxygen free environment. However, in reality expect the analyzer to generate a small signal in an oxygen free environment due to one or more of the following:

Minor leakage in the sample gas connections, contamination or quality of zero gas, small amounts of dissolved oxygen in the sensor electrolyte, or tolerance of electronic components in the analyzer.

When is a ZERO Calibration Recommended:

A zero calibration is recommended for online and portable oxygen analyzers in applications where a continuous and precise measurement of oxygen is required below 4.5% of the lowest 2 ranges (i.e. when measuring 0.45 ppm or below on the 0 - 10ppm range and 4.5 ppm or below on the 0 - 100ppm range). A zero calibration is only recommended when these conditions are met and when the user is installing a new oxygen sensor.

For most applications a ZERO calibration is not necessary, if you are unsure if a ZERO calibration is required for your installation, contact the factory and consult with our application specialists for a recommendation.

CAUTION: Prematurely zeroing the analyzer can cause erroneously low readings and extra caution should be taken to make sure a zero calibration is performed accurately.

Determining the zero point is met: the user should allow the analyzer to be purged on zero gas for approximately 24 hours to stabilize the flowing gas. There should be no downward trend of the reading.

Zero Calibration Procedure:

Zero Calibration should precede the span calibration and once performed should not have to be repeated with subsequent span calibrations. The zero calibration should only be performed once, as well as when a new sensor is installed or if changes are made to the sample system connections.

The maximum zero calibration adjustment permitted is 45% of the lowest full scale range availability (roughly 4.5ppm). As such, the analyzer ZERO has not been performed at the factory prior to shipment as the factory gas connections and application conditions are different than the user's installation.

Allow the analyzer to be purged with a zero gas for 24 hours and verify that the oxygen reading is not trending. Once the reading stabilizes and is below 4.5 ppm, proceed to the menu to perform a zero calibration:

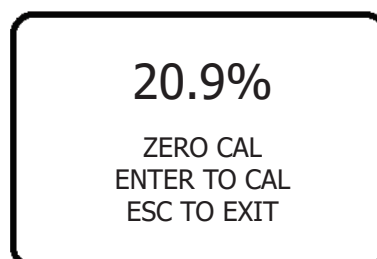
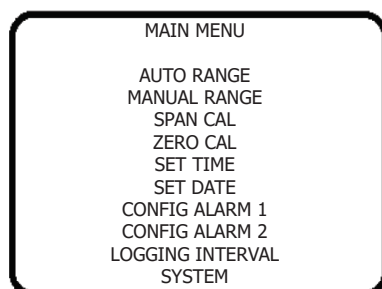

Once the ZERO Calibration procedure is complete, the display will show "PASSED" or "FAILED." If Failed, your reading was most likely above the 4.5ppm threshold or the 24 hour purge on zero gas was not complete. Check your connections and zero gas and verify the unit is stable and not still trending down. Contact the factory for additional troubleshooting techniques.

5.1 Spare Parts List

Spare Parts List - OMD-525X

Replacement Oxygen Sensors:

TO2-1x	PPM Oxygen Sensor (inert gas)
TO2-2x	PPM Oxygen Sensor (CO2 background gas)
PO2-160	Percent Oxygen Sensor (inert gas)
PO2-1120	Long Life Percent Oxygen Sensor
PO2-24	Percent Oxygen Sensor (CO2 background gas)
TO2-19	Hybrid PPM / Percent Oxygen Sensor (inert gas)

Replacement Parts:

PCB-525X-MAIN	Circuit Board for OMD-525X
PCB-525X-PS-AC	Circuit Board for OMD-525X, Power VAC
PCB-525X-PS-DC	Circuit Board for OMD-525X, Power VDC
ORING-1001	Sensor Housing O-ring

For additional troubleshooting or replacement parts, please contact the factory:
sales@sso2.com; Ph: 1-949-398-2879

5.2 Warranty

Oxygen Analyzer / Sensor Warranty

The design and manufacture of our analyzers and precision electrochemical oxygen sensors conforms to established standards and incorporates state of the art materials and components for superior performance while still maintaining minimal cost of ownership. Prior to shipment, every analyzer / sensor is thoroughly tested by the manufacturer. When operated and maintained in accordance with the Owner's Manual, the units will provide many months of reliable service.

Coverage

Under normal operating conditions the analyzers / sensors are warranted to be free of defects in materials and workmanship for the period specified in accordance with the most recent published specifications, said period begins with the date of shipment by the manufacturer. The manufacturer information and serial number of this analyzer / sensor are located visibly on the unit. Southland Sensing Ltd. reserves the right in its sole discretion to invalidate this warranty if the serial number does not appear.

Limitations

Southland Sensing Ltd. will not pay for: loss of time, inconvenience, loss of use, or property damage caused by the oxygen analyzer / sensor or its failure to work.

Exclusions

This warranty does not cover installation, defects resulting from accidents, damage while in transit to our service location, damage resulting from alterations, misuse or abuse, lack of proper maintenance, unauthorized repair or modification of the analyzer, affixing of any label or attachment not provided with the analyzer, fire or flood.

Service

Call Southland Sensing Ltd. at 1-949-398-2879 (or e-mail sales@sso2.com). Trained technicians will assist you in diagnosing the problem.

5.3 Material Safety Data Sheet (MSDS)**Product Identification**

Product Name	Oxygen Sensor Series – PO ₂ , TO ₂ series
Synonyms	Precision Electrochemical Sensor
Manufacturer	Southland Sensing Ltd, 4045 E. Guasti Rd. Suite 203 Ontario, CA 91761
Emergency Phone Number	1-949-398-2879
Preparation / Revision Date	April 23rd, 2016
Notes	Oxygen sensors are sealed, contain protective coverings and in normal conditions do not present a health hazard. Information applies to electrolyte unless otherwise noted.

Specific Generic Ingredients

Carcinogens at levels > 0.1%	None
Others at levels > 1.0%	Potassium Hydroxide or Acetic Acid, Lead
CAS Number	Potassium Hydroxide = KOH 1310-58-3 or Acetic Acid = 64-19-7, Lead = Pb 7439-92-1

General Requirements

Use	Potassium Hydroxide or Acetic Acid - electrolyte, Lead - anode
Handling	Rubber or latex gloves, safety glasses
Storage	Indefinitely

Physical Properties

Boiling Point Range	KOH = 100 to 115 C or Acetic Acid = 100 to 117 C
Melting Point Range	KOH -10 to 0 C or Acetic Acid – NA, Lead 327 C
Freezing Point	KOH = -40 to -10 C or Acetic Acid = -40 to -10 C
Molecular Weight	KOH = 56 or Acetic Acid – NA, Lead = 207
Specific Gravity	KOH = 1.09 @ 20 C, Acetic Acid = 1.05 @ 20 C
Vapor Pressure	KOH = NA or Acetic Acid = 11.4 @ 20 C
Vapor Density	KOH – NA or Acetic Acid = 2.07
pH	KOH > 14 or Acetic Acid = 2-3
Solubility in H ₂ O	Complete
% Volatiles by Volume	None
Evaporation Rate	Similar to water
Appearance and Odor	Aqueous solutions: KOH = Colorless, odorless or Acetic Acid = Colorless, vinegar-like odor

Fire and Explosion Data

Flash and Fire Points	Not applicable
Flammable Limits	Not flammable
Extinguishing Method	Not applicable
Special Fire Fighting Procedures	Not applicable
Unusual Fire and Explosion Hazards	Not applicable

5.3 Cont. Material Safety Data Sheet (MSDS)**Reactivity Data**

Stability	Stable
Conditions Contributing to Instability	None
Incompatibility	KOH = Avoid contact with strong acids or Acetic Acid = Avoid contact with strong bases
Hazardous Decomposition Products	KOH = None or Acetic Acid = Emits toxic fumes when heated
Conditions to Avoid	KOH = None or Acetic Acid = Heat

Spill or leak

Steps if material is released	Sensor is packaged in a sealed plastic bag, check the sensor inside for electrolyte leakage. If the sensor leaks inside the plastic bag or inside an analyzer sensor housing do not remove it without rubber or latex gloves and safety glasses and a source of water. Flush or wipe all surfaces repeatedly with water or wet paper towel (fresh each time). Disposal In accordance with federal, state and local regulations.
-------------------------------	---

Health Hazard Information

Primary Route(s) of Entry	Ingestion, eye and skin contact
Exposure Limits	Potassium Hydroxide - ACGIH TLV 2 mg/cubic meter or Acetic Acid - ACGIH TLV / OSHA PEL 10 ppm (TWA), Lead - OSHA PEL .05 mg/cubic meter
Ingestion	Electrolyte could be harmful or fatal if swallowed. KOH = Oral LD50 (RAT) = 2433 mg/kg or Acetic Acid = Oral LD50 (RAT) = 6620 mg/kg
Eye	Electrolyte is corrosive and eye contact could result in permanent loss of vision.
Skin	Electrolyte is corrosive and skin contact could result in a chemical burn.
Inhalation	Liquid inhalation is unlikely.
Symptoms	Eye contact - burning sensation. Skin contact - soapy slick feeling.
Medical Conditions Aggravated	None
Carcinogenic Reference Data	KOH and Acetic Acid = NTP Annual Report on Carcinogens - not listed; LARC Monographs - not listed; OSHA - not listed
Other	Lead is listed as a chemical known to the State of California to cause birth defects or other reproductive harm.

Special Protection

Ventilation Requirements	None
Eye	Safety glasses
Hand	Rubber or latex gloves
Respirator Type	Not applicable
Other Special Protection	None

Special Precautions

Precautions	Do not remove the sensor's protective Teflon and PCB coverings. Do not probe the sensor with sharp objects. Wash hands thoroughly after handling. Avoid contact with eyes, skin and clothing. Empty sensor body may contain hazardous residue.
Transportation	Not applicable

5.4 Certificate of Conformance

Model Number: OMD-525X Oxygen Analyzer
Serial Number: _____

Sensor Selection: () TO2-1x Trace Oxygen Sensor
() TO2-2x Trace Oxygen Sensor CO2 > 0.1%
() TO2-19 Hybrid PPM / Percent Oxygen Sensor
() PO2-160 Percent Oxygen Sensor
() PO2-24 Percent Oxygen Sensor CO2 > 0.1%
() PO2-1120 Long Life Purity Oxygen Sensor

Serial Number: _____

Sensor Housing Selection: H3 Flow Through Sensor Housing
() 1/8" Compression Tube Fittings
() 1/4" Compression Tube Fittings
() 6mm Compression Tube Fittings

Configuration:
Ranges: () 0 - 10ppm, 0 - 100ppm, 0 - 1000ppm, 0 - 10000ppm, 0 - 25%
() 0 - 1%, 0 - 5%, 0 - 10%, 0 - 25%, 0 - 100%
Power: () 100 - 240 VAC Power
() 10 - 28 VDC Power

Analog Output: 4 - 20mA Concentration Output
() 1 - 5 V DC Range ID Output
() 4 - 20 mA DC Range ID Output

Communication: MODBUS RS485 ASCII Bi-Directional Protocol

Alarms: 2 Integral Relay Contacts

Display: Backlight

We certify that the parts shipped to you are manufactured in the USA and conform to all requirements of the Purchase Order. These parts have been manufactured and tested to the highest quality standards and in accordance with all required specifications, instructions and technical drawings.

Date: _____

Signature: _____

5.5 MODBUS RS485 ASCII Bi-Directional Communication Protocol

OMD-525X MODBUS ASCII Protocol

The OMD-525X uses MODBUS ASCII at 19200 Baud, 8 bits of data, 1 stop bit, and Even Parity. The communication settings are not adjustable on the OMD-525X. The MODBUS ID number can be changed on the OMD-525X by pressing the MENU button and going into the MODBUS ID Number sub-menu. This will allow the ID setting to be scrolled up or down between 1 and 99, press ENTER to save the setting. **If the ESC Key is held on Bootup**, the MODBUS ID number is also displayed on the bootup screen. Although the OMD-525X uses MODBUS ASCII protocol, the instrument can easily be read from or written to using Windows Hyperterminal, or Linux puTTY.

MODBUS ASCII structure looks like this:

START FRAME	1 char	Starts with colon ":"
ADDRESS FIELD	2 chars	logical number
FUNCTION CODE	2 chars	As Per Read or Write function
DATA	n chars	Data + length will be filled depending on the message type
ERROR CHECK	2 chars	Error check (LRC)
END FRAME	2 chars	CRLF

The MODBUS ASCII LRC is calculated by adding all data fields together, then negating or inverting the result for a 1s complement, then adding 1 for a 2s complement. The starting colon and ending CR and LF are not included. As an example, command 6 to set OMD-525X unit #1 to 25% manual ranging would be the following command ":010600000001F8". In this example we add each field together, $01+06+00+00+00+01 = 8$ or 0000 1000 in binary. The 1s complement is therefore 1111 0111, and adding 1 more gives the 2s complement, which would be 1111 1000 or F8 in Hexadecimal.

The OMD-525X will respond to MODBUS commands 4, 6, and 16. It will also echo back command 3 and 5 for communications testing. In this example the OMD-525X is being polled and echoing back, ":010500000000FA(CR,LF)" using Modbus Poll software.

5.5_2 MODBUS RS485 ASCII Bi-Directional Communication Protocol

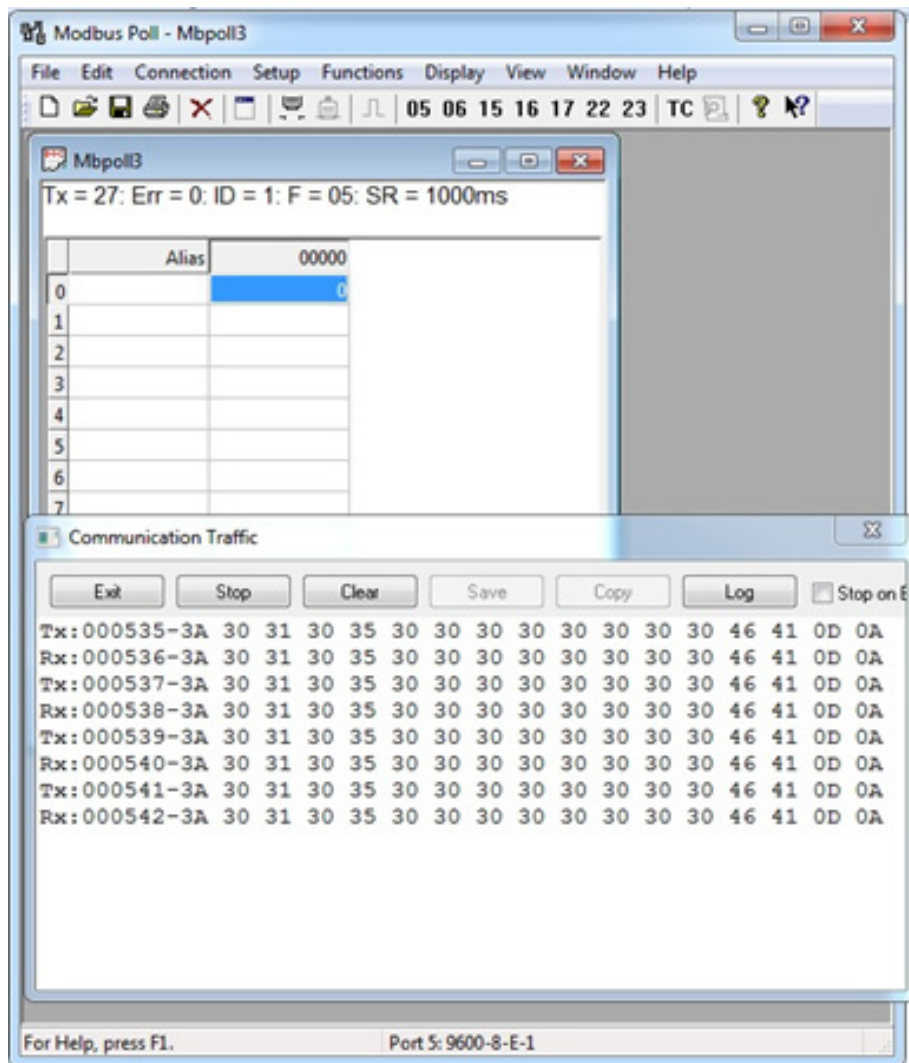

Gas concentration when read from or when written to the OMD-525X is in PPM, as XX XX XX.XX, ie. 19.34 PPM Oxygen on the display would be 000019.34 and would appear as 00001934.

Command 4 is for reading input registers, we use this when reading gas concentration. This will return the gas concentration in PPM, regardless of the manual range setting. The MODBUS command to read input registers is as follows, ":010400000004F7".

- ":" Start byte,
- "01" Device ID,
- "04" Function – Read Input Registers,
- "00" 1st Register High Byte,
- "00" 1st Register Low Byte,
- "00" Number of Registers Hi Byte,
- "04" Number of Registers Low Byte,
- "F7" Longitudinal Redundancy Check (LRC)

5.5_3 MODBUS RS485 ASCII Bi-Directional Communication Protocol

Command 4 will return the gas concentration, the following example is for MODBUS ID #1, and is returning 87.52 PPM, " :010404000087526C"

":" Start byte,
 "01" Device ID,
 "04" Function – Read Input Registers,
 "04" Byte Count – Always 4 bytes
 "00", Data Byte Hi, #1
 "00", Data Byte Lo, #1
 "87", Data Byte Hi, #2
 "52", Data Byte Lo, #2
 "6C", Longitudinal Redundancy Check (LRC)

The returned LRC is calculated by the instrument as follows:

$01+04+04+00+00+87+52 = 148$ or 94 Hex or 1001 0100 Binary
 1's compliment = 0110 1011 = 6B Hex
 2's compliment = 6B H + 1 = 6C Hex

A second example is Command 4 to read the gas concentration from MODBUS ID #2. The read command would be " :020400000004F6", the response would be " :0204040019529352" which would be returning 1952.93 PPM from ID #2.

":" Start byte,
 "02" Device ID,
 "04" Function – Read Input Registers,
 "04" Byte Count – Always 4 bytes
 "00", Data Byte Hi, #1
 "19", Data Byte Lo, #1
 "52", Data Byte Hi, #2
 "93", Data Byte Lo, #2
 "52", Longitudinal Redundancy Check (LRC)

The returned LRC is calculated by the instrument as follows:

$02+04+04+00+19+52+93 = 174$ or AE Hex or 1010 1110 Binary
 1's compliment = 0101 0001 = 51 Hex
 2's compliment = 51 H + 1 = 52 Hex